

# Cisco Room Kit EQX

## Spare parts list

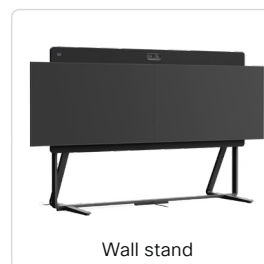
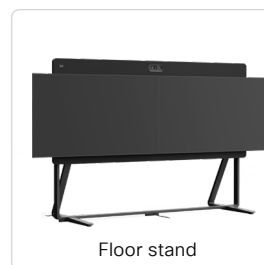
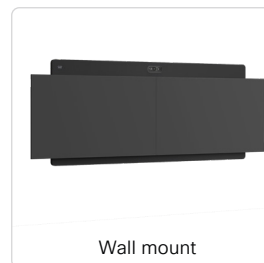

This document lists all spare parts and cables that may be ordered for the *Cisco Room Kit EQX*.

Part numbers (PIDs) are included for all items.

# Contents

Introduction.....	2
Products covered in this guide.....	2
Ordering information.....	2
Spare parts.....	3
Wall mount kit details.....	7
Wall stand kit details.....	8
Floor stand kit details.....	9
Center module kit details.....	10
Front frame kit details.....	11
Cables.....	12
HDMI and presentation cables.....	12
Ethernet cables.....	12
Speaker and microphone cables.....	12
Power cables.....	12
Region-specific power cables.....	13
Spare part replacement.....	14
Cisco contacts.....	15

# Introduction

## Products covered in this guide

This document lists all spare parts and cables that may be ordered for *Cisco Room Kit EQX*.

## Part numbers for complete systems

- CS-KIT-EQX-C-K9
- CS-KIT-EQX-C-NR-K9 (no-radio)
- CS-KIT-EQX-C-K9++ (TAA)
- CS-KIT-EQX-CNRK9++ (no-radio, TAA)
- CS-KIT-EQX-C-K9-- (customized model)
- CS-KIT-EQX-CNRK9-- (no-radio, customized model)

## Part numbers for mounting kits

- CS-KIT-EQX-WMK-C (wall mount kit)
- CS-KIT-EQX-WSK-C (wall stand kit)
- CS-KIT-EQX-FSK-C (floor stand kit)

## Part numbers for spare parts and cables

The part numbers (PIDs) for all spare parts and cables that may be ordered for these products are shown in the tables on the following pages. Also the mounting kits are available as spares.

## Ordering information



To place an order, please contact your local Cisco representative or Cisco partner and refer to part numbers as listed in this document.

## Cisco service and support



Cisco and our partners provide a broad portfolio of smart, personalized services and support. For more information about these services, visit:

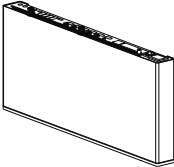
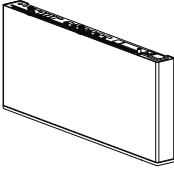
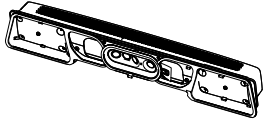
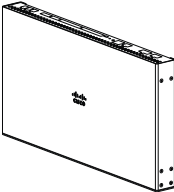

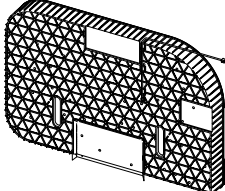
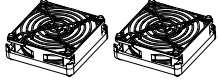

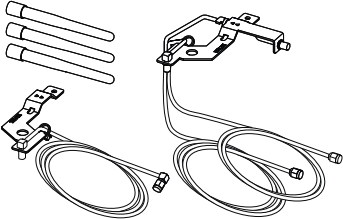
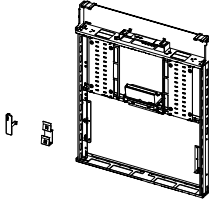
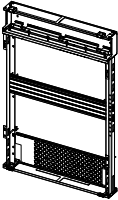
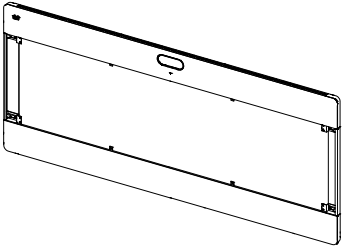
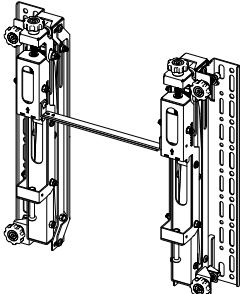

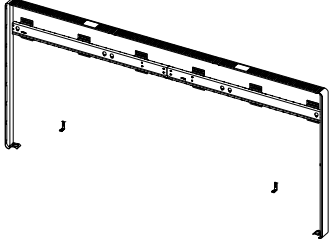
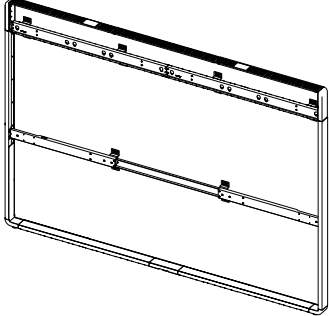
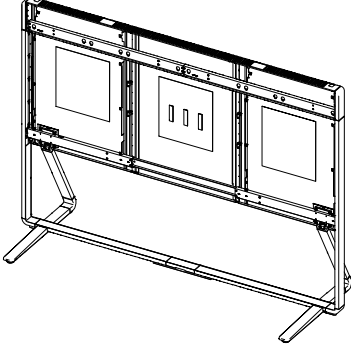
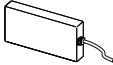
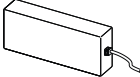

<https://www.cisco.com/go/collaborationservices>

# Spare parts

Part number (PID)	Part description
CS-CODEC-EQ=	 <p>Codec EQ</p>
CS-CODEC-EQ-NR=	 <p>Codec EQ (no-radio)</p>
CS-RQUADCAM=	 <p>Quad Camera for Room Kit EQX</p>
CS-PANO-DNAM4=	 <p>Digital Natural Audio Module IV - amplifier</p>
CS-PANO-SPKR=	 <p>One main speaker</p>
CS-PANO-BASS=	 <p>Bass unit</p>
CS-EQX-FAN=	 <p>Fan kit (two fans with cables included; fan duct not included)</p>

Part number (PID)	Part description	
CS-EQX-ANT=		Wi-Fi and Bluetooth antenna kit (three whip antennas, cables attached to brackets, and screws for fastening the brackets to the frame included)
CS-EQX-CENTER-MOD=		Center module kit with the center module, fan duct, and brackets. See <a href="#">page 10</a> for details
CS-EQX-SIDE-MOD=		One side module (can be used both for the left and right sides)
CS-EQX-FRAME-C=		Front frame kit with grilles, deco ring, and side panels. See <a href="#">page 11</a> for details
CS-EQX-VESA=		VESA-bracket for one screen (includes two interface arms and an adjustable brace)

Part number (PID)	Part description	
CS-KIT-EQX-WMK-C=		Wall mount kit, see <a href="#">page 7</a> for details. These parts are used only for Room Kit EQX mounted on the wall
CS-KIT-EQX-WSK-C=		Wall stand kit, see <a href="#">page 8</a> for details. These parts are used only for Room Kit EQX mounted on a wall stand
CS-KIT-EQX-FSK-C=		Floor stand kit, see <a href="#">page 9</a> for details. These parts are used only for Room Kit EQX mounted on a floor stand
PSU-12VDC-120W=		Power supply, AC/DC, 12V, 120W. This is one of the two PSUs that connects to the amplifier; PSU-24VDC-270W= is the other
PSU-24VDC-270W=		Power supply, AC/DC, 24V, 270W. This is one of the two PSUs that connects to the amplifier; PSU-12VDC-120W= is the other.
CS-PWR-STRIP4=		Power strip (one C14 inlet, four type F outlets)

Part number (PID)	Part description
CS-T10-TS-L-K9=	 <p>Room Navigator (10 inch touch user interface), white, without cable</p>
CS-MIC-TABLE-J=	 <p>Cisco Table Microphone (cable with mini-jack connector included)</p>
CS-MIC-ARRAY-T=	 <p>Cisco Table Microphone Pro (cable with RJ-45 connector included)</p>
CS-EQX-SCRW=	<p>5x  M6x12, Hex 4 mm</p> <p>5x  M4x8, Torx T20</p> <p>10x  M6x8, Hex 4 mm</p> <p>10x  M4x10, Torx T20</p> <p>10x  Plastic washer</p> <p>5x  Sliding nut</p> <p>Set of screws, washers, and nuts</p>

## Wall mount kit details

(CS-KIT-EQX-WMK-C=)

### Wall mount kit parts

- 1 Carrier beam (two side parts and a joining bracket)
- 2 Six wall mount brackets for the carrier beam
- 3 Two angle brackets
- 4 Two side covers
- 5 Top covers (left, right, and center)

### Screws and nuts



8x  
(M6x12, Hex 4 mm)

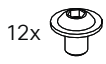

12x  
(M6x8, Hex 4 mm)



4x  
(M4x8, Torx T20)

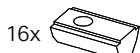

16x  
(Sliding nut)

### Note:

If you already have a Room Kit EQX mounted on a wall stand or floor stand, this wall mount kit contains the parts you need to change to the wall mount option.

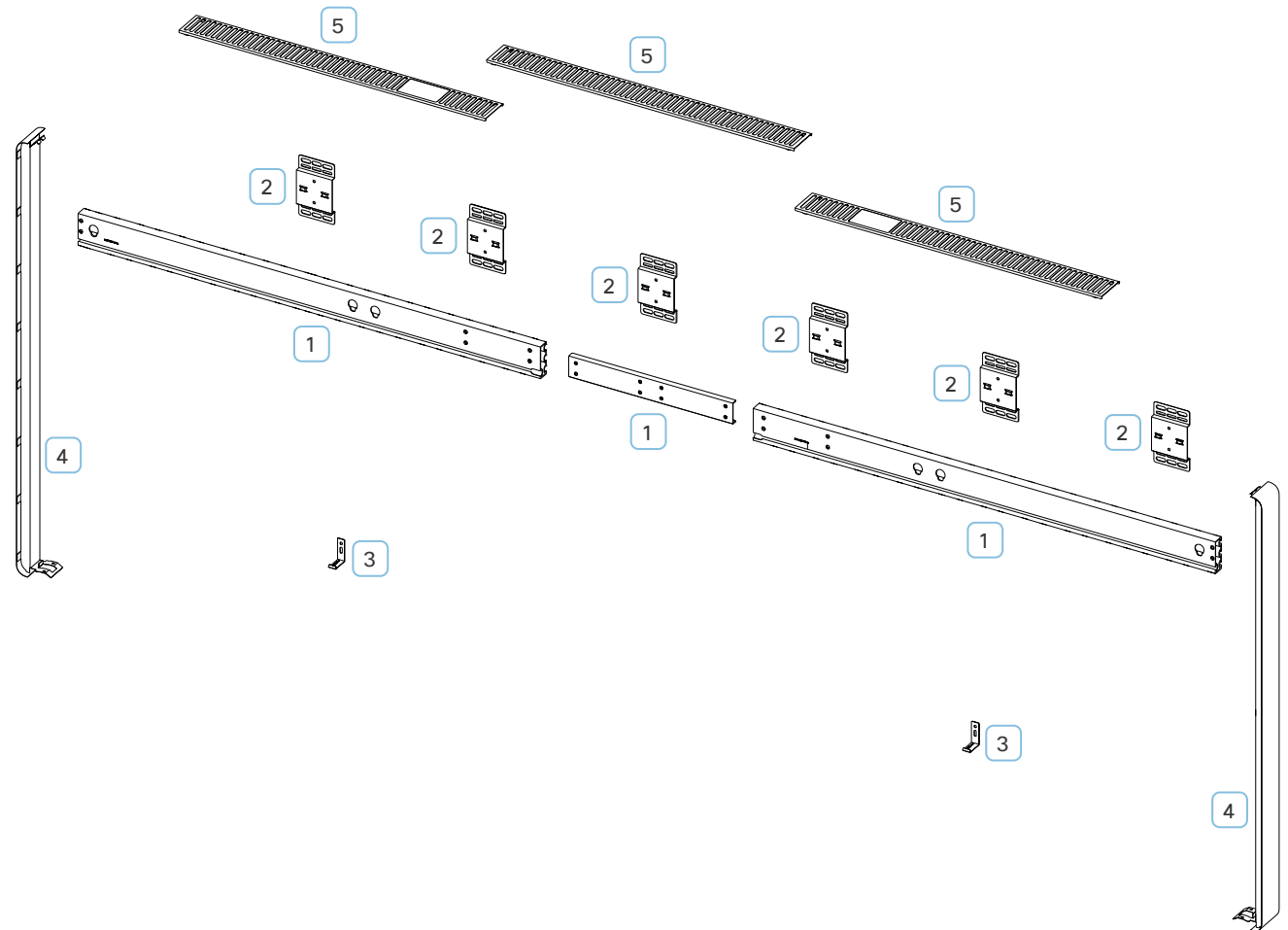

# Wall stand kit details

(CS-KIT-EQX-WSK-C=)

## Wall stand kit parts

- 1 Bottom frame with bumpers (two side parts and a joining bracket)

---

- 2 Two long vertical legs

---

- 3 Two leg tops

---

- 4 Carrier beam (left and right side parts and a joining bracket)

---

- 5 Lower bar (two side parts and a center part)

---

- 6 Six wall mount brackets. Four for the carrier beam and two for the lower bar

---

- 7 Frame covers (two vertical and two horizontal)

---

- 8 Center cable cover

---

- 9 Top covers (left, right, and center)

## Cable clips, screws and nuts

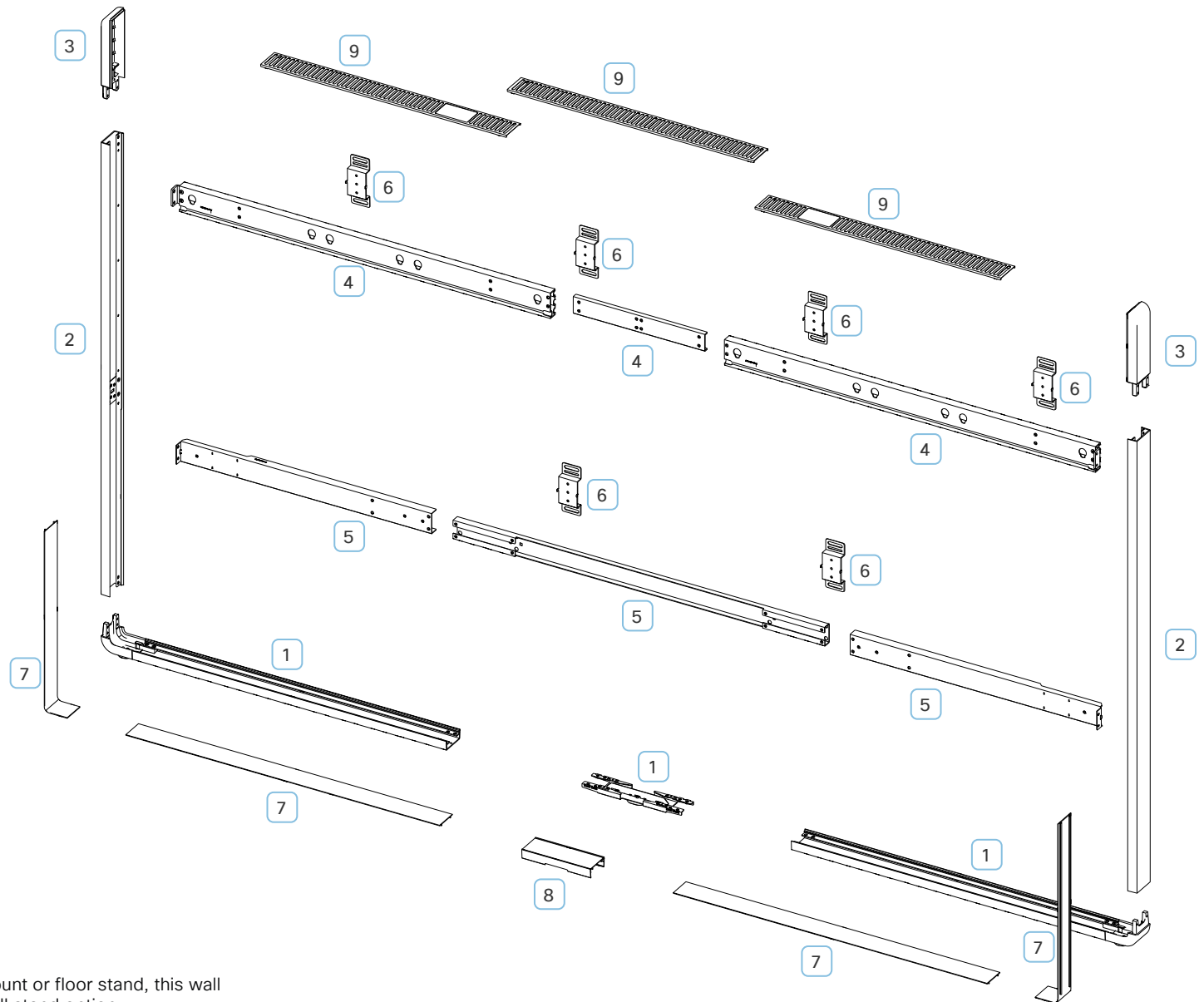
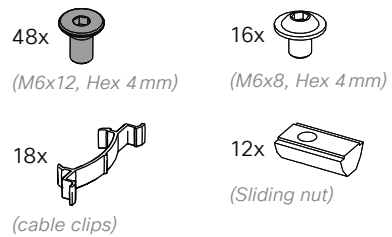

### Note:

If you already have a Room Kit EQX mounted on a wall mount or floor stand, this wall stand kit contains the parts you need to change to the wall stand option.



## Floor stand kit details

(CS-KIT-EQX-FSK-C=)

### Floor stand kit parts

- 1 Bottom frame with bumpers (two side parts, a joining bracket, and a stiffener)
- 2 Two skis
- 3 Two rear legs
- 4 Two long vertical legs
- 5 Two leg tops
- 6 Carrier beam (left and right side parts and a joining bracket)
- 7 Lower bar (two side parts and a center part)
- 8 Frame covers (two vertical, two horizontal, and two for the rear legs)
- 9 Center cable cover
- 10 Rear panels (left, right, and center) including four spacers

### Cable clips, screws and nuts

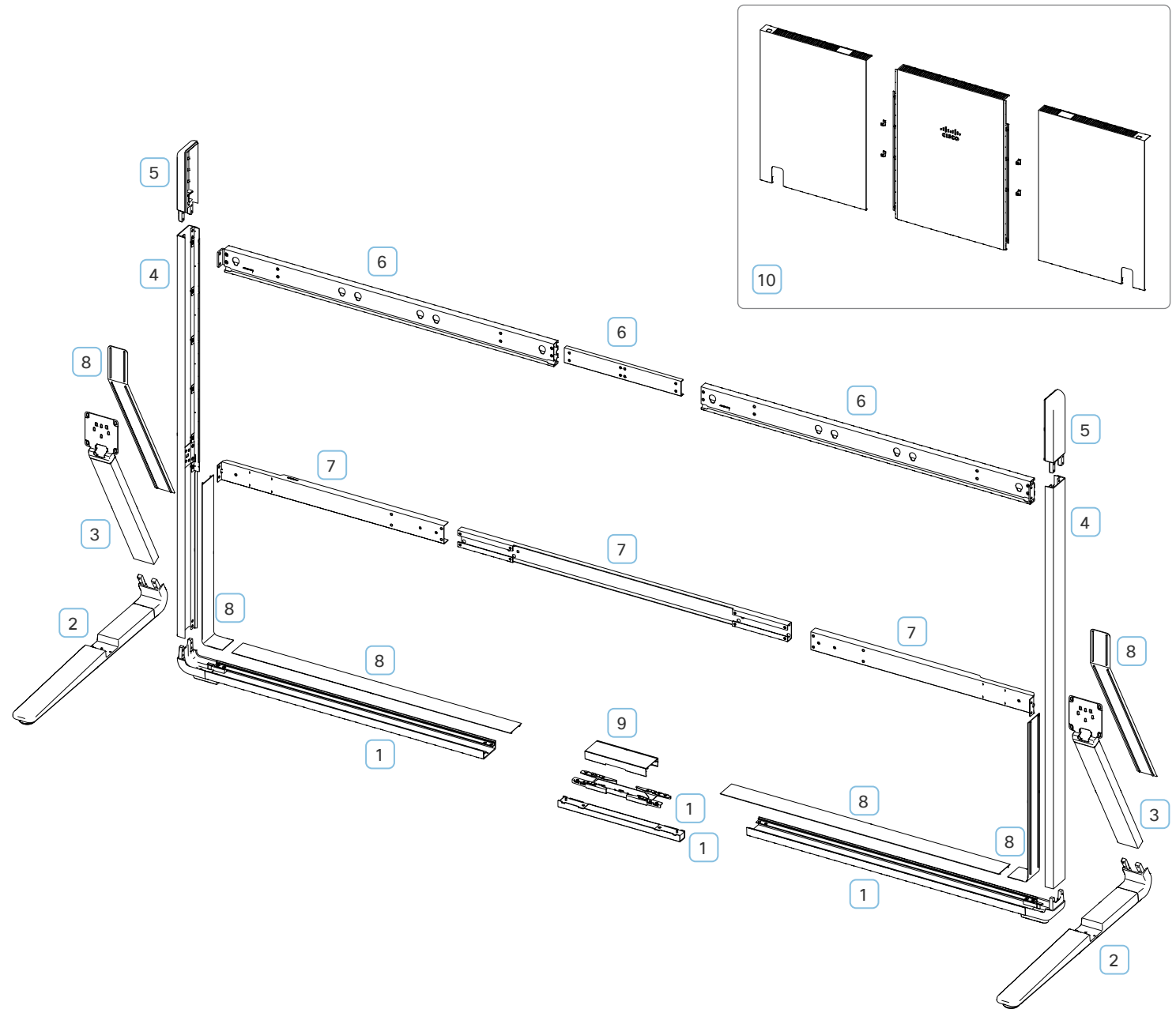
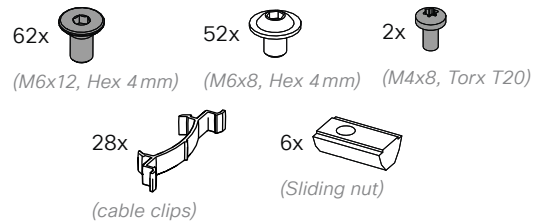

### Note:

If you already have a Room Kit EQX mounted on a wall mount or wall stand, this floor stand kit contains the parts you need to change to the floor stand option.

# Center module kit details

(CS-EQX-CENTER-MOD=)

## Center module kit parts

- 1 Center module

---

- 2 Power strip bracket

---

- 3 PSU bracket

---

- 4 Fan duct (top and bottom). Fans are not included in this kit. The fans are in CS-EQX-FAN=

---

- 5 Two top brackets

## Screws

- |                          |                         |
|--------------------------|-------------------------|
| 8x<br>(M6x8, Hex 4mm)    | 21x<br>(M4x8, Torx T20) |
| 12x<br>(M4x10, Torx T20) |                         |

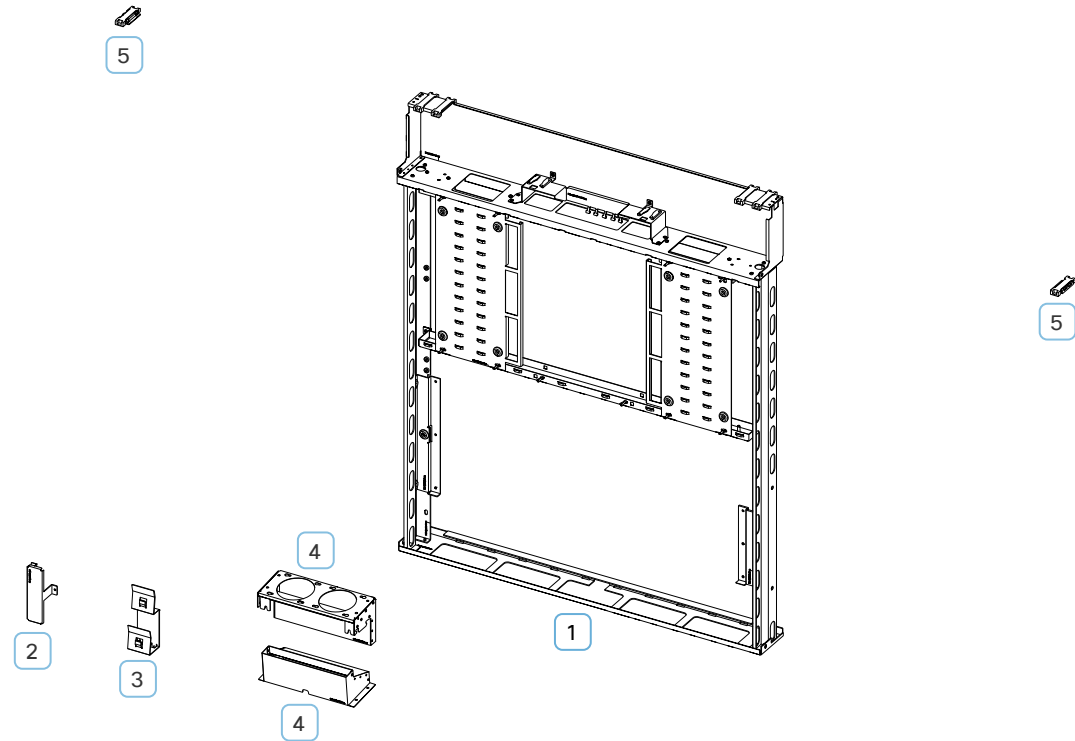



# Front frame kit details

(CS-EQX-FRAME-C=)

## Front frame kit parts

- 1 Corners for both the speaker grille and bottom grille
- 2 Stiffeners for both the speaker grille and bottom grille
- 3 Top panels for the speaker grille (two side panels and a center panel)
- 4 Bottom panels for the bottom grille (left and right side panels and a center panel)
- 5 Textile speaker grille
- 6 Textile bottom grille
- 7 Deco ring around the camera
- 8 Two side panels

## Screws and washers

- 8x  (M6x8, Hex 4mm)
- 70x  (M4x10, Torx T20)
- 66x  (Plastic washer)

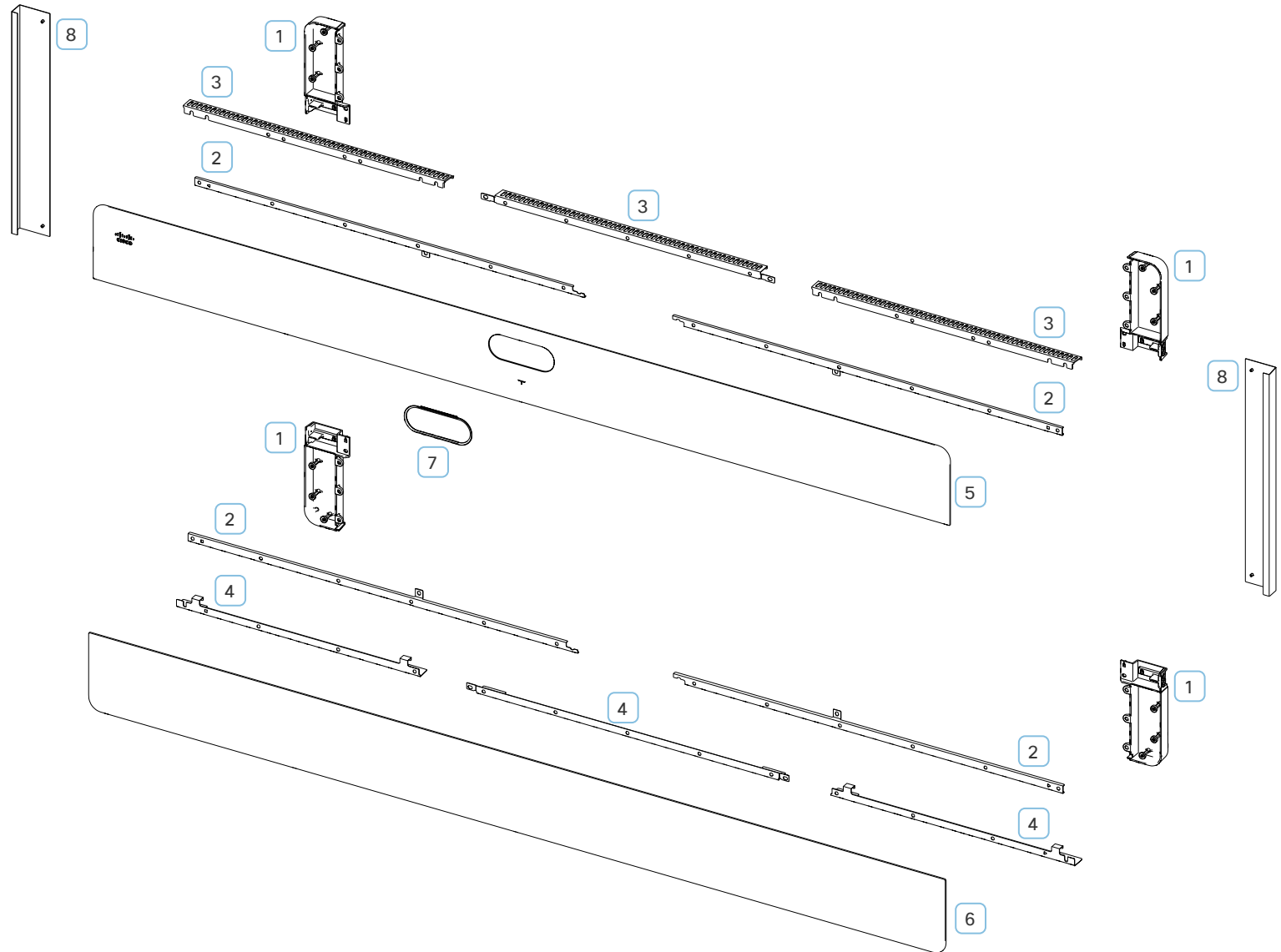

# Cables

## HDMI and presentation cables

Part number (PID)	Part description	Number printed on cable
CAB-2HDMI-1.5M-GR=	HDMI cable between codec and camera, grey, 1.5m	72-101006-xx
CAB-2HDMI-4M-GR=	HDMI cable between codec and left screen, grey, 4 m	72-101809-xx
CAB-2HDMI-2.06M=	HDMI cable between codec and right screen, grey, 2.06m (short alternative, included in early shipments)	72-101333-xx
CAB-2HDMI-3M-GR=	HDMI cable between codec and right screen, grey, 3 m (longer alternative)	72-101007-xx
CAB-HDMI-MUL4K-9M=	Presentation cable, multihead, 4K, HDMI to USB-C/HDMI/miniDP, 9m	72-101342-xx
CAB-PRES-2HDMI-GR=	Presentation cable, HDMI 1.4b, with repeater, grey, 8m	72-101034-xx
CAB-USBC-AC-9M=	Presentation cable, USB-C 3.1, active optical cable, USB charging, 9m	74-124924-xx

## Ethernet cables

Part number (PID)	Part description	Number printed on cable
CAB-ETH-5M-GR=	Ethernet cable between codec and LAN (wall socket), grey, 5m	72-101005-xx
CAB-ETH-1.5M-GR=	Ethernet cable between codec and camera (camera control) and between codec and amplifier, grey, 1.5m	72-101204-xx
CAB-CAT5E-12M=	Ethernet cable for Room Navigator, grey, 12 m	72-101875-xx

## Speaker and microphone cables

Part number (PID)	Part description	Number printed on cable
CAB-EQX-SPKR=	Cable bundle for speakers (6 speakers + 1 bass)	72-102227-xx
CAB-MIC-EXT-J=	Extension cable for Table Microphone (mini-jack), 9m	72-101457-xx

## Power cables

Part number (PID)	Part description	Number printed on cable
PWR-CAB-INT-1.45M=	Power cable from amplifier to camera, 1.45m	72-102303-xx
PWR-CAB-INT-0.22M=	Power cable from power strip to 24V PSU and from power strip to 12V PSU (C13 to C14, 10A, 0.22m)	37-101318-xx
PWR-CAB-INT-3.0M=	Power cable from power strip to codec (C13 to C14, 10A, 3m)	37-0833-xx

## Region-specific power cables

Part number (PID)	Part description
PWR-CORD-ARG-F=	Power cord (C13, 5 m, 10A) for Argentina
PWR-CORD-AUS-F=	Power cord (C13, 5 m, 10A) for Australia
PWR-CORD-BRA-F=	Power cord (C13, 5 m, 10A) for Brazil
PWR-CORD-CHE-F=	Power cord (C13, 5 m, 10A) for Switzerland
PWR-CORD-CHN-F=	Power cord (C13, 5 m, 10A) for China
PWR-CORD-DNK-F=	Power cord (C13, 5 m, 10A) for Denmark
PWR-CORD-EUR-F=	Power cord (C13, 5 m, 10A) for Europe
PWR-CORD-GBR-F=	Power cord (C13, 5 m, 10A) for United Kingdom

Part number (PID)	Part description
PWR-CORD-IND-F=	Power cord (C13, 5 m, 10A) for India
PWR-CORD-ISR-F=	Power cord (C13, 5 m, 10A) for Israel
PWR-CORD-ITA-F=	Power cord (C13, 5 m, 10A) for Italy
PWR-CORD-JPN-F=	Power cord (C13, 5 m, 10A) for Japan
PWR-CORD-KOR-F=	Power cord (C13, 5 m, 10A) for South Korea
PWR-CORD-TWN-F=	Power cord (C13, 5 m, 10A) for Taiwan
PWR-CORD-USA-F=	Power cord (C13, 4.5 m, 10A) for United States of America
PWR-CORD-ZAF-F=	Power cord (C13, 5 m, 10A) for South Africa

# Spare part replacement

The following documents are useful when replacing parts.

<https://www.cisco.com/go/room-kit-eqx-installation>

- Cisco Room Kit EQX Wiring Diagram
- Cisco Room Kit EQX Installation Guide, wall mount option
- Cisco Room Kit EQX Installation Guide, wall stand option
- Cisco Room Kit EQX Installation Guide, floor stand option

## Cisco contacts

On our web site you will find an overview of the worldwide Cisco contacts.

Go to: <https://www.cisco.com/go/offices>

Corporate Headquarters  
Cisco Systems, Inc.  
170 West Tasman Dr.  
San Jose, CA 95134 USA

### Intellectual property rights

THE SPECIFICATIONS AND INFORMATION REGARDING THE PRODUCTS IN THIS MANUAL ARE SUBJECT TO CHANGE WITHOUT NOTICE. ALL STATEMENTS, INFORMATION, AND RECOMMENDATIONS IN THIS MANUAL ARE BELIEVED TO BE ACCURATE BUT ARE PRESENTED WITHOUT WARRANTY OF ANY KIND, EXPRESS OR IMPLIED. USERS MUST TAKE FULL RESPONSIBILITY FOR THEIR APPLICATION OF ANY PRODUCTS.

THE SOFTWARE LICENSE AND LIMITED WARRANTY FOR THE ACCOMPANYING PRODUCT ARE SET FORTH IN THE INFORMATION PACKET THAT SHIPPED WITH THE PRODUCT AND ARE INCORPORATED HEREIN BY THIS REFERENCE. IF YOU ARE UNABLE TO LOCATE THE SOFTWARE LICENSE OR LIMITED WARRANTY, CONTACT YOUR CISCO REPRESENTATIVE FOR A COPY.

The Cisco implementation of TCP header compression is an adaptation of a program developed by the University of California, Berkeley (UCB) as part of UCB's public domain version of the UNIX operating system. All rights reserved. Copyright © 1981, Regents of the University of California.

NOTWITHSTANDING ANY OTHER WARRANTY HEREIN, ALL DOCUMENT FILES AND SOFTWARE OF THESE SUPPLIERS ARE PROVIDED "AS IS" WITH ALL FAULTS. CISCO AND THE ABOVE-NAMED SUPPLIERS DISCLAIM ALL WARRANTIES, EXPRESSED OR IMPLIED, INCLUDING, WITHOUT LIMITATION, THOSE OF MERCHANTABILITY, FITNESS FOR A PARTICULAR PURPOSE AND NONINFRINGEMENT OR ARISING FROM A COURSE OF DEALING, USAGE, OR TRADE PRACTICE.

IN NO EVENT SHALL CISCO OR ITS SUPPLIERS BE LIABLE FOR ANY INDIRECT, SPECIAL, CONSEQUENTIAL, OR INCIDENTAL DAMAGES, INCLUDING, WITHOUT LIMITATION, LOST PROFITS OR LOSS OR DAMAGE TO DATA ARISING OUT OF THE USE OR INABILITY TO USE THIS MANUAL, EVEN IF CISCO OR ITS SUPPLIERS HAVE BEEN ADVISED OF THE POSSIBILITY OF SUCH DAMAGES.

Any Internet Protocol (IP) addresses and phone numbers used in this document are not intended to be actual addresses and phone numbers. Any examples, command display output, network topology diagrams, and other figures included in the document are shown for illustrative purposes only. Any use of actual IP addresses or phone numbers in illustrative content is unintentional and coincidental.

All printed copies and duplicate soft copies are considered un-Controlled copies and the original on-line version should be referred to for latest version.

Cisco has more than 200 offices worldwide. Addresses, phone numbers, and fax numbers are listed on the Cisco website at [www.cisco.com/go/offices](http://www.cisco.com/go/offices).

Cisco and the Cisco logo are trademarks or registered trademarks of Cisco and/or its affiliates in the U.S. and other countries. To view a list of Cisco trademarks, go to this URL: [www.cisco.com/go/trademarks](http://www.cisco.com/go/trademarks). Third-party trademarks mentioned are the property of their respective owners. The use of the word partner does not imply a partnership relationship between Cisco and any other company. (1110R)

### Cisco product security overview

This product contains cryptographic features and is subject to United States and local country laws governing import, export, transfer, and use. Delivery of Cisco cryptographic products does not imply third-party authority to import, export, distribute, or use encryption. Importers, exporters, distributors, and users are responsible for compliance with U.S. and local country laws. By using this product you agree to comply with applicable laws and regulations. If you are unable to comply with U.S. and local laws, return this product immediately.

Further information regarding U.S. export regulations may be found at <http://www.bis.doc.gov/policiesandregulations/ear/index.htm>.