



# Cisco Preferred Architecture for Video 11.5

Design Overview

Revised: June 14, 2016



# Contents

- Preface** .....4
  - Documentation for Cisco Preferred Architectures .....4
  - About This Guide .....5
- Introduction** .....6
  - Technology Use Cases .....6
  - Architectural Overview .....6
  - Cisco Business Edition 6000.....8
    - High Availability .....9
- Endpoints** .....10
  - Recommended Deployment.....11
- Call Control** .....12
  - Recommended Deployment.....13
  - Benefits .....13
  - Deployment Best Practices .....13
    - Cisco Unified Communications Manager and IM and Presence Service .....13
    - Dial Plan .....14
    - Admission Control.....16
    - Multi-Cluster Deployment Considerations.....17
- Conferencing** .....18
  - Recommended Deployment.....19
  - Benefits .....19
  - Deployment Best Practices .....20
    - Instant Video Conferencing .....20
    - Permanent Conferences with Cisco Collaboration Meeting Rooms (CMR) Premises .....20
    - Scheduled Video Conferences .....22
    - Collaboration Meeting Rooms Hybrid (CMR Hybrid) .....22
    - Collaboration Meeting Rooms Cloud (CMR Cloud) .....23
  - Support for Multiple Call Processing Sites .....24
  - Cisco TelePresence Management Suite and Extensions.....25
    - Recommended Deployment .....25
    - Benefits.....26
- Collaboration Edge** .....27
  - Recommended Deployment.....28
  - Benefits .....28
  - Deployment Best Practices .....28
    - Cisco Expressway .....28
    - Connectivity for Audio and Video over the Internet.....29
    - ISDN Connectivity for Video .....30
    - H.323 Endpoints and Connectivity.....30
    - Integrating with Microsoft Lync .....30
- Applications** .....31
  - Cisco Prime Collaboration.....32
    - Recommended Deployment .....32
    - Benefits.....32

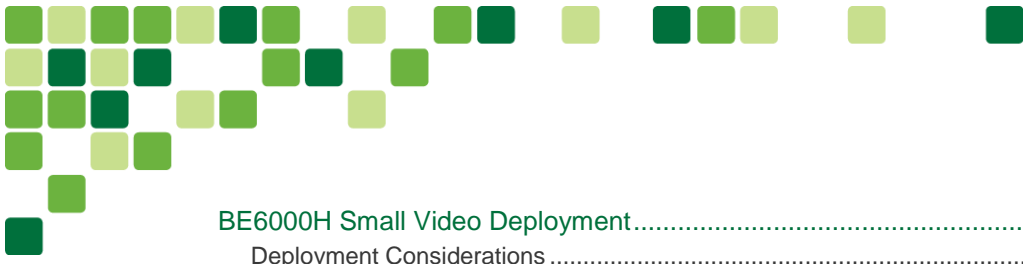

BE6000H Small Video Deployment.....	33
Deployment Considerations .....	33
Appendix.....	34
Product List.....	34

# Preface

Cisco Preferred Architectures provide recommended deployment models based on common use cases. They incorporate a subset of products from the total Cisco Collaboration portfolio that is best suited for the targeted technology and defined use cases. These deployment models are prescriptive, out-of-the-box, and built to scale with an organization as its business needs change. This prescriptive approach simplifies the integration of multiple system-level components and enables an organization to select the deployment model that best addresses its business needs.

## Documentation for Cisco Preferred Architectures

- [Cisco Preferred Architecture \(PA\) Design Overview](#) guides help customers and sales teams select the appropriate architecture based on an organization’s business requirements; understand the products that are used within the architecture; and obtain general design best practices. These guides support pre-sales processes.
- [Preferred Architecture Cisco Validated Design \(CVD\)](#) guides provide details for deploying components within the Cisco Preferred Architectures. These guides support planning, deployment, and implementation (PDI).
- [Preferred Architecture Application Cisco Validated Design \(CVD\)](#) guides provide an application solution to the foundational Preferred Architecture. These guides support planning, deployment, and implementation (PDI).
- [Cisco Solution Reference Network Design \(SRND\)](#) guide provides detailed design options for Cisco Collaboration. This guide should be referenced when design requirements are outside the scope of Cisco Preferred Architectures.

Figure 1 illustrates how to use the guides. As mentioned, this overview is used for the pre-sales process to explain the products and components, while the CVDs are used in the post-sales process for design, deployment, and implementation. The set of Application CVDs covers optional applications that can be deployed on top of the foundational Preferred Architecture.

**Figure 1** Preferred Architecture Documentation Structure





## About This Guide

The Cisco Preferred Architecture for Video is for:

- Sales teams that sell and design video communications environments
- Customers and sales teams who want to understand the overall Cisco video architecture, its components, and general design best practices

Readers of this guide should have a general knowledge of Cisco Voice, Video, and Collaboration products and a basic understanding of how to deploy these products.

This guide simplifies the design and sales process by recommending products and detailing a video architecture while identifying general best practices for deployment in organizations.

For detailed information about configuring, deploying, and implementing this architecture, consult the related CVD documents on the [Design Zone for Collaboration](#).



# Introduction

Today's business environment provides numerous challenges for organizations that are trying to expand business while containing expense. Additionally, organizations are more often geographically dispersed because of mergers and acquisitions. This physical separation of team members creates a compelling need for rich communication tools.

Not long ago, organizations realized the added value that video solutions brought to their business through increased employee productivity and enhanced customer relationships. However, interoperability among video solutions was sparse, and most solutions were difficult to deploy and use. Since then, significant advances have been made in video technology that simplify deployment, improve interoperability, and enhance the overall user experience. Video communication is starting to be widely adopted by individuals in their personal lives. Today's business video solutions offer organizations the ability to easily integrate video, voice, and web participants into a single, unified meeting experience.

## Technology Use Cases

Organizations want to streamline their business processes, optimize employee productivity, and enhance relationships with partners and customers. The Cisco PA for Video delivers capabilities that enable organizations to realize immediate gains in productivity and enhanced relationships. Additionally, the following technology use cases offer organizations opportunities to develop new, advanced business processes that deliver even more value in these areas:

- **Incorporate video into meetings** — Improve communications, relationships, and productivity by making it easier to meet face-to-face over distance.
- **Extend telephony with video** — Facilitate face-to-face video communications directly from your phone or softphone application.
- **Support teleworkers and branch offices** — Let employees work from multiple locations, whether satellite offices, home offices, or when traveling.
- **Collaborate with external organizations** — Easily share information, interact in real time, and communicate across channels beyond email and telephone.

Information about Cisco Video Technologies and use cases is available on [Cisco.com](https://www.cisco.com).

## Architectural Overview

The Cisco PA for Video provides an end-to-end video solution for deployments of up to 1,000 users and 2,500 video endpoints. This architecture incorporates high availability for critical applications and uses products developed and priced for small to large video deployments. The consistent user experience provided by the overall architecture facilitates quick user adoption, enabling an organization to recognize immediate value for its investment. Additionally, the architecture supports an advanced set of video services that extend to mobile workers, partners, and customers through the following key services:

- High definition video and content sharing
- Rich media conferencing
- Enablement of mobile and remote workers
- Business-to-business video communications
- Integration of on-premises and cloud video solutions

The Cisco PA for Video is designed to work with your existing voice platform – whether from Cisco or another vendor – or as a standalone video solution. Connecting voice and video architectures breaks down barriers to unified communications and prevents unnecessary technology islands within an organization.



Because of the adaptable nature of Cisco endpoints and their support for IP networks, this architecture enables an organization to use its current data network to support video calls. It is essential to ensure a collaboration solution is deployed with proper quality of service (QoS) configured throughout the network. Voice and video IP traffic should be classified and prioritized to preserve the user experience and avoid negative effects such as delay, loss, and jitter. For more information about LAN and WAN QoS, see the [Cisco Collaboration SRND](#).

The Cisco PA for Video, shown in [Figure 2](#), provides highly available and secure centralized services. These services extend easily to remote offices and mobile workers, providing availability of critical services. Additionally, centralizing services simplifies management and administration of an organization's video deployment.

**Figure 2** Cisco Preferred Architecture for Video

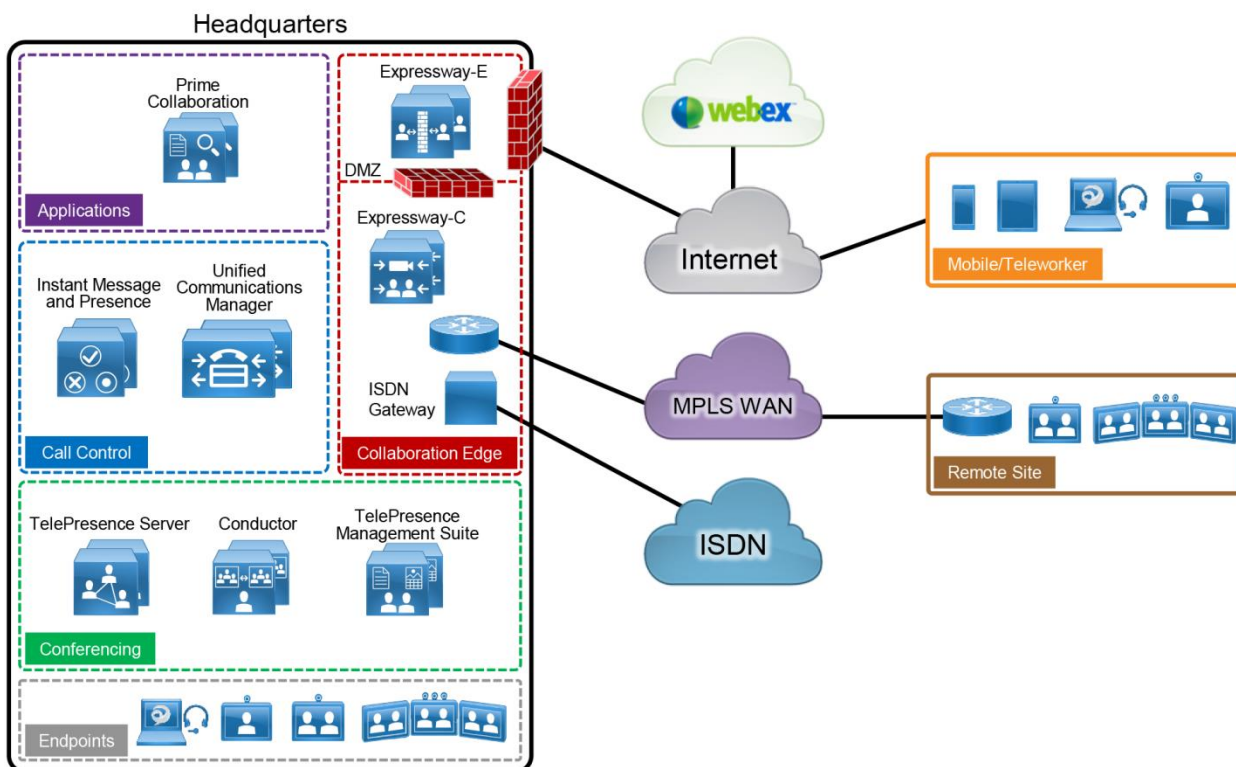

**Table 1** lists the products in this architecture. For simplicity, products are grouped into modules to help categorize and define their roles. The content in this guide is organized in the same modules.

**Table 1** Components for the Cisco Preferred Architecture for Video

Module	Component	Description
<b>Call Control</b>	Cisco Unified Communications Manager (Unified CM)	Provides endpoint registration, call processing, and media resource management
	Cisco Unified Communications Manager IM and Presence Service	Provides instant messaging and presence services
	Cisco Integrated Services Router (ISR)	Provides Survivable Remote Site Telephony (SRST) functionality
<b>Endpoints</b>	Cisco video and TelePresence endpoints and Cisco Jabber	Enables real-time voice, video, and content sharing for users
<b>Conferencing</b>	Cisco TelePresence Conductor	Manages conferencing resources
	Cisco TelePresence Server	Provides audio and video conferencing resources
	Cisco TelePresence Management Suite (TMS)	Provides scheduling, web conferencing integration, user portal and, other advanced video features
	Cisco TelePresence Management Suite Extension for Microsoft Exchange (TMSXE)	Enables Cisco TelePresence Management Suite TelePresence scheduling through Microsoft Outlook
<b>Collaboration Edge</b>	Cisco Expressway-C	Enables interoperability with third-party systems and firewall traversal
	Cisco Expressway-E	Supports remote endpoint registration to Cisco Unified CM and enables business-to-business communications
	Cisco TelePresence ISDN Gateway	Enables interoperability with H.320 video endpoints
<b>Applications</b>	Cisco Prime Collaboration Provisioning Standard	Provisions Cisco Unified Communications applications

## Cisco Business Edition 6000

Cisco Business Edition 6000 (BE6000) is a packaged system designed specifically for organizations with up to 1,000 users and 2,500 video devices. Cisco BE6000 is built on a virtualized Cisco Unified Computing System (Cisco UCS) that is prepared and ready for use with a preinstalled virtualization hypervisor and application installation files. This allows quick and easy deployment of the video infrastructure, while maintaining the same rich feature set of much larger deployments. For these reasons the BE6000 is an ideal platform for the Cisco PA for Video. The guidelines in this document are tailored for the BE6000, but they are also relevant for video deployments on other platforms such as the BE7000 or other Cisco UCS models.

For more information about Cisco BE6000, consult the [data sheet](#).

The Cisco PA for Video is built on two Cisco BE6000H servers to provide high availability for applications within the architecture ([Figure 3](#)). Virtualizing multiple applications on a single server lowers cost, minimizes rack space, lowers power requirements, and simplifies deployment and management. Virtualization also accommodates re-deploying hardware and scaling software applications as organizational needs change.



**Figure 3** Cisco Preferred Architecture for Video Deployed on Cisco BE6000H

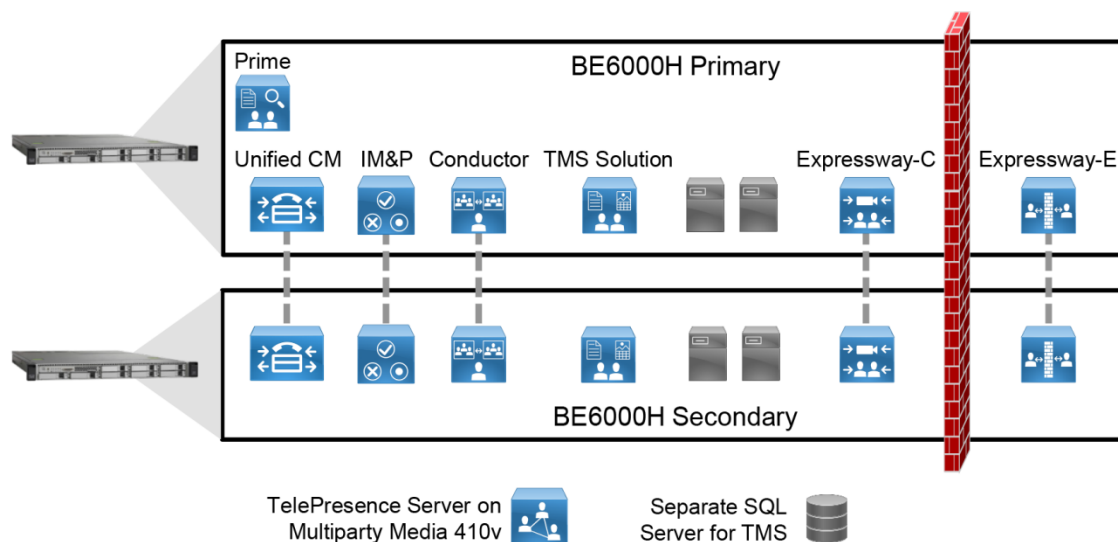

In this architecture, the following applications and Cisco Prime Collaboration Provisioning Standard are deployed on one Cisco BE6000H server, while a second instance of the applications is deployed on a second Cisco BE6000H server to provide hardware and software redundancy for:

- Cisco Unified Communications Manager
- Cisco Unified Communications Manager IM and Presence Service
- Cisco TelePresence Conductor
- Cisco TelePresence Management Suite
- Cisco Expressway, consisting of Expressway-C and Expressway-E

We recommend always deploying redundant configurations to provide the highest availability for critical business applications; however, a non-redundant Cisco BE6000H server configuration may be deployed for organizations that do not require full redundancy. Cisco TelePresence Management Suite Extension for Microsoft Exchange does not support redundancy in this deployment because it resides on the Cisco TMS server.

**Note:** Space is available on the Cisco BE6000H for additional Cisco applications on each BE6000H server.

A smaller deployment with a reduced infrastructure footprint is available, allowing more applications (including TelePresence Server on Virtual Machine) to reside on the BE6000H server. Details about this smaller deployment option are covered in the section on [BE6000H Small Video Deployment](#).

### High Availability

The Cisco PA for Video provides high availability for essential applications by means of the underlying clustering mechanism present in certain Cisco Unified Communications applications.

Clustering replicates the administration and configuration of deployed applications to backup instances of those applications. If an instance of an application fails, Cisco Unified Communications services – such as endpoint registration, call processing, messaging, business-to-business communication, and many others – continue to operate on the remaining instance(s) of the application. This process is transparent to the users. In addition to clustering, the Cisco PA for Video provides high availability through the use of redundant power supplies, network connectivity, and disk arrays.

# Endpoints

Cisco video endpoints provide a wide range of features, functionality, and user experiences. Because endpoints range from desktop video phones and softclients to multiple-screen immersive TelePresence endpoints, an organization can deploy the right variety of endpoints to meet users' needs (Figure 4). Additionally, these devices enable users to access multiple communication services such as:

- Voice calls
- Video calls
- Conferencing
- Presence
- Desktop sharing

**Figure 4** Architecture for Endpoints

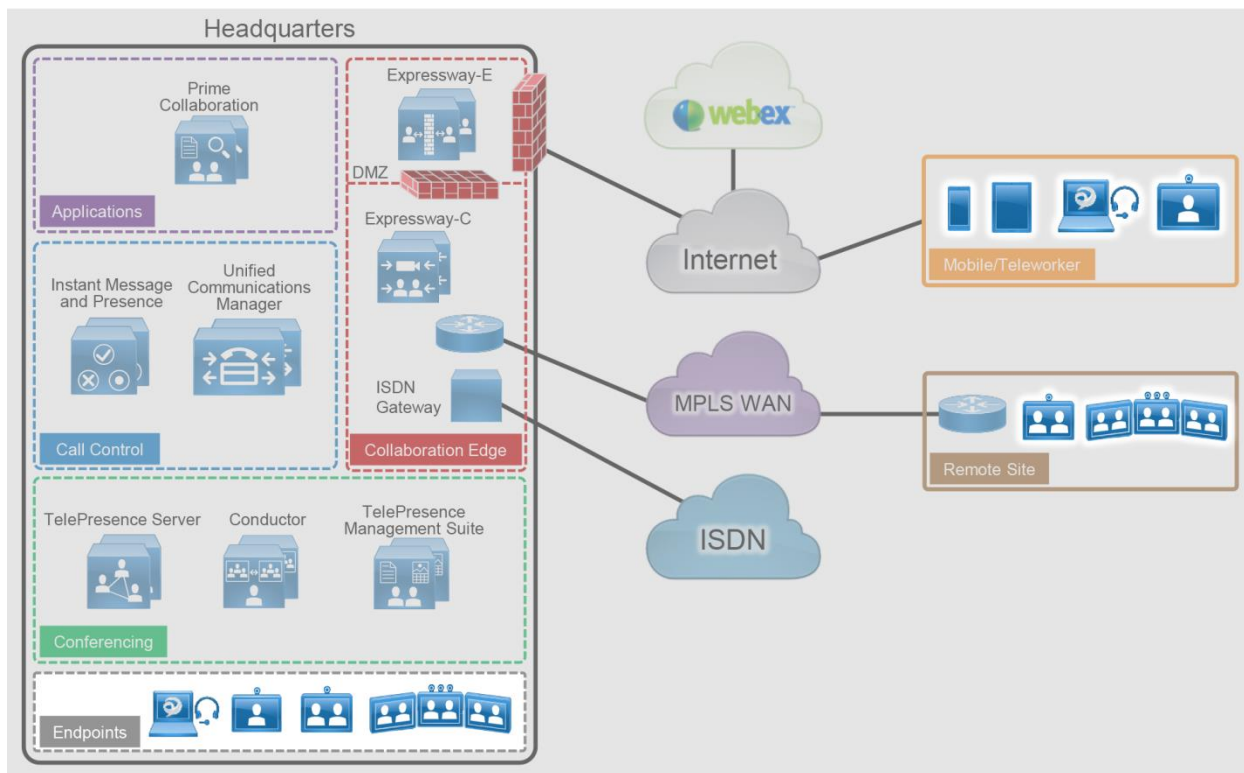

## Recommended Deployment

Cisco Unified CM is the call control server for the Cisco PA for Video. Use SIP to register Cisco Jabber clients and video endpoints directly to Cisco Unified CM. The Unified CM cluster's failover mechanism provides endpoint registration redundancy.

We recommend the endpoints listed in following tables because they provide optimal features for this design at an attractive price point. Cisco has a [range of endpoints](#) with various features and functionality that an organization can also use to address its business needs.

**Table 2** Cisco TelePresence and Video Endpoints

Product	Description
Cisco DX Series	Collaboration desk endpoint
Cisco MX Series	Collaboration room endpoint
Cisco SX Series	TelePresence integration solutions
Cisco IX Series	Immersive TelePresence room system
Cisco IP Phones 8845 and 8865	General office phones (video)

**Table 3** Cisco Jabber

Product	Description
<b>Mobile:</b> Jabber for Android Jabber for iPhone and iPad	Soft client with integrated voice, video, voicemail, and instant messaging and presence functionality for mobile devices and personal computers
<b>Desktop:</b> Jabber for Mac Jabber for Windows	

**Table 4** Comparison of Endpoint Features and Capabilities

Product(s)	Audio	Video	Content Sharing	Unified CM High Availability	Mobile and Remote Access
Jabber Mobile	Y	Y	N	Y	Y
Jabber Desktop	Y	Y	Y	Y	Y
DX Series <sup>2</sup>	Y	Y	Y <sup>1</sup>	Y	Y
MX Series	Y	Y	Y	Y	Y
SX Series	Y	Y	Y	Y	Y
IX Series	Y	Y	Y	Y	N
Cisco IP Phones 8845 and 8865	Y	Y	N	Y	Y

1. The Cisco DX70 and DX80 are the only DX Series endpoints that support content sharing.
2. Cisco DX70 and DX80 run CE software.

# Call Control

Call control is the core element for any video deployment. It provides endpoint registration, call processing, and call admission control. Call control design considerations include the dial plan, endpoint addressing schema, calling party presentation, call admission control, codec selection, external connectivity, and general trunking requirements, as well as other factors.

Cisco Unified CM provides a common call control platform for all Cisco Video deployments (Figure 5). Having a highly available and common call control component for a communications infrastructure is crucial to provide consistent services for all devices and communication types and to preserve a uniform dial plan and a consistent feature set across the organization.

Adding the IM and Presence Service to a Cisco Unified CM deployment provides instant messaging, network-based presence, and federation for third-party chat servers, and it enables the use of Cisco Jabber for instant messaging, presence, voice and video communications.

**Figure 5** Architecture for Call Control

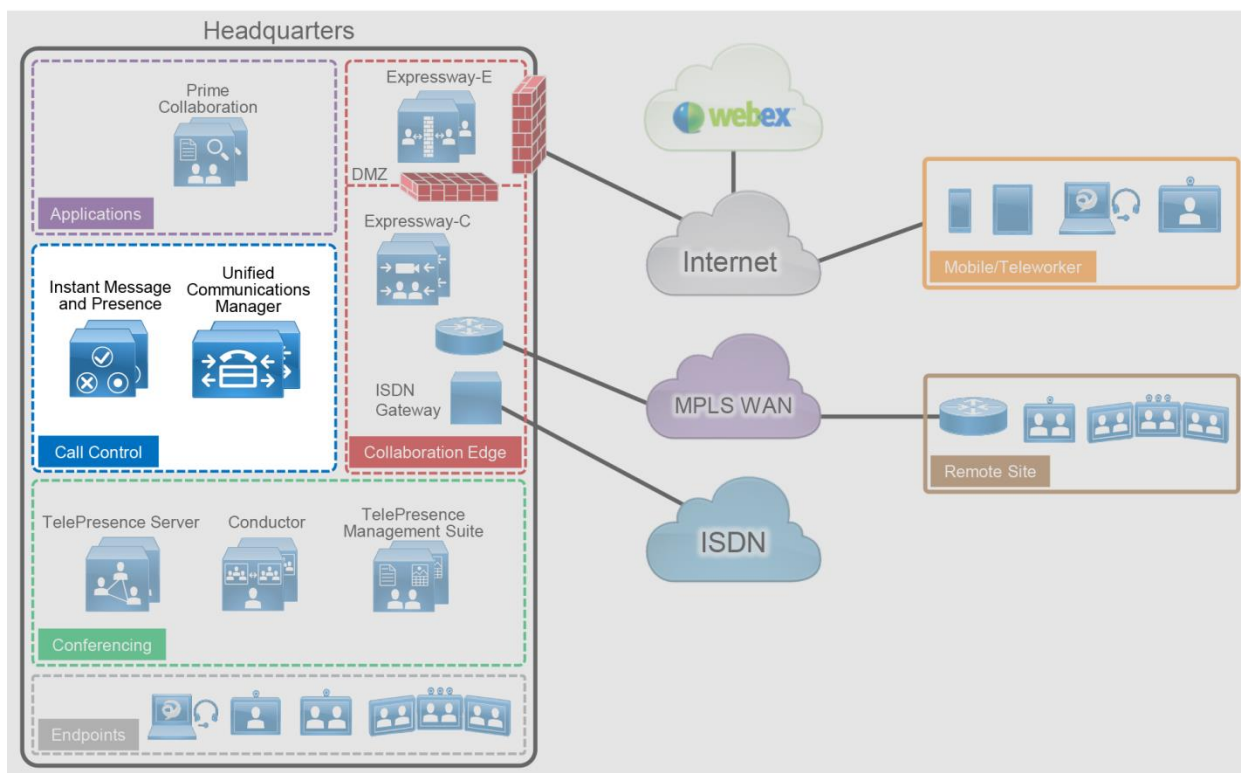

Table 5 lists the roles of the call control components in this architecture and the services they provide.

**Table 5** Components for Call Control

Module	Component	Description
Call Control	Cisco Unified Communications Manager (Unified CM)	Provides call routing and services, dial plan, bandwidth management, and device-based presence, and enables Cisco Jabber desktop endpoint control
	Cisco Unified Communications Manager IM and Presence Service	Provides Cisco Jabber support for instant messaging, presence, and third-party federation

## Recommended Deployment

- Deploy a single Cisco Unified CM cluster for a central site and remote offices. Deploy a call processing subscriber for scalability and redundancy.
- Deploy two IM and Presence Service servers in a cluster configuration that includes a publisher node and a subscriber node for scalability and redundancy.

**Note:** If full redundancy is not required, a single server may be deployed without loss of functionality.

## Benefits

This deployment provides the following benefits:

- Call control is centralized at a single location and serves multiple remote sites.
- Management and administration are centralized.
- Common features are available across all video endpoints.
- Single call control and a unified dial plan are provided for video endpoints.
- Critical business applications are highly available and redundant.

## Deployment Best Practices

### Cisco Unified Communications Manager and IM and Presence Service

#### *Cluster Recommendations*

Cisco Unified CM and IM and Presence support clustering, which is the grouping of nodes that work together as a single logical entity ([Figure 6](#)). The publisher node contains the cluster's configuration database, which is replicated to the subscriber node.

Clustering provides an automatic redundancy mechanism for endpoints and for Cisco Unified CM services, such as the ability to receive and process incoming calls. The subscriber node periodically receives a copy of the configuration database from the publisher node. This database replication ensures that all nodes operate in a consistent configuration state.

For IM and Presence, we recommend deploying an IM and Presence publisher and subscriber node. The publisher and subscriber provide redundancy for each other.

Figure 6 Cisco Unified CM Cluster

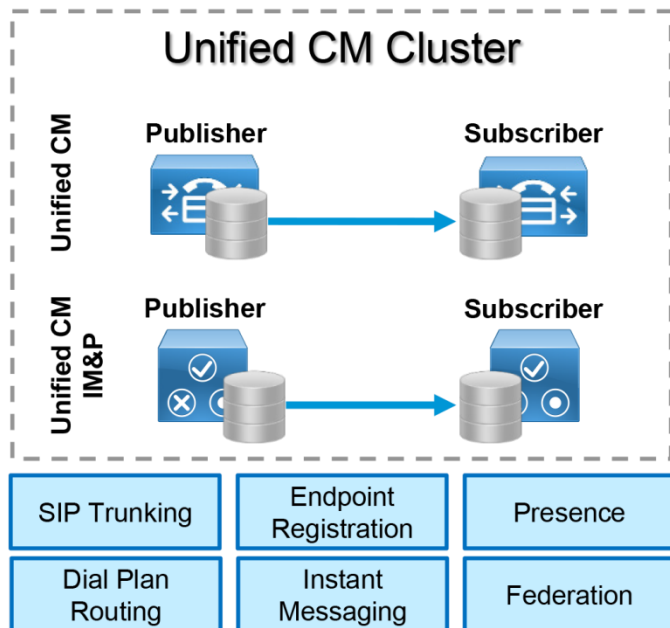

### SIP Trunk Recommendations

Use SIP trunks from Cisco Unified CM to communicate with all the components in the Cisco PA for Video, including external entities such as third-party systems. SIP trunks offer the following benefits:

- SIP trunks provide a standards-based environment that reduces operations and maintenance complexity of the end-to-end solution.
- SIP trunks are enhanced with presence information.
- SIP trunks are recommended for video communications

### Dial Plan

A structured, well-designed dial plan is essential to successful deployment of any call control system. When designing a dial plan, consider the following main factors:

- Dialing habits
- Endpoint addressing
- Routing
- Directory integration
- Classes of service

### Dialing Habits

Dialing habits describe what end users can dial to reach various types of destinations. Dialing habits can first be classified as numeric dialing (for example, 914085550123) or alphanumeric dialing (for example, bob@company.com).

Typically, different types of destinations require support for different dialing habits. For example:

- PSTN toll call: for example, in North America, 91-<10 digits>
- PSTN international call: for example, in North America, 9011-<country code + national significant number>
- Abbreviated intra-site dialing: for example, 4XXX
- Abbreviated inter-site dialing: for example, 8-<site code>-<intra-site number>, 85556XXX



- +-dialing from directories: “+” followed by a fully qualified global PSTN number as described in ITU recommendation E.164
- URI dialing: for example, bob@company.com for intra-company and inter-company dialing. Endpoints typically allow omission of the right-hand side (host portion) of the URI and automatically appending the local host portion, so that bob@company.com can also be abbreviated as bob.

Further dialing habits might have to be defined for services such as call pick-up, recording, and others. Also, future growth should be considered so that more users and more sites can be added as needed without redesigning the dial plan.

Some dialing habits, typically PSTN dialing habits in particular, need to follow country-specific requirements or established dialing procedures. For example, in contrast to the trunk access code 9 in the above US-based examples, 0 is used for trunk access in many other countries. The dialing habit for national calls in these cases, in addition to the potential for using 0 as the trunk access code, also needs to reflect the characteristics of the national numbering plan of the respective country.

Identifying dialing habits is most important when defining a dial plan, in order to avoid overlaps between any two dialing habits. For example, a trunk access code of 9 prohibits abbreviated intra-site dialing starting with 9. Avoiding overlaps between dialing habits is crucial to avoid inter-digit timeouts, which lead to bad user experiences.

In migration scenarios, the dialing habits supported by the existing system can be used as a first estimate of the dialing habits required in the new system. On the other hand, migration to a new communications system can also serve as a reason to get rid of outdated customs and practices.

### ***Endpoint Addressing***

Each endpoint registered with the video call control must have a unique numeric address. Endpoint addresses in Cisco Unified CM are equivalent to the directory numbers provisioned on the lines of the endpoints. Use fully qualified PSTN numbers (E.164 numbers) with a leading “+” as endpoint addresses. This format is typically referred to as +E.164 format. The benefits of using +E.164 endpoint addresses include:

- Wide use in voice networks
- No need to develop and maintain an enterprise numbering scheme
- Easy creation of correct caller ID presentation for all on-cluster and off-cluster call flows
- Easy implementation of directory lookups

For endpoints without assigned PSTN-based direct inward dial (DID) numbers (no E.164 number representation exists), create company-wide unique endpoint addresses outside of the default +E.164 domain. These endpoint addresses should be in line with the internal dialing habit defined to reach these endpoints. If, for example, the abbreviated inter-site dialing habit to reach a set of non-DID endpoints in a given site is 84915XXX, then these non-DID endpoints should use this numbering scheme for their endpoint addresses.

In addition to the primary numeric endpoint addresses, administrators should provision alphanumeric URIs (for example, bob@company.com) in Cisco Unified CM to serve as aliases for the primary addresses, and users can enter the URI as an alternate way to dial the destination endpoint. Every connected and registered video endpoint should be assigned both a numeric address and an alphanumeric alias so that the organization’s users can dial either address to reach the video endpoint.

### ***Routing***

The routing portion of the dial plan enables users to reach the correct destinations when they use the defined dialing habits.

The primary numeric routing is based on +E.164 numbers. External routes to other transport networks such as the PSTN also use the +E.164 scheme. All other numeric dialing habits, such as abbreviated inter-site and intra-site dialing, are implemented as overlays by adding the appropriate translation patterns to the dial plan to map from the implemented dialing habit to the +E.164 global routing address format. This allows users to reach the same endpoint by means of different dialing habits, depending on user preference.

Alpha-numeric URIs, as aliases for numeric addresses, provide an alternative means of reaching endpoints. The benefits of URI dialing and routing include:

- Conformity with the native dialing habit on most video systems
- Easier business-to-business connectivity
- Direct mapping from instant messaging identifiers to addresses (easier escalation of business-to-business IM sessions to voice and/or video), although technically IM identifiers and SIP URIs are not necessarily identical

As with numeric routing, if an alias or SIP URI is recognized as an internal destination and is associated with a specific device, then Cisco Unified CM sends the call to that device. However, if the dialed SIP URI does not match any registered endpoint alias, Cisco Unified CM uses SIP route patterns to determine where to send the call. For example, if the dialed alias `room1@example.com` does not exist internally, Cisco Unified CM uses a SIP route pattern (such as `*.com`) to send the call to Expressway-C as a business-to-business call.

### **Directory Integration**

To enable users to search contacts and dial from the directory, integrate Cisco Unified CM with the organization's LDAP directory. Although Cisco Unified CM allows the creation of local user contacts, LDAP directory integration is recommended when using Cisco Jabber because it provides a single location for directory management and enables users to authenticate to Cisco Unified CM and Cisco Jabber by using their LDAP directory credentials.

In addition to using LDAP for user authentication, Cisco Unified CM pulls user information from LDAP directories and synchronizes user parameters – name, surname, username, telephone number, and SIP URI – when changes occur. For example, use the **telephoneNumber** attribute to populate the Telephone Number field in the Cisco Unified CM directory. The format of phone numbers in the corporate directory must be globally significant and must match one of the defined dialing habits. Corporate directories typically should have all phone numbers in +E.164 format (leading “+” followed by the fully qualified global number) as long as a DID exists. Only this format allows the phone number in the corporate directory to be used universally inside and outside the organization. Non-DID numbers that are not in +E.164 format could be used to dial users internally from the directory, but they would have no significance outside the organization. Use the **mail** attribute to populate the Directory URI field in the Cisco Unified CM directory for URI dialing.

The IM and Presence Service pulls user and contact information from Cisco Unified CM.

### **Class of Service**

Classes of service define which users can access which services, such as allowing only emergency and local calls from lobby phones while allowing unrestricted calls from executive phones. The complexity of the dial plan is directly related to the number of differentiated classes of service it supports.

To define classes of service, configure partitions and calling search spaces in Cisco Unified CM. The number of classes of service supported by a dial plan depends on the granularity and complexity of the classes. For more information about classes of service and details on dial plan design, see the [Cisco Collaboration SRND](#).

### **Admission Control**

Call admission control (CAC) mitigates congestion on WAN links due to excessive voice and video traffic. In cases where the administrator needs to control how many media calls flow over various links in the WAN topology, Cisco Unified CM Enhanced Location Call Admission Control (ELCAC) provides a solution. ELCAC supports various WAN topologies and gives the administrator the ability to statically model the WAN network topology to support admission control for voice and video calls.

Cisco Unified CM uses locations and links to model how the WAN network topology routes media between groups of endpoints within a location for voice and video conference calls. [Figure 7](#) illustrates locations, links, and voice and video bandwidth pools for modeling the WAN topology and creating separate voice and video bandwidth allocation pools. Voice allocations are for voice-only calls, while video allocations are for both the voice and video portions of a video call.

**Figure 7** Call Admission Control Locations, Links, and Bandwidth Pools

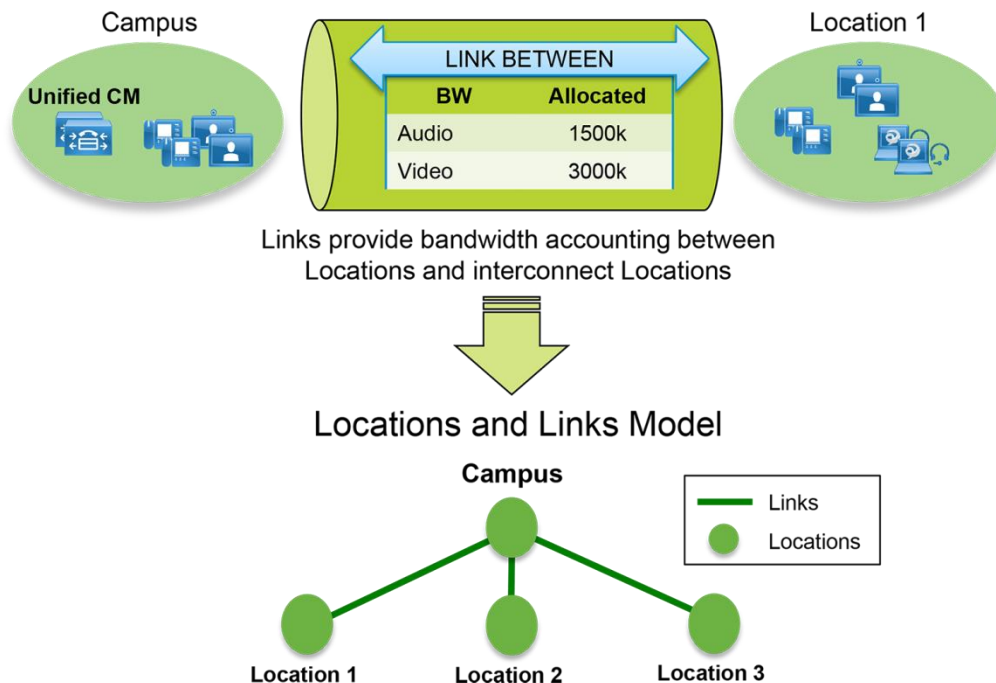

### Multi-Cluster Deployment Considerations

Consider deploying more than one Cisco Unified CM cluster if you have any of the following concerns:

- **Administrational separation**

This includes the need to keep users from different parts of the organization on separate infrastructures, or the requirement to have different departments operate different parts of the communications infrastructure.

- **Geographic footprint**

Technical limitations such as excessive propagation delay might prohibit endpoint registrations (for example, endpoints in Asia registering to an enterprise call control hosted in the US).

In a multi-cluster deployment, interconnect all the individual Unified CM clusters through SIP trunks. To avoid session traversal through individual clusters, deploy a full mesh of SIP trunks. With four or more clusters, deploy Cisco Unified CM Session Management Edition to centralize the dial plan and trunking and to avoid the complexity of a full-mesh SIP trunk topology.

In multi-cluster deployments, use Global Dial Plan Replication (GDPR) to replicate dial plan information between clusters. GDPR can advertise a +E.164 number, one enterprise significant number (ESN), and up to five alpha-numeric URIs per directory number. An ESN is the abbreviated inter-site dialing equivalent of a directory number. The information advertised and learned through GDPR enables deterministic inter-cluster routing for these dialing habits:

- +E.164 dialing based on the advertised +E.164 numbers
- Enterprise abbreviated inter-site dialing based on the advertised ESNs
- Alphanumeric URI dialing based on the advertised URIs

Unified CM Enhanced Location CAC network modeling supports multi-cluster distributed Unified CM deployments. This allows the administrator to "share" locations between clusters by enabling the clusters to communicate with one another to reserve, release, and adjust allocated bandwidth for the same locations across clusters. This is a feature called intercluster call admission control.

# Conferencing

The ability for three or more people to communicate in real time by using video technology is a core component of any video deployment. Cisco rich media conferencing builds upon existing infrastructure in place for point-to-point calls, offering users a consistent video experience regardless of how many participants are involved (Figure 8).

**Figure 8** Architecture for Conferencing

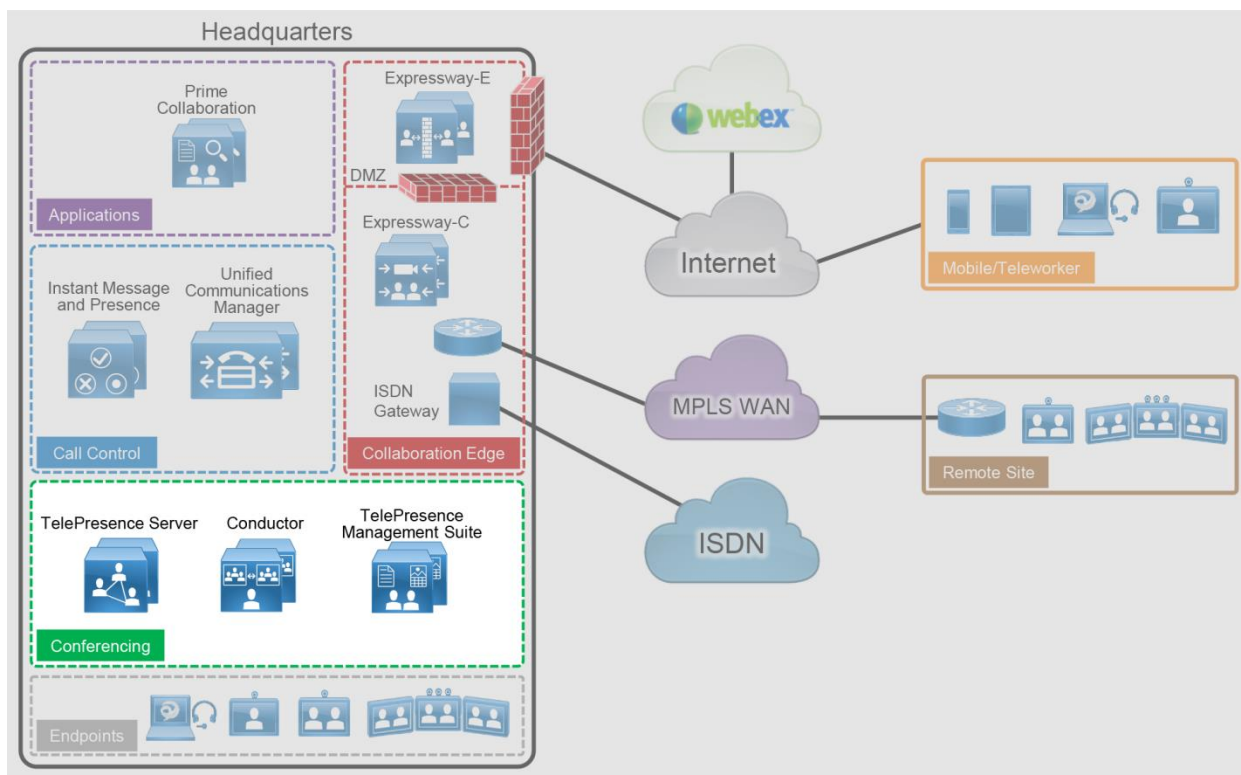

Table 6 lists the roles of the conferencing components in this architecture and the services they provide.

**Table 6** Components for Conferencing

Module	Component	Description
Conferencing	Cisco TelePresence Conductor	Manages and allocates conferencing resources requested from Unified CM. Optimizes resources by making unused resources available for greater scale in conferencing.
	Cisco TelePresence Server	Provides voice and video conferencing. Available on dedicated hardware platforms and on virtual machine. Can be deployed with Cisco TelePresence Conductor (remotely managed mode) or as a standalone conference resource (locally managed mode).
	Cisco TelePresence Management Suite and Extensions	Provides conference scheduling and monitoring, and device management capabilities. Integrates with calendar system to schedule meetings.
	Cisco WebEx Software as a Service (SaaS)	Subscription-based web conferencing delivered through WebEx Collaboration Cloud.

There are three types of conferences:

- **Instant or ad hoc** — A conference that is not scheduled or organized in advance. For example, a call between two parties who add additional parties to the call, is an instant conference.
- **Permanent or rendezvous** — A conference that requires callers to dial a predetermined number or URI to reach a shared conferencing resource. Meet-me and static are other names for this type of conference.
- **Scheduled** — A conference planned in advance with a predetermined start time. Typically, conference resources are guaranteed to be available upon the start of the scheduled conference.

## Recommended Deployment

- Deploy Cisco TelePresence Server on Multiparty Media 410v (MM410v) in remotely managed mode for all conference types.
  - Deploy Cisco TelePresence Conductors in a cluster with TelePresence Servers as managed conference bridges.
  - Integrate the TelePresence Conductor cluster with Cisco Unified CM through SIP trunks and registered media resource conference bridges for instant conferences.
  - Integrate the TelePresence Conductor cluster with Unified CM through SIP trunks and route patterns for permanent and scheduled conferences.
  - Deploy Cisco TelePresence Management Suite to schedule conferences with TelePresence Conductor. Deploy Cisco TelePresence Management Suite Provisioning Extension for provisioning of personal collaboration meeting rooms (CMRs).
- Deploy Cisco WebEx Software as a Service (SaaS) for scheduled web conferences. If customers have special requirements that forbid storage of any data outside the company, Cisco WebEx Meetings Server can be deployed on-premises for scheduled web conferences.
- Integrate Cisco WebEx conferencing with on-premises voice and video conferencing through the Cisco CMR Hybrid solution.
- As an alternative, an entirely cloud-based conferencing solution is available for customers concerned with keeping capital expenditure costs low.

**Note:** Cisco TelePresence Management Suite supports two nodes for TelePresence Conductor failover. If full redundancy of the other applications is not required, a single server may be deployed without loss of functionality.

## Benefits

This deployment provides the following benefits:

- Users have a consistent experience for launching and joining various types of conferences.
- A single conferencing platform provides on-premises rich media conferencing, allowing both audio and video users to connect to the same resource and receive the best quality available to them.
- Cisco CMR Hybrid allows users to connect to meetings either from their video and voice devices or through the WebEx Cloud with a meeting client running on their desktop or mobile devices.
- It provides real-time, high-definition video conferencing, including the ability to share content easily over a dedicated presentation channel.

## Deployment Best Practices

### Instant Video Conferencing

For instant video conferences, use on-premises MultiParty Media 410v TelePresence Servers managed by TelePresence Conductor as media resources. TelePresence Conductor conference templates are referenced by multiple virtual IP addresses. These TelePresence Conductor virtual IP addresses register with Cisco Unified CM as instant conference bridges and are used in media resource group lists (MRGLs) and media resource groups (MRGs). Unified CM uses MRGLs and MRGs to prioritize and allocate media resources such as conference bridges, music on hold sources, announciators, transcoders, and media termination points (MTPs).

If endpoints have access to the appropriate MRGL, they can request these resources. Resources local to the initiating endpoint are preferred over remote resources ([Figure 9](#)).

**Figure 9** Media Resource Group List (MRGL) Example

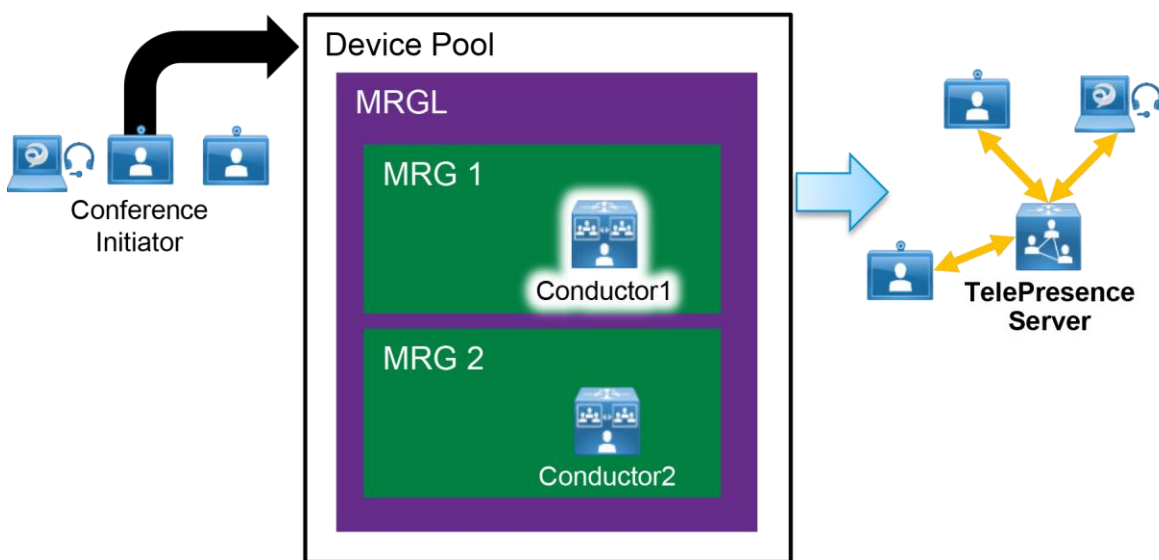

A single TelePresence Conductor cluster can have multiple conference templates configured to provide a variety of service levels and experiences for instant video conferences. With this architecture, administrators can segment their users and provide restrictions on instant conference size, media properties, and additional features such as content sharing.

### Permanent Conferences with Cisco Collaboration Meeting Rooms (CMR) Premises

Permanent conferences are deployed using Cisco Collaboration Meeting Rooms (CMR) Premises. Cisco CMR Premises provides a permanent-type conference that is created with Cisco TMSPE in conjunction with the Conductor Provisioning API that simplifies the deployment of on-premises audio and video conferencing. Administrators should use CMR Premises to quickly configure and provision conferences, providing each user with their own personal conference space. Users browse to a website with a simple interface and create their conference, specifying preferences such as welcome screen text, participant layout, and conference PIN protection.

Cisco TelePresence Management Suite Provisioning Extension (TMSPE) enables rapid provisioning of TelePresence users and their respective personal CMRs for large-scale deployments. TMSPE runs on the same Windows Server as the TMS application.



Administrators must create a CMR template in TMS to specify the base dial plan for CMR URIs and numeric aliases. When users create and personalize their CMRs, they receive instructions for how to dial in to their meetings, and these numbers and URIs are in line with the CMR template configured in TMS. As users create their CMRs, TMSPE provisions and configures the necessary settings on TelePresence Conductor, and no further interaction is needed from an administrator.

#### ***Cisco WebEx Software as a Service***

Cisco WebEx SaaS is a subscription-based service delivered through the WebEx Collaboration Cloud, where all the meetings are hosted. Few components are deployed on-premises, so this option is well suited for customers who manage their communications budget as an operational expenditure.

WebEx Collaboration Cloud is highly available and has redundancy built into the infrastructure to handle component failure. Deploy Cisco WebEx SaaS using WebEx audio for web conferencing. We highly recommend enabling HD video for the optimal video experience and enabling Single Sign-On (SSO) to allow integration with the organization's LDAP directory for access using common credentials.

For additional information on Cisco WebEx Software as a Service, see the [product documentation](#).

#### ***Cisco WebEx Meetings Server***

Cisco WebEx Meetings Server is a secure, fully virtualized WebEx conferencing solution with all of its equipment deployed on-premises behind the firewall. This option works well for customers that have strict requirements forbidding storage of any data outside the company.

Cisco WebEx Meetings Server builds on top of the Cisco Collaboration infrastructure and extends the implementation of Cisco Unified CM to include conferencing. Connect Cisco WebEx Meetings Server and Cisco Unified CM by means of SIP trunks to provide services for attendees dialing into the system and for system callback to attendees to join the meetings.

Deploy Cisco WebEx Meetings Server with redundancy to provide system availability in the event of component failures. With high availability, the system uses the N+1 redundancy scheme and runs in active/active mode. In addition, we recommend enabling high-quality (HQ) video for the optimal video experience and integrating WebEx Meeting Server with the organization's LDAP directory so that users can use the same credentials to access the meeting scheduler.

For additional information on Cisco WebEx Meetings Server, see the [product documentation](#).

### Scheduled Video Conferences

For scheduled video conferences, use the same Cisco TelePresence Conductor for non-scheduled conferences with remotely managed Cisco TelePresence Servers as the conferencing resource. The TelePresence Server resource can be shared between both scheduled and non-scheduled conferences, or a second Multiparty Media 410v TelePresence Server can be dedicated for scheduled conferences only (Figure 10). Integrate the TelePresence Conductor to Cisco Unified CM with SIP trunks, and manage it through Cisco TMS.

Figure 10 Architecture for Video Conferencing

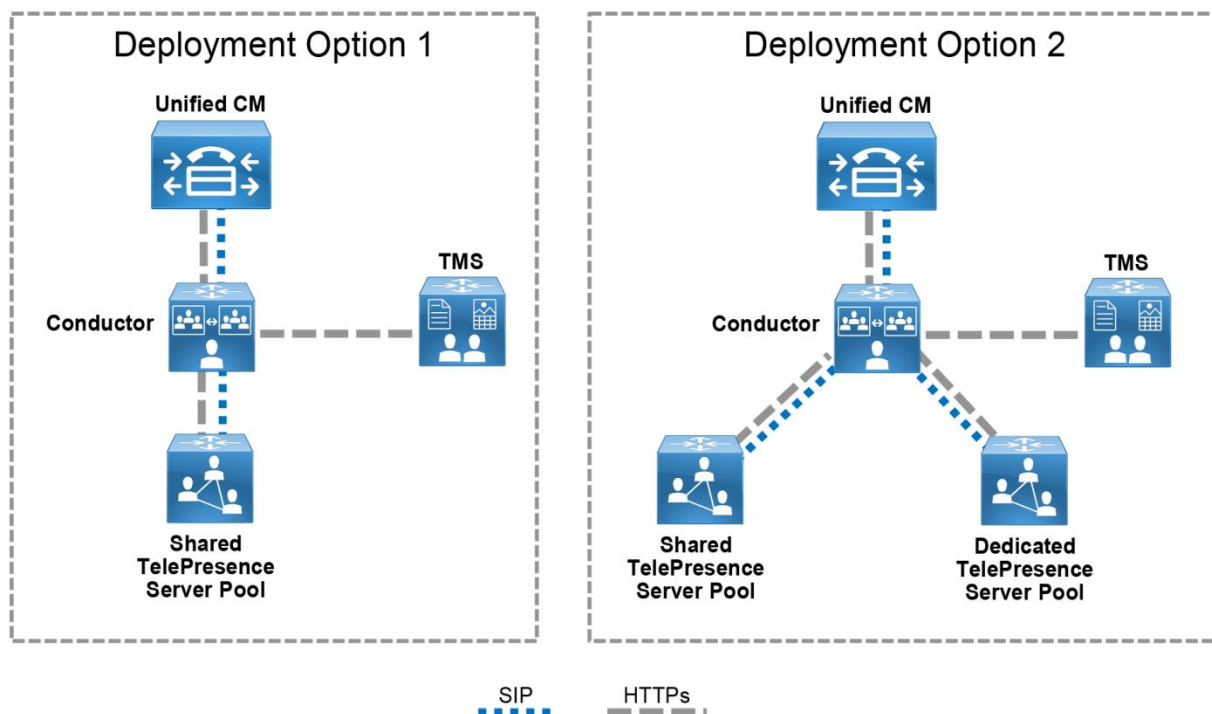

### Collaboration Meeting Rooms Hybrid (CMR Hybrid)

Cisco CMR Hybrid combines scheduled on-premises video conferencing with WebEx Cloud-based conferencing into a single meeting. Participants can join the scheduled meeting using the WebEx meeting client or a video endpoint, and they experience two-way video, audio, and content sharing from their respective devices. As illustrated in Figure 11, we recommend deploying Cisco Expressway-C and Expressway-E to handle calls to and from the WebEx Cloud, and Cisco Expressway Rich Media Session Licenses are required. Deploy a Cisco TelePresence Conductor with remotely managed Cisco TelePresence Server as the TelePresence conference resource. Configure all TelePresence devices to register to Unified CM.

As with other components in this architecture, deploy Cisco Unified CM, Cisco TelePresence Conductor, and Cisco Expressway in cluster configurations to provide redundancy in case of a failure event.

Figure 11 Architecture for CMR Hybrid

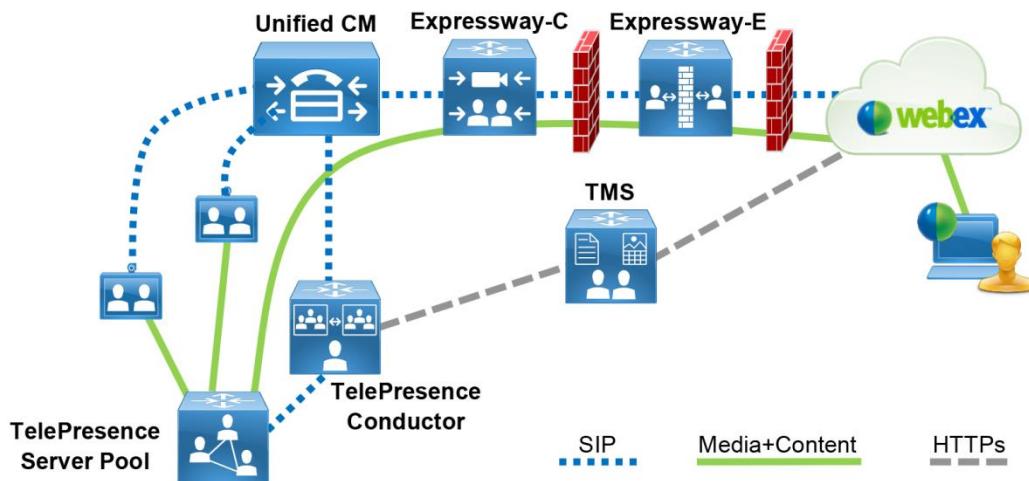

### Collaboration Meeting Rooms Cloud (CMR Cloud)

Cisco CMR Cloud is an alternate conferencing deployment model that negates the need for any on-premises conferencing resource or management infrastructure. CMR Cloud is a simple-to-use cloud hosted meeting room solution that is offered as an add-on option to a Cisco WebEx Meeting Center subscription, and it is delivered through the Cisco WebEx Cloud. CMR Cloud negates the need for on-premises conferencing resources but still requires deployment of local call control, as illustrated in Figure 12. The solution enables meetings in the cloud that can scale to support up to 25 standards-based video endpoints and up to 500 video-enabled WebEx Meeting Center users in a single meeting. Participants can join CMR Cloud conferences from Cisco TelePresence endpoints, third-party standards-based video endpoints and unified communications clients, soft clients such as Cisco Jabber, and Cisco WebEx enabled mobile or desktop web clients. CMR Cloud is recommended as an alternative to on-premises conferencing equipment for customers interested in keeping capital expenses low, or those who already utilize Cisco WebEx Meeting Center and are looking to expand their video capabilities.

Figure 12 Architecture for CMR Cloud

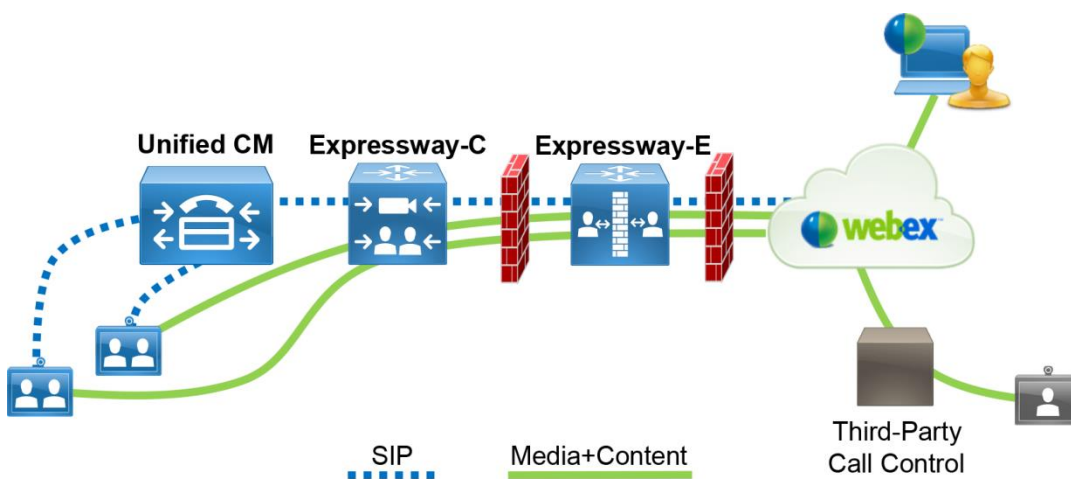

## Support for Multiple Call Processing Sites

Organizations may choose to implement multiple TelePresence Servers and more than one Cisco TelePresence Conductor cluster for any of the following reasons:

- **Administrational separation** — This includes the need to keep users from different parts of the organization on separate infrastructures or to have different departments operate different parts of the communications infrastructure.
- **Geographic footprint** — Physical limitations such as excessive latency between endpoints and conferencing resources could degrade the user experience. (For example, US users might not have a productive collaborative meeting if they use conferencing resources located in Europe.)
- **Multiple Unified CM clusters** — If more than one Unified CM cluster is already deployed for the previously mentioned reasons, we recommend also deploying multiple TelePresence Conductor clusters to ensure that conference services are preserved in the event of a WAN failure. These multiple TelePresence Conductor clusters can be used for resiliency as well, in case a local TelePresence Conductor cluster temporarily goes down.

Deploy multiple TelePresence Conductor clusters along with local TelePresence Server resources (Figure 13). Implement a global dial plan, as discussed in the [Call Control](#) section, to enable users to access conferences regardless of where the TelePresence Conductor or TelePresence Server is located.

**Figure 13** Multiple Call Processing Sites with Conferencing

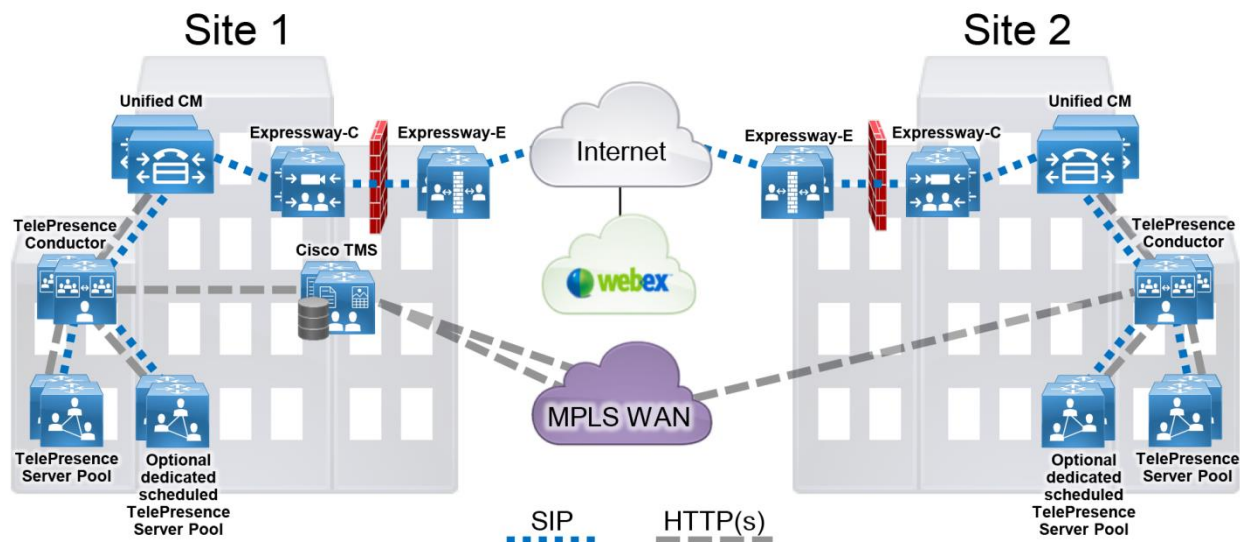

## Cisco TelePresence Management Suite and Extensions

Cisco TelePresence Management Suite (TMS) runs on a Windows Server instance and provides the scheduling and call initiation functions for the organization. User profiles are imported from Active Directory, and the permissions model allows for access control to different components and configured systems. The TMS application also provides users with enhanced features such as directories and one button to push (OBTP) on controlled endpoints. TMS utilizes a Microsoft SQL database for all information about users, controlled devices, and scheduled conferences. In addition to the core TMS application, the following two additional software extension applications provide supplemental features and services to enhance the overall video communications experience:

- Cisco TelePresence Management Suite Provisioning Extension (TMSPE)

TMSPE provides the functionality to create collaboration meeting rooms (CMRs) for users according to the permissions and feature limits defined by the administrator. In addition to the CMR functionality, TMSPE also engages other scheduling options, besides the administrator booking page, within the TMS application. One of these options includes the ability to schedule CMR Hybrid, bringing WebEx functionality and scale to meetings.
- Cisco TelePresence Management Suite Extension for Microsoft Exchange (TMSXE)

TMSXE allows end users to schedule meetings by using their Microsoft Outlook clients and to include the room system video resources by selecting the room as a resource.

### Recommended Deployment

Deploy a single instance of TMS for the organization, and leverage the integrated system navigator folder structure to organize all endpoints and infrastructure devices. Even multinational and global organizations can benefit from a single instance of TMS to facilitate video connections.

For Cisco BE6000 deployments, TMS and all of its supporting components can be installed on a single Windows server instance. This is called a TMS Regular Deployment and is subject to the following constraints:

- TMS Solution — TelePresence Management Suite (TMS), TelePresence Management Suite Provisioning Extension (TMSPE), and TelePresence Management Suite Extension for Microsoft Exchange (TMSXE) all reside on a single virtual machine
- TMS
  - Maximum of 200 controlled systems
  - Maximum of 100 concurrent participants
  - Maximum of 50 concurrent ongoing scheduled conferences
- TMSXE
  - Up to 50 endpoints bookable in Microsoft Exchange
- TMSPE
  - Up to 1000 Collaboration Meeting Rooms

For larger deployments, TMSXE must be installed separately. See the [Cisco TelePresence Management Suite Installation and Upgrade Guide](#) for details on larger deployments.

### *Redundancy Model for TMS and TMSPE*

Redundancy of TMS and TMSPE is different from other components in the Preferred Architecture. TMS and TMSPE operate in an active/passive node model instead of clustering. A single instance of TMS consists of a network load balancer, two servers hosting TMS and TMSPE applications, and the SQL database. The licensing for the instance is maintained in the SQL database, so separate licensing is not required for each node. Only one server for each application will be active at any moment, with the web pages and services of the passive (inactive) node locked down, and it will refuse all other incoming traffic. All servers must be members of the same domain.

Deploy the Microsoft SQL database on a separate server from the TMS application server. The instance of SQL may be shared by other applications within the organization. The server hosting these SQL databases must be configured with the same time zone and NTP source as the TMS application servers

For the redundancy design to work effectively, a network load balancer (NLB) must be deployed in front of the TMS/TMSPE application server, as shown in [Figure 14](#). The virtual IP address (VIP) of the NLB is what is given to endpoints and applications for accessing TMS, including the DNS records for the TMS web traffic. Each application server has the key services write a small keep-alive time stamp in the SQL database. Those time stamps are what trigger a failover event. In addition to the writing to the database, there is direct server-to-server communications between nodes using HTTPS and direct file sharing (DFS) for the Windows operating system files needed by the application. This API connection between the two servers can also trigger a failover event.

Cisco TelePresence Management Suite Extension for Microsoft Exchange does not support redundancy in this deployment because it resides on the Cisco TMS server.

**Figure 14** TMS and TMSPE Redundancy Model

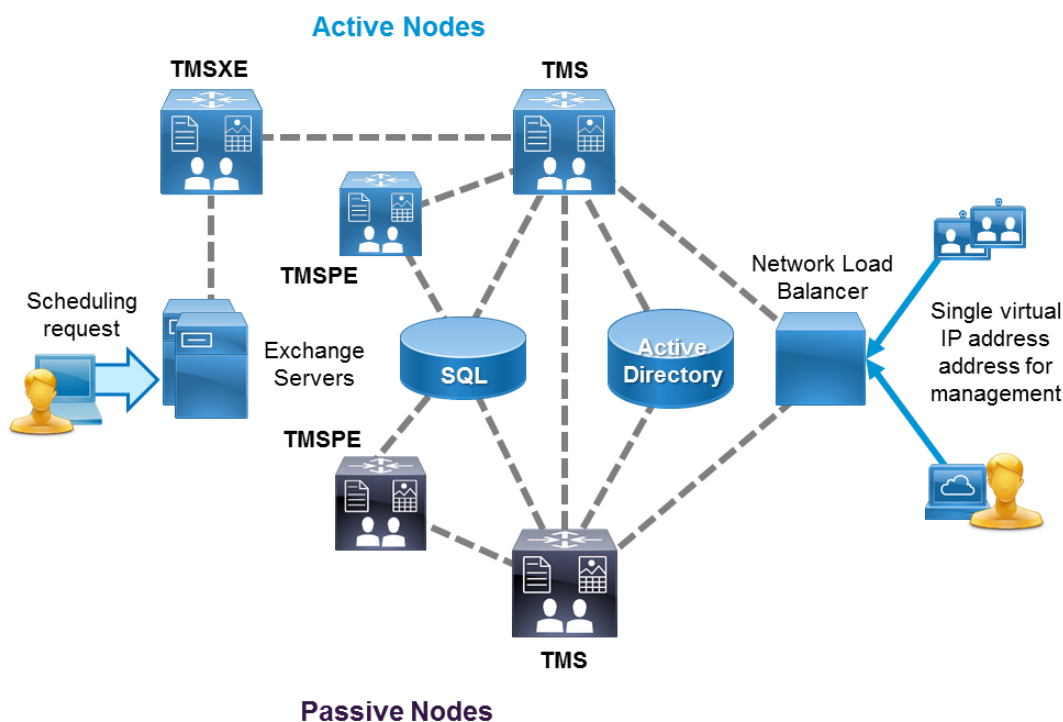

**Benefits**

- A properly configured and deployed TMS instance with the software extensions provides end users with a user-friendly and feature-rich experience.
- Users can schedule conferences for video, audio, and Web participants through a single unified interface. In addition, participants can launch the conference session with one button to push (OBTP) on supported endpoint devices.
- Even multinational and global organizations can benefit from a single instance of TMS for facilitating video connections.



# Collaboration Edge

Business demand for video connectivity between organizations by leveraging the Internet has increased significantly over the past few years. For many organizations, video and content sharing are fundamental requirements for conducting day-to-day activities. Moreover, securely connecting mobile and remote site workers to each other and to headquarters is a critical function that enables organizations to accomplish their business goals. The Cisco PA for Video addresses these needs with the Collaboration Edge architecture in [Figure 15](#).

**Figure 15** Architecture for Collaboration Edge

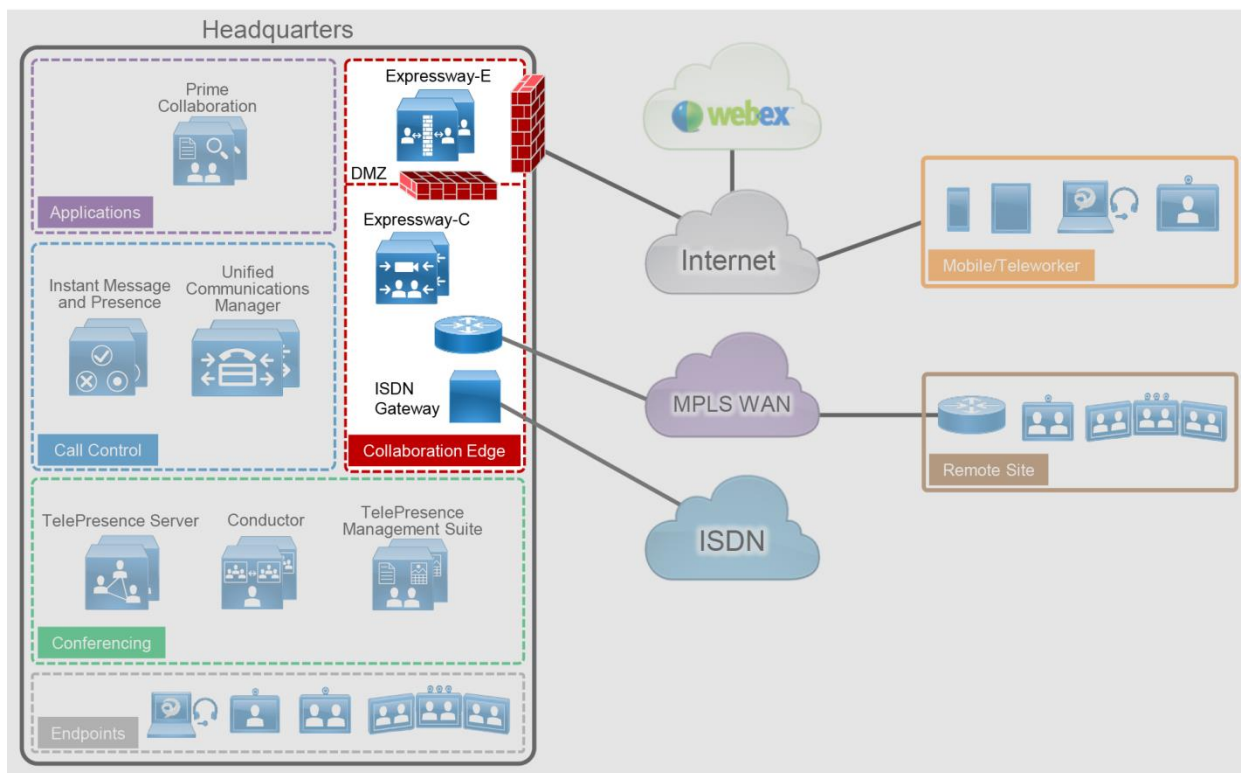

[Table 7](#) lists the roles of the Collaboration Edge components in this architecture and the services they provide.

**Table 7** Components for Collaboration Edge

Module	Component	Description
Collaboration Edge	Cisco Expressway-E	The traversal server that enables secure mobile and remote access for TelePresence endpoints and Jabber clients without a virtual private network (VPN). The Expressway-E resides in the DMZ. The solution also provides business-to-business calling, protocol interworking, and cloud connectivity.
	Cisco Expressway-C	The traversal client that creates a secure, trusted connection through the firewall to Expressway-E. The Expressway-C resides inside the organization's network. The solution provides mobile and remote access, business-to-business calling, protocol interworking, and cloud connectivity.
	Cisco Telepresence ISDN Gateway	Enables interoperability with H.320 video endpoints

## Recommended Deployment

- Deploy two Cisco Expressway-C and two Expressway-E servers in a clustered configuration to enable remote Jabber and video endpoint registrations, and secure business-to-business connectivity through the firewall.
- Deploy video gateways if ISDN interoperability is needed.
- If full redundancy is not required, a single server pair (Expressway-C and Expressway-E) may be deployed.
- Deploy Expressway-C and Expressway-E at remote sites if the sites have local Internet connectivity and an Internet business-to-business architecture for video calls is required.

## Benefits

This deployment provides the following benefits:

- Cisco Expressway provides secured calling, presence, instant messaging, and corporate directory services for external Cisco Jabber and video endpoints without the need for client VPN connectivity.
- Cisco Expressway enables video communications between organizations, partners, and vendors over the Internet.
- Clustered servers enable high availability in the event of a hardware or software service failure.

## Deployment Best Practices

### Cisco Expressway

Cisco Expressway provides secure firewall and NAT traversal for mobile Cisco Jabber and TelePresence video endpoints (Figure 16) and secure business-to-business communications (Figure 17). Cisco Expressway consists of two applications: Expressway-C and Expressway-E.

Deploy Cisco Expressway-C inside the network, and deploy Expressway-E in the demilitarized zone (DMZ) by connecting separate network ports on Expressway-E to the organization's network and to the DMZ.

Cisco fully supports a virtualized Expressway-E in the DMZ; however, a dedicated server can be deployed based on the company's security requirements.

**Figure 16** Traversal for Registrations Through Firewall with Expressway-C and Expressway-E (Mobile and Remote Access)

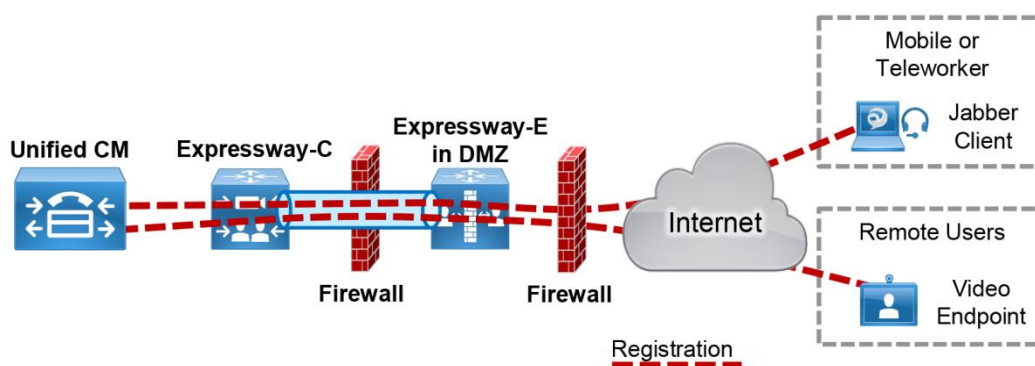

**Figure 17** Traversal for Business-to-Business Calls Through Firewall with Expressway-C and Expressway-E

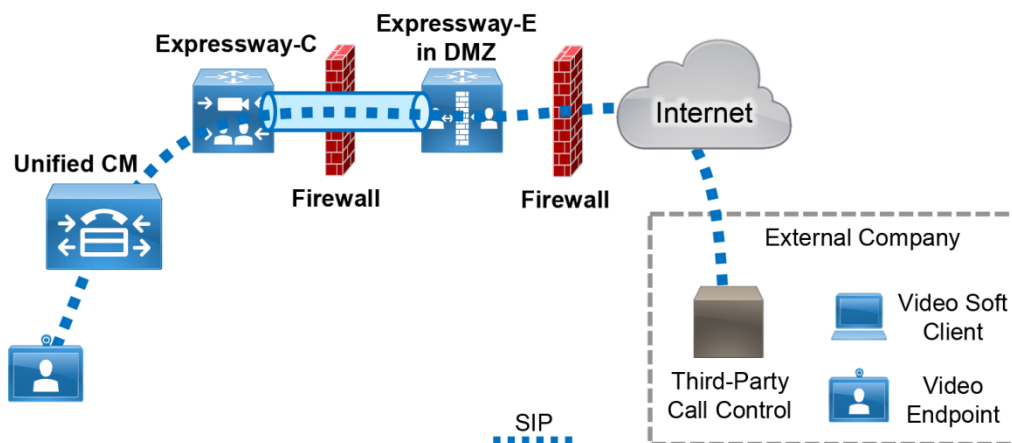

### Cisco Expressway-C

Place Expressway-C in the trusted network inside the organization. Deploy Expressway-C to:

- Function as a traversal client and establish a secure connection to Expressway-E through the firewall.
- Establish connection to Cisco Unified CM.
- Integrate with an existing internal video network that uses H.323.
- Enable business-to-business calls to external entities by providing firewall traversal service on behalf of internal endpoints.
- Enable mobile and remote access capabilities and call signaling for Cisco-supported endpoints, directing them to Cisco Unified CM for SIP registration and/or the IM and Presence Service. (See the [Endpoints](#) section for information on which endpoints support mobile and remote access.)

### Cisco Expressway-E

Because Expressway-E is reachable directly from the untrusted, external network, it should be placed in a DMZ for security. The organization's firewall policies control communications to and from this server. Deploy Expressway-E to:

- Function as a traversal server and allow secure communications to and from Expressway-C.
- Enable voice and video connections to other organizations using SIP or H.323 on the Internet.
- Provide secure communications to cloud-based services, such as CMR Hybrid services to the WebEx Cloud.
- Provide DNS SRV lookup service to resolve outbound calls and to receive inbound calls over the Internet.
- Process registration and IM and presence information from Cisco endpoints on the external network, and use secure traversal communications to pass the information to Expressway-C.
- Provide interworking between protocols (between SIP and H.323, and between IPv4 and IPv6) for business-to-business communications

### Connectivity for Audio and Video over the Internet

Any device on Cisco Unified CM can be reached over the Internet by dialing the assigned alphanumeric SIP URI or the required directory number (DN) by dialing `<+E.164 number>@domain`. For example, a Jabber user might have a SIP URI set to `alice@company.com` and a phone number set to `+14085551234`. If someone dials `alice@company.com` or `+14085551234@company.com` from an external location on the Internet, Alice would receive the call on the Jabber client and all devices that share the same number.

Users on Cisco Unified CM have to dial the full SIP URI to reach a user or device from a different organization over the Internet.

For call routing over the Internet, use public DNS service records. DNS SRV records map a domain to an edge system servicing that domain for that protocol. For example, if a remote user dials alice@company.com, then the remote system uses DNS to query for the host offering the SIP service for the domain company.com.

### **Mobile and Remote Access**

The mobile and remote access feature enables Jabber clients and Cisco DX, EX, MX, SX and C Series endpoints to register securely to Cisco Unified CM through Expressway-E and Expressway-C without a VPN. A Jabber client can send and receive several types of collaboration flows (voice, video, instant messaging, and presence), while a hardware endpoint can send voice and video streams.

The mobile and remote access functionality also leverages Expressway-C and Expressway-E. Both business-to-business and mobile and remote access services are supported on the same server. For large deployments, we recommend deploying these services on different Expressway-C and Expressway-E pairs.

### **ISDN Connectivity for Video**

Although many organizations now use the Internet for business-to-business video connectivity, legacy interoperability with ISDN networks might still be required if the called party is not reachable through the Internet. To provide ISDN connectivity for video, use the following Cisco TelePresence ISDN gateways and connect them to Unified CM with a SIP trunk:

- **Standalone unit** – Cisco TelePresence ISDN GW 3241
- **Chassis mounted unit** – Cisco TelePresence ISDN GW MSE 8321

### **H.323 Endpoints and Connectivity**

The H.323 protocol is still prevalent in video networks, and many organizations continue to use H.323 for call signaling and endpoint registration. Because the Cisco PA for Video is SIP based, SIP-to-H.323 interworking and vice versa might be necessary to provide communications with other video networks. For business-to-business communications, leverage Expressway-E as the SIP-to-H.323 interworking gateway.

For any existing internal H.323 endpoints that are already registered to a third-party gatekeeper, we recommend trunking this gatekeeper to Expressway-C. This allows the Cisco SIP endpoints and any existing H.323 endpoints to communicate. If an existing H.323 gatekeeper is not present, we recommend registering the endpoints to a Cisco Video Communication Server (VCS). We recommend using the VCS to handle the function of SIP-to-H.323 interworking for registered devices only. This allows the interworking to occur when needed but not unnecessarily.

### **Integrating with Microsoft Lync**

Cisco supports audio and video integration with Microsoft Lync 2013 and Microsoft Lync 2010. For environments where customers are using Lync on the desktop for audio and video, deploy a separate Expressway-C as a Lync interop gateway. Expressway-C requires the Microsoft interop key to support standard H.264 AVC to Microsoft SVC interworking, signaling normalization, and signaling and media encryption interworking. Rich media sessions are also required to support the expected number of simultaneous sessions through the gateway.

A separate Expressway-E is required in the event that Lync clients are connecting back into the enterprise through Microsoft Access Edge. The Expressway-E provides TURN services to Lync on behalf of the receiving Cisco endpoints. Cisco Expressway also provides interoperability between Remote Desktop Protocol (RDP) and Binary Floor Control Protocol (BFCP), which allows for two-way content sharing from the Lync side.

**Note:** If Microsoft Lync 2010 is used, the video endpoints registered to Unified CM must support H.263. This is the common video codec supported by endpoints and the Lync client. (The Lync client does not support H.264.)

# Applications

While many additional applications from Cisco and our Ecosystem partners are available, this section focuses on a subset of core applications that are necessary for most collaboration environments. In addition to the call processing and media processing components, the Cisco PA for Video includes Cisco Prime Collaboration for user and device provisioning.

**Figure 18** Architecture for Applications

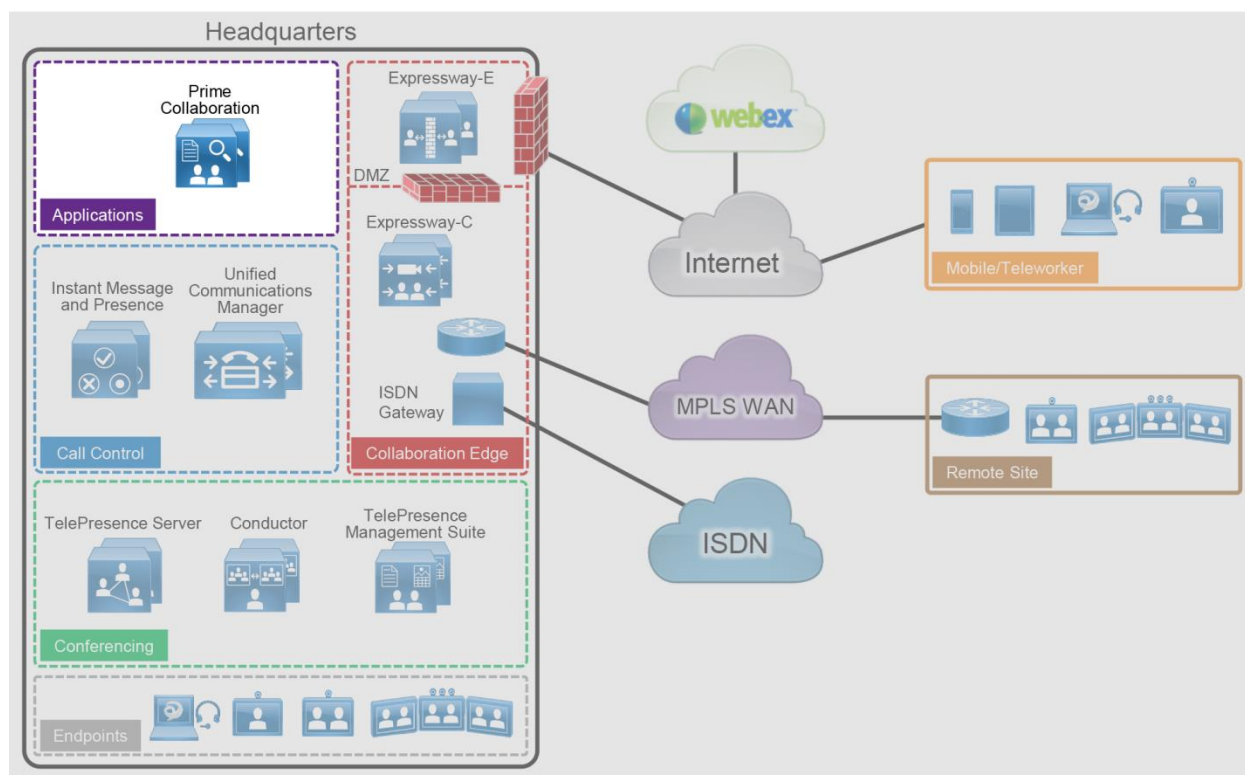

**Table 8** lists the roles of the application components in this architecture and the services they provide.

**Table 8** Components for Applications

Module	Component	Description
Applications	Cisco Prime Collaboration Deployment	Assists the administrator by automating many of the steps necessary to install a Unified CM cluster with IM and Presence Service



## Cisco Prime Collaboration

Cisco Prime Collaboration Provisioning provides a centralized provisioning interface that simplifies administration of day-to-day activities such as moves, adds, changes, and deletions (MACD) of user devices and services in an organization. Prime Collaboration Provisioning also provides a self-service portal for end users to manage their own device features.

### Recommended Deployment

A single deployment of Cisco Prime Collaboration is required per organization. Resiliency for the deployment is provided through cold standby tools within virtual machine applications. The Prime Collaboration applications connect with the various components using either command line or HTTPS access based on administrator credentials for each component.

### Benefits

Cisco Prime Collaboration provides the following benefits:

- A consistent, unified approach simplifies the management of Cisco collaboration technologies.
- Features such as bulk-based provisioning, device MACDs, and consolidated views simplify user and service-related configuration and administration.
- A self-service portal eases support by enabling users to make authorized changes.



# BE6000H Small Video Deployment

A compact model is available for small video deployments where there is an interest in minimizing the number of physical servers. In this scenario the resources required for Unified Communications applications are less stringent, allowing more applications to reside on the same physical server. This allows for a single-box solution with all necessary collaboration applications, including conferencing resources. For deployments that are expected to grow over time, the Cisco BE6000H deployment covered in previous chapters should be used.

**Figure 19** Preferred Architecture for Cisco BE6000H Small Video Deployment

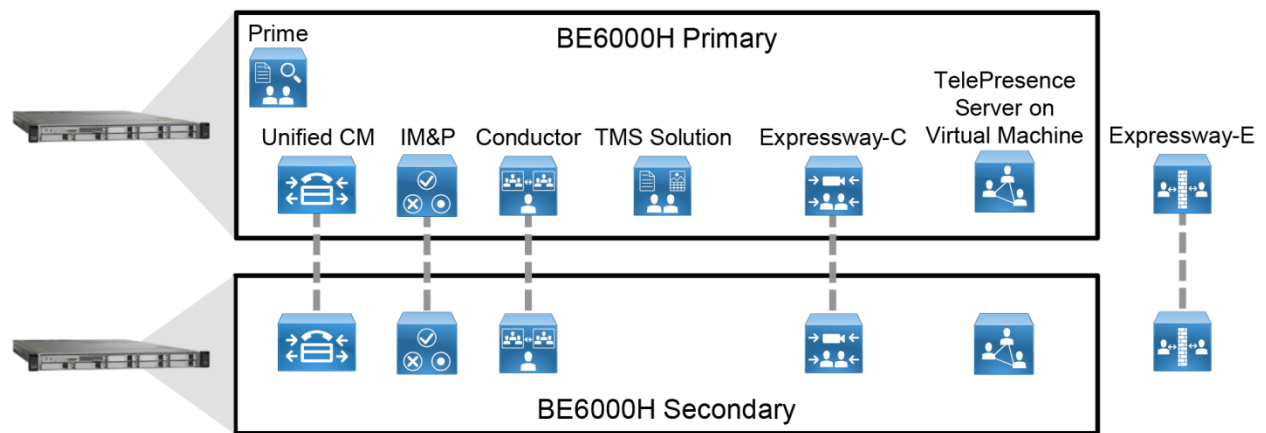

**Note:** If full redundancy is not required, a single server may be deployed without loss of functionality.

Characteristics of the BE6000H Small Video Deployment include:

- TMS Solution: TelePresence Management Suite (TMS), TelePresence Management Suite Provisioning Extension (TMSPE), TelePresence Management Suite Extension for Microsoft Exchange (TMSXE), and an embedded SQL all reside on a single virtual machine instance.
- TelePresence Server on a virtual machine deployed on the same BE6000H platform for all conference types.
- Expressway-E deployed separately on specification-based hardware. This could be Cisco ISR UCS-E series blades among other UCS models.
- TMS solution is not redundant because there is no external SQL server or load balancer deployed.

## Deployment Considerations

To achieve this compact solution, restrictions are in place for the capacity and functionality of TMS, TMSPE, and TMSXE. These restrictions include:

- TMS
  - Maximum of 200 controlled systems
  - Maximum of 100 concurrent participants
  - Maximum of 50 concurrent ongoing scheduled conferences
- TMSXE
  - Up to 50 endpoints bookable in Microsoft Exchange
- TMSPE
  - Up to 1000 Collaboration Meeting Rooms (CMR) Premises



# Appendix

## Product List

This product list identifies the Cisco products in the Preferred Architecture for Video, along with their relevant software versions.

Product	Product Description	Software
<b>Cisco Unified CM and IM and Presence Service</b>	Call control, instant messaging, and presence services	11.5(1)
<b>Cisco Expressway-C and Expressway-E</b>	Mobile and remote access and business-to-business communications	X8.8
<b>Cisco Prime Collaboration Standard</b>	Provisioning and monitoring services for voice and video deployments.	11.2
<b>Cisco TelePresence Conductor</b>	Video conferencing resource management	XC4.2
<b>Cisco TelePresence Management Suite (TMS)</b>	Scheduling, web conferencing integration, and other advanced video features	15.2
<b>Cisco TelePresence Server</b>	Video conferencing resource	4.3
<b>Cisco TelePresence ISDN Gateway</b>	H.320 gateway	2.2
<b>Cisco Jabber</b>	Soft client with integrated voice, video, voicemail, and instant messaging and presence functionality for mobile devices and personal computers	Jabber 11.6
<b>Cisco DX Series</b>	Video endpoint for the desktop	CE 8.2
<b>Cisco TelePresence MX Series</b>	TelePresence multipurpose room endpoint	CE 8.2
<b>Cisco TelePresence SX Series</b>	Integrator Series TelePresence endpoint	CE 8.2
<b>Cisco TelePresence IX Series</b>	Immersive TelePresence room endpoint	IX8.2
<b>Cisco IP Phones 8845 and 8865</b>	General office phone (video)	11.6



**Americas Headquarters**  
Cisco Systems, Inc.  
San Jose, CA

**Asia Pacific Headquarters**  
Cisco Systems (USA) Pte. Ltd.  
Singapore

**Europe Headquarters**  
Cisco Systems International BV Amsterdam,  
The Netherlands

Cisco has more than 200 offices worldwide. Addresses, phone numbers, and fax numbers are listed on the Cisco Website at [www.cisco.com/go/offices](http://www.cisco.com/go/offices).

Cisco and the Cisco Logo are trademarks of Cisco Systems, Inc. and/or its affiliates in the U.S. and other countries. A listing of Cisco's trademarks can be found at [www.cisco.com/go/trademarks](http://www.cisco.com/go/trademarks). Third party trademarks mentioned are the property of their respective owners. The use of the word partner does not imply a partnership relationship between Cisco and any other company. (1005R)