



## **Cisco IronPort AsyncOS 7.7.5 for Web User Guide**

April 10, 2013

### **Americas Headquarters**

Cisco Systems, Inc.  
170 West Tasman Drive  
San Jose, CA 95134-1706  
USA  
<http://www.cisco.com>  
Tel: 408 526-4000  
800 553-NETS (6387)  
Fax: 408 527-0883

THE SPECIFICATIONS AND INFORMATION REGARDING THE PRODUCTS IN THIS MANUAL ARE SUBJECT TO CHANGE WITHOUT NOTICE. ALL STATEMENTS, INFORMATION, AND RECOMMENDATIONS IN THIS MANUAL ARE BELIEVED TO BE ACCURATE BUT ARE PRESENTED WITHOUT WARRANTY OF ANY KIND, EXPRESS OR IMPLIED. USERS MUST TAKE FULL RESPONSIBILITY FOR THEIR APPLICATION OF ANY PRODUCTS.

THE SOFTWARE LICENSE AND LIMITED WARRANTY FOR THE ACCOMPANYING PRODUCT ARE SET FORTH IN THE INFORMATION PACKET THAT SHIPPED WITH THE PRODUCT AND ARE INCORPORATED HEREIN BY THIS REFERENCE. IF YOU ARE UNABLE TO LOCATE THE SOFTWARE LICENSE OR LIMITED WARRANTY, CONTACT YOUR CISCO REPRESENTATIVE FOR A COPY.

The Cisco implementation of TCP header compression is an adaptation of a program developed by the University of California, Berkeley (UCB) as part of UCB's public domain version of the UNIX operating system. All rights reserved. Copyright © 1981, Regents of the University of California.

NOTWITHSTANDING ANY OTHER WARRANTY HEREIN, ALL DOCUMENT FILES AND SOFTWARE OF THESE SUPPLIERS ARE PROVIDED "AS IS" WITH ALL FAULTS. CISCO AND THE ABOVE-NAMED SUPPLIERS DISCLAIM ALL WARRANTIES, EXPRESSED OR IMPLIED, INCLUDING, WITHOUT LIMITATION, THOSE OF MERCHANTABILITY, FITNESS FOR A PARTICULAR PURPOSE AND NONINFRINGEMENT OR ARISING FROM A COURSE OF DEALING, USAGE, OR TRADE PRACTICE.

IN NO EVENT SHALL CISCO OR ITS SUPPLIERS BE LIABLE FOR ANY INDIRECT, SPECIAL, CONSEQUENTIAL, OR INCIDENTAL DAMAGES, INCLUDING, WITHOUT LIMITATION, LOST PROFITS OR LOSS OR DAMAGE TO DATA ARISING OUT OF THE USE OR INABILITY TO USE THIS MANUAL, EVEN IF CISCO OR ITS SUPPLIERS HAVE BEEN ADVISED OF THE POSSIBILITY OF SUCH DAMAGES.

Cisco and the Cisco logo are trademarks or registered trademarks of Cisco and/or its affiliates in the U.S. and other countries. To view a list of Cisco trademarks, go to this URL: [www.cisco.com/go/trademarks](http://www.cisco.com/go/trademarks). Third-party trademarks mentioned are the property of their respective owners. The use of the word partner does not imply a partnership relationship between Cisco and any other company. (1110R)

Any Internet Protocol (IP) addresses and phone numbers used in this document are not intended to be actual addresses and phone numbers. Any examples, command display output, network topology diagrams, and other figures included in the document are shown for illustrative purposes only. Any use of actual IP addresses or phone numbers in illustrative content is unintentional and coincidental.

*Cisco IronPort AsyncOS 7.7.5 for Web User Guide*  
© 2013 Cisco Systems, Inc. All rights reserved.

# CONTENTS

---

**CHAPTER 1**
**Getting Started with the Web Security Appliance 1-1**

- What's New in This Release 1-1
- How to Use This Guide 1-5
  - Before You Begin 1-5
  - Where to Find More Information 1-6
    - Documentation Set 1-6
    - Security Training Services & Certification 1-6
    - Knowledge Base 1-7
    - Cisco Support Community 1-7
    - Cisco IronPort Customer Support 1-7
    - Third Party Contributors 1-8
    - Cisco Welcomes Your Comments 1-8
- Web Security Appliance Overview 1-8

---

**CHAPTER 2**
**Using the Web Security Appliance 2-1**

- Understanding How the Web Security Appliance Works 2-1
  - Web Proxy 2-1
  - The L4 Traffic Monitor 2-1
- Administering the Web Security Appliance 2-2
  - System Setup Wizard 2-2
  - Accessing the Web Security Appliance 2-2
  - Using the Command Line Interface (CLI) 2-3
    - Using an Ethernet Connection 2-3
    - Using a Serial Connection 2-3
  - Reporting and Logging 2-4
- Navigating the Web Security Appliance Web Interface 2-4
  - Logging In 2-5
  - Browser Requirements 2-6
  - Supported Languages 2-6
  - Reporting Tab 2-7
  - Web Security Manager Tab 2-7
  - Security Services Tab 2-8
  - Network Tab 2-8
  - System Administration Tab 2-9
- Committing and Clearing Changes 2-9
  - Committing and Clearing Changes in the Web Interface 2-9
    - Committing Changes in the Web Interface 2-10

Clearing Changes in the Web Interface	2-10
Committing and Clearing Changes in the CLI	2-10
Checking for Web Proxy Restart on Commit	2-10
Participating in The Cisco SensorBase Network	2-11
Sharing Data	2-12

**CHAPTER 3**

**Deployment 3-1**

Deployment Overview	3-1
Preparing for Deployment	3-1
Appliance Interfaces	3-2
Management Interface	3-3
Data Interfaces	3-3
L4 Traffic Monitor Interfaces	3-3
Example Deployment	3-4
Deploying the Web Proxy in Explicit Forward Mode	3-4
Configuring Client Applications	3-5
Connecting Appliance Interfaces	3-5
Testing an Explicit Forward Configuration	3-5
Deploying the Web Proxy in Transparent Mode	3-5
Connecting Appliance Interfaces	3-6
Connecting the Appliance to a WCCP Router	3-6
Configuring the Web Security Appliance	3-6
Configuring the WCCP Router	3-6
Example WCCP Configurations	3-8
Example 1	3-8
Example 2	3-9
Example 3	3-9
Working with Multiple Appliances and Routers	3-10
Using the Web Security Appliance in an Existing Proxy Environment	3-10
Transparent Upstream Proxy	3-11
Explicit Forward Upstream Proxy	3-11
Deploying the L4 Traffic Monitor	3-11
Connecting the L4 Traffic Monitor	3-12
Configuring an L4 Traffic Monitor Wiring Type	3-12

**CHAPTER 4**

**Installation and Configuration 4-1**

Before You Begin	4-1
Connecting a Laptop to the Appliance	4-1

Connecting the Appliance to the Network	4-2
Gathering Setup Information	4-2
DNS Support	4-4
System Setup Wizard	4-4
Accessing the System Setup Wizard	4-5
Step 1. Accept the EULA and Begin Setup	4-6
Step 2. Configure Network Settings	4-6
Step 3. Security	4-11
Step 4. Review and Install	4-13

**CHAPTER 5****Web Proxy Services 5-1**

Overview of the Web Proxy	5-1
About Web Proxy Services	5-2
Enabling Processing of HTTP Traffic	5-2
Enabling Processing of HTTPS Traffic	5-2
Web Proxy Deployment Options	5-2
Web Proxy Cache	5-3
Configuring the Web Proxy	5-3
Custom Headers	5-6
Working with FTP Connections	5-7
Using Authentication with Native FTP	5-8
Working with Native FTP in Transparent Mode	5-9
Configuring FTP Proxy Settings	5-9
Bypassing the Web Proxy	5-11
Understanding How the Proxy Bypass List Works	5-12
Using WCCP with the Proxy Bypass List	5-13
Bypassing Application Scanning from Web Proxy Scanning	5-13
Proxy Usage Agreement	5-13
Configuring Client Applications to Use the Web Proxy	5-14
Working with PAC Files	5-14
PAC File Format	5-15
Creating a PAC File for Remote Users	5-15
Specifying the PAC File in Browsers	5-16
Entering the PAC File Location	5-16
Detecting the PAC File Location Automatically	5-16
Adding PAC Files to the Web Security Appliance	5-17
Specifying the PAC File URL	5-18
Uploading PAC Files to the Appliance	5-19

Understanding WPAD Compatibility with Netscape and Firefox 5-20

Advanced Proxy Configuration 5-20

Authentication Options 5-23

Caching Options 5-27

Custom Header Options 5-30

DNS Options 5-30

EUN Options 5-32

NATIVE FTP Options 5-33

FTPOVERHTTP Options 5-35

HTTPS Options 5-35

Proxyconn Options 5-36

Scanning Options 5-36

SOCKS Options 5-36

Miscellaneous Options 5-37

**CHAPTER 6**

**SOCKS Proxy Services 6-1**

Overview of SOCKS Proxy Services 6-1

Enabling Processing of SOCKS Traffic 6-2

Configuring the SOCKS Proxy 6-2

Creating SOCKS Policies 6-2

Logging 6-4

Transaction Result Codes 6-4

Log Fields, Format Specifiers, and Field Values 6-4

**CHAPTER 7**

**Policies 7-1**

Overview of Policies 7-1

Block Versus Allow Decisions 7-2

File Types 7-2

Policy Types 7-2

Identities 7-3

Decryption Policies 7-3

Routing Policies 7-3

Access Policies 7-3

Cisco IronPort Data Security Policies 7-3

External DLP Policies 7-4

Outbound Malware Scanning Policies 7-4

SaaS Application Authentication Policies 7-4

Working with Policy Groups 7-4

Creating Policy Groups	7-5
Using the Policies Tables	7-5
Policy Group Membership	7-7
Authenticating Users versus Authorizing Users	7-7
Working with Failed Authentication and Authorization	7-8
Working with All Identities	7-8
Policy Group Membership Rules and Guidelines	7-8
Working with Time Based Policies	7-9
Creating Time Ranges	7-9
Working with User Agent Based Policies	7-10
Configuring User Agents for Policy Group Membership	7-11
Exempting User Agents from Authentication	7-12
Tracing Policies	7-12

**CHAPTER 8****Identities 8-1**

Overview of Identities	8-1
Evaluating Identity Group Membership	8-4
Understanding How Authentication Affects Identity Groups	8-5
Understanding How Authentication Affects HTTPS and FTP over HTTP Requests	8-6
Understanding How Authentication Scheme Affects Identity Groups	8-7
Matching Client Requests to Identity Groups	8-8
Allowing Guest Access to Users Who Fail Authentication	8-10
Identifying Users Transparently	8-12
Understanding Transparent User Identification	8-12
Transparent User Identification with Active Directory	8-13
Transparent User Identification with Novell eDirectory	8-15
Rules and Guidelines	8-16
Configuring Transparent User Identification	8-17
Using the CLI to Configure Transparent User Identification	8-17
Creating Identities	8-18
Configuring Identities in Other Policy Groups	8-22
Example Identity Policies Tables	8-23
Example 1	8-24
Example 2	8-25

**CHAPTER 9****Block, Allow or Redirect Transaction Requests 9-1**

Overview of Block, Allow, or Redirect Transaction Requests	9-1
Access Policy Groups	9-2

- Understanding the Monitor Action 9-3
- Evaluating Access Policy Group Membership 9-4
  - Matching Client Requests to Access Policy Groups 9-4
- Creating Access Policies 9-5
- Controlling HTTP and Native FTP Traffic 9-8
  - Protocols and User Agents 9-9
  - URL Categories 9-10
  - Applications 9-10
  - Object Blocking 9-11
  - Web Reputation and Anti-Malware 9-12
- Blocking Specific Applications and Protocols 9-12
  - Blocking on Port 80 9-12
    - Policy: Protocols and User Agents 9-12
    - Policy: URL Categories 9-14
    - Policy: Objects 9-14
  - Blocking on Ports Other Than 80 9-14

**CHAPTER 10**

- Working with External Proxies 10-1**
  - Working with External Proxies Overview 10-1
  - Routing Traffic to Upstream Proxies 10-1
    - Accessing HTTPS Sites using Routing Policies with URL Category Membership Criteria 10-2
  - Adding External Proxy Information 10-3
    - Creating Proxy Groups 10-3
  - Evaluating Routing Policy Group Membership 10-4
    - Matching Client Requests to Routing Policy Groups 10-4
  - Creating Routing Policies 10-5

**CHAPTER 11**

- Processing HTTPS Traffic 11-1**
  - Overview of Processing HTTPS Traffic 11-1
  - Decryption Policies 11-2
  - Certificates 11-3
  - Authentication and HTTPS Connections 11-5
  - Decryption with the AVC Engine 11-5
  - Decryption with AOL Instant Messenger 11-5
  - Managing Certificate Validation and Decryption for HTTPS 11-6
    - Valid Certificates 11-6
    - Invalid Certificate Handling 11-7
      - Certificates that are Invalid for Multiple Reasons 11-8



Untrusted Certificate Warnings for Decrypted Connections	11-8
Enabling HTTPS Certificate Validation and Content Decryption	11-8
Uploading a Root Certificate and Key	11-8
Generating a Certificate and Key	11-9
Configuring Decryption Options	11-10
Configuring Invalid Certificate Handling	11-10
Options for Certificate Revocation Status Checking	11-11
Enabling Real-Time Revocation Status Checking	11-12
Enabling the HTTPS Proxy	11-13
Evaluating Decryption Policy Group Membership	11-14
Matching Client Requests to Decryption Policy Groups	11-15
Creating Decryption Policies	11-16
Controlling HTTPS Traffic	11-19
Bypassing Decryption for Particular Websites	11-22
Trusted Root Certificates	11-22
Adding Certificates to the Trusted List	11-22
Removing Certificates from the Trusted List	11-22
Logging	11-23

**CHAPTER 12****Outbound Malware Scanning 12-1**

Outbound Malware Scanning Overview	12-1
User Experience with Blocked Requests	12-1
Outbound Malware Scanning Policy Groups	12-2
Evaluating Outbound Malware Scanning Policy Group Membership	12-2
Matching Client Requests to Outbound Malware Scanning Policy Groups	12-3
Creating Outbound Malware Scanning Policies	12-4
Controlling Upload Requests Using Outbound Malware Scanning Policies	12-6
Logging	12-8

**CHAPTER 13****Data Security and External DLP Policies 13-1**

Data Security and External DLP Policies Overview	13-1
Bypassing Upload Requests Below a Minimum Size	13-2
User Experience with Blocked Requests	13-2
Working with Data Security and External DLP Policies	13-3
Data Security Policy Groups	13-3
External DLP Policy Groups	13-4
Evaluating Data Security and External DLP Policy Group Membership	13-4
Matching Client Requests to Data Security and External DLP Policy Groups	13-5

- Creating Data Security and External DLP Policies 13-6
- Controlling Upload Requests Using Cisco IronPort Data Security Policies 13-9
  - URL Categories 13-11
  - Web Reputation 13-12
  - Content Blocking 13-12
- Defining External DLP Systems 13-13
  - Configuring External DLP Servers 13-14
- Controlling Upload Requests Using External DLP Policies 13-16
- Logging 13-17

**CHAPTER 14**

- Achieving Secure Mobility 14-1**
  - Achieving Secure Mobility Overview 14-1
  - Working with Remote Users 14-2
  - Enabling Secure Mobility 14-2
  - Transparently Identifying Remote Users 14-3
  - Logging 14-4
  - Configuring Secure Mobility Using the CLI 14-4

**CHAPTER 15**

- Controlling Access to SaaS Applications 15-1**
  - SaaS Access Control Overview 15-1
  - Understanding How SaaS Access Control Works 15-1
    - Authenticating SaaS Users 15-2
    - Authentication Requirements 15-4
    - Enabling SaaS Access Control 15-4
      - Understanding the Single Sign-On URL 15-4
    - Using SaaS Access Control with Multiple Appliances 15-5
  - Configuring the Appliance as an Identity Provider 15-5
  - Creating SaaS Application Authentication Policies 15-8

**CHAPTER 16**

- Notifying End Users 16-1**
  - Notifying End Users of Organization Policies 16-1
  - Configuring General Settings for Notification Pages 16-3
  - Working With On-Box End-User Notification Pages 16-3
    - Configuring On-Box End-User Notification Pages 16-4
    - Editing On-Box End-User Notification Pages 16-5
      - Rules and Guidelines for Editing On-Box End-User Notification Pages 16-8
      - Using Variables in Customized On-Box End-User Notification Pages 16-8

Defining End-User Notification Pages Off-Box	16-9
Rules and Guidelines	16-9
End-User Notification Page Parameters	16-10
Redirecting End-User Notification Pages to a Custom URL	16-11
End-User Acknowledgement Page	16-11
Accessing HTTPS and FTP Sites with the End-User Acknowledgement Page	16-14
Configuring the End-User Acknowledgement Page	16-14
Configuring the End-User URL Filtering Warning Page	16-15
Configuring FTP Notification Messages	16-16
Custom Text in Notification Pages	16-16
Supported HTML Tags in Notification Pages	16-17
Custom Text and Logos: Authentication, and End-User Acknowledgement Pages	16-17
Notification Page Types	16-18

**CHAPTER 17****URL Filters 17-1**

URL Filters Overview	17-1
Dynamic Content Analysis Engine	17-2
Uncategorized URLs	17-2
Matching URLs to URL Categories	17-3
Reporting Uncategorized and Misclassified URLs	17-3
The URL Categories Database	17-3
Configuring the URL Filtering Engine	17-4
Managing Updates to the Set of URL Categories	17-4
Understanding the Impacts of URL Category Set Updates	17-5
Effects of URL Category Set Changes on Policy Group Membership	17-5
Effects of URL Category Set Updates on Filtering Actions in Policies	17-6
Merged Categories - Examples	17-7
Controlling Updates to the URL Category Set	17-8
Manually Updating the URL Category Set	17-8
Choosing Default Settings for New and Changed Categories	17-9
Ensuring that You Receive Alerts About Category and Policy Changes	17-9
Responding to Alerts about URL Category Set Updates	17-9
Filtering Transactions Using URL Categories	17-9
Configuring URL Filters for Access Policy Groups	17-10
Configuring URL Filters for Decryption Policy Groups	17-12
Configuring URL Filters for Data Security Policy Groups	17-13
Creating and Editing Custom URL Categories	17-15
Filtering Adult Content	17-17

- Enforcing Safe Searches and Site Content Ratings: 17-18
- Logging Adult Content Access 17-18
- Redirecting Traffic 17-19
  - Logging and Reporting 17-20
  - Redirecting Traffic in the Access Policies 17-20
- Warning Users and Allowing Them to Continue 17-20
  - User Experience When Warning Users 17-21
- Creating Time Based URL Filters 17-21
- Viewing URL Filtering Activity 17-22
  - Understanding Unfiltered and Uncategorized Data 17-22
  - Access Log File 17-23
- Regular Expressions 17-23
  - Forming Regular Expressions 17-23
  - Regular Expression Character Table 17-24
- URL Category Descriptions 17-25

**CHAPTER 18**

**Understanding Application Visibility and Control 18-1**

- Controlling Applications Overview 18-1
  - User Experience with Blocked Requests 18-2
  - AVC Engine Updates 18-2
- Enabling the AVC Engine 18-2
- Understanding Application Control Settings 18-3
  - Working with Browse View 18-3
  - Working with Search View 18-5
  - Rules and Guidelines 18-6
  - Configuring Application Control Settings in an Access Policy Group 18-7
- Controlling Bandwidth 18-7
  - Configuring Overall Bandwidth Limits 18-8
  - Configuring User Bandwidth Limits 18-8
    - Configuring the Default Bandwidth Limit for an Application Type 18-9
    - Overriding the Default Bandwidth Limit for an Application Type 18-9
    - Configuring Bandwidth Controls for an Application 18-10
- Controlling Instant Messaging Traffic 18-10
- Viewing AVC Activity 18-11
  - Access Log File 18-11

**CHAPTER 19**

**Configuring Security Services 19-1**

- Configuring Security Services Overview 19-1

Web Reputation Filters Overview	19-2
Web Reputation Scores	19-2
Understanding How Web Reputation Filtering Works	19-2
Web Reputation in Access Policies	19-3
Web Reputation in Decryption Policies	19-4
Web Reputation in Cisco IronPort Data Security Policies	19-4
Anti-Malware Scanning Overview	19-4
Cisco IronPort DVS™ (Dynamic Vectoring and Streaming) Engine	19-4
Understanding How the DVS Engine Works	19-5
Working with Multiple Malware Verdicts	19-5
Webroot Scanning	19-6
McAfee Scanning	19-7
Matching Virus Signature Patterns	19-7
Heuristic Analysis	19-7
McAfee Categories	19-8
Sophos Scanning	19-8
Understanding Adaptive Scanning	19-8
Enabling Web Reputation and Anti-Malware Filters	19-9
Configuring Web Reputation and Anti-Malware in Policies	19-10
Web Reputation and Anti-Malware Settings in Access Policies	19-11
Configuring Web Reputation and Anti-Malware Settings with Adaptive Scanning Enabled	19-11
Configuring Web Reputation and Anti-Malware Settings with Adaptive Scanning Disabled	19-12
Configuring Web Reputation Scores	19-13
Configuring Web Reputation Score Thresholds for Access Policies	19-13
Configuring Web Reputation Filter Settings for Decryption Policy Groups	19-14
Configuring Web Reputation Filter Settings for Data Security Policy Groups	19-15
Maintaining the Database Tables	19-16
The Web Reputation Database	19-16
Logging	19-17
Logging Adaptive Scanning	19-17
Caching	19-17
Malware Category Descriptions	19-18

**CHAPTER 20****Authentication 20-1**

Overview of Authentication	20-1
Client Application Support	20-2
Working with Upstream Proxy Servers	20-2

- Authenticating Users **20-3**
- Working with Failed Authentication **20-3**
- Working with Windows 7 and Windows Vista **20-4**
- Understanding How Authentication Works **20-4**
  - Basic versus NTLMSSP Authentication Schemes **20-6**
  - How Web Proxy Deployment Affects Authentication **20-6**
    - Explicit Forward Deployment, Basic Authentication **20-7**
    - Transparent Deployment, Basic Authentication **20-7**
    - Explicit Forward Deployment, NTLM Authentication **20-8**
    - Transparent Deployment, NTLM Authentication **20-9**
- Working with Authentication Realms **20-10**
  - Creating Authentication Realms **20-10**
  - Deleting Authentication Realms **20-11**
- Working with Authentication Sequences **20-11**
  - Creating Authentication Sequences **20-11**
  - Deleting Authentication Sequences **20-12**
- Appliance Behavior with Multiple Authentication Realms **20-12**
- Testing Authentication Settings **20-13**
  - Testing Process **20-13**
    - LDAP Testing **20-14**
    - NTLM Testing **20-14**
  - Testing Authentication Settings in the Web Interface **20-14**
  - Testing Authentication Settings in the CLI **20-15**
- Configuring Global Authentication Settings **20-15**
- Sending Authentication Credentials Securely **20-21**
  - Uploading Certificates and Keys to Use with Credential Encryption and SaaS Access Control **20-21**
  - Accessing HTTPS and FTP Sites with Credential Encryption Enabled **20-22**
- Allowing Users to Re-Authenticate **20-22**
  - Using Re-Authentication with Internet Explorer **20-23**
  - Using Re-Authentication with PAC Files **20-24**
- Tracking Authenticated Users **20-24**
- Bypassing Authentication **20-25**
- LDAP Authentication **20-26**
  - Changing Active Directory Passwords **20-26**
  - LDAP Authentication Settings **20-27**
  - LDAP Group Authorization **20-29**
- NTLM Authentication **20-31**
  - Authenticating Users Against Multiple Active Directory Domains **20-31**

NTLM Authentication Settings	20-33
Joining the Active Directory Domain	20-34
Supported Authentication Characters	20-36
Active Directory Server Supported Characters	20-37
LDAP Server Supported Characters	20-38

**CHAPTER 21****L4 Traffic Monitor 21-1**

About L4 Traffic Monitor	21-1
Understanding How the L4 Traffic Monitor Works	21-1
The L4 Traffic Monitor Database	21-2
Configuring the L4 Traffic Monitor	21-2
Configuring L4 Traffic Monitor Global Settings	21-3
Updating L4 Traffic Monitor Anti-Malware Rules	21-3
Configuring L4 Traffic Monitor Policies	21-3
Valid Formats	21-5
Viewing L4 Traffic Monitor Activity	21-5
Monitoring Activity and Viewing Summary Statistics	21-6
L4 Traffic Monitor Log File Entries	21-6

**CHAPTER 22****Reporting 22-1**

Reporting Overview	22-1
Working with Usernames in Reports	22-1
Report Pages	22-2
Using the Reporting Tab	22-2
Changing the Time Range	22-2
Searching Data	22-3
Choosing Which Data to Chart	22-4
Working with Columns on Report Pages	22-4
Configuring Columns on Report Pages	22-6
Subdomains vs. Second-Level Domains in Reporting and Tracking	22-6
Printing and Exporting Reports from Report Pages	22-6
Exporting Report Data	22-7
Enabling Centralized Reporting	22-8
Scheduling Reports	22-8
Adding a Scheduled Report	22-9
Editing Scheduled Reports	22-9
Deleting Scheduled Reports	22-9
Generating Reports On Demand	22-9

- Archived Reports 22-10
- SNMP Monitoring 22-10
  - MIB Files 22-11
  - Hardware Objects 22-11
    - Hardware Traps 22-12
  - SNMP Traps 22-12
    - CLI Example 22-12

**CHAPTER 23**

**Web Security Appliance Reports 23-1**

- Overview Page 23-1
- Users Page 23-5
  - User Details Page 23-6
- Web Sites Page 23-8
- URL Categories Page 23-10
  - URL Category Set Updates and Reports 23-12
    - Using The URL Categories Page in Conjunction with Other Reporting Pages 23-12
- Application Visibility Page 23-13
- Anti-Malware Page 23-15
  - Malware Category Report Page 23-17
  - Malware Threat Report Page 23-18
- Client Malware Risk Page 23-19
  - Client Detail Page for Web Proxy - Clients by Malware Risk 23-21
- Web Reputation Filters Page 23-22
- L4 Traffic Monitor Page 23-24
- SOCKS Proxy Page 23-28
- Reports by User Location Page 23-30
- Web Tracking Page 23-32
  - Searching for Transactions Processed by the Web Proxy 23-32
  - Searching for Transactions Processed by the L4 Traffic Monitor 23-35
  - Searching for Transactions Processed by the SOCKS Proxy 23-35
- System Capacity Page 23-36
  - Interpreting the Data You See on System Capacity Page 23-37
- System Status Page 23-38

**CHAPTER 24**

**Logging 24-1**

- Logging Overview 24-1
  - Log File Types 24-1
  - Web Proxy Logging 24-6



Working with Log Subscriptions	24-7
Log File Name and Appliance Directory Structure	24-8
Rolling Over Log Subscriptions	24-8
Manually Rolling Over Log Subscriptions Using the GUI	24-9
Automatically Rolling Over Log Subscriptions	24-9
Working with Compressed Log Files	24-10
Viewing the Most Recent Log Files	24-10
Configuring Host Keys	24-10
Adding and Editing Log Subscriptions	24-11
Deleting a Log Subscription	24-14
Access Log File	24-14
Transaction Result Codes	24-17
ACL Decision Tags	24-17
Understanding Scanning Verdict Information	24-21
Web Reputation Filters Example	24-25
Anti-Malware Request Example	24-25
Anti-Malware Response Example	24-25
W3C Compliant Access Logs	24-26
W3C Log File Headers	24-26
Working with Log Fields in W3C Access Logs	24-27
Custom Formatting in Access Logs and W3C Logs	24-28
Configuring Custom Formatting in Access Logs	24-36
Configuring Custom Formatting in W3C Logs	24-36
Including HTTP/HTTPS Headers in Log Files	24-37
Malware Scanning Verdict Values	24-38
Traffic Monitor Log	24-39
Troubleshooting	24-39

**CHAPTER 25**

<b>Configuring Network Settings</b>	<b>25-1</b>
Changing the System Hostname	25-1
Configuring Network Interfaces	25-2
Configuring the Data Interfaces	25-2
Configuring the Network Interfaces from the Web Interface	25-3
Configuring TCP/IP Traffic Routes	25-4
Modifying the Default Route	25-5
Working With Routing Tables	25-6
Adding a Route	25-6
Virtual Local Area Networks (VLANs)	25-6

- VLANs and Physical Ports 25-7
- Managing VLANs 25-7
  - Creating a New VLAN via the etherconfig Command 25-7
  - Creating an IP Interface on a VLAN via the interfaceconfig Command 25-10
- Configuring Transparent Redirection 25-11
  - Working with WCCP Services 25-12
  - Working with the Assignment Method 25-12
  - Working with the Forwarding and Return Method 25-13
  - IP Spoofing when Using WCCP 25-13
  - Adding and Editing a WCCP Service 25-14
  - Deleting a WCCP Service 25-15
- Configuring SMTP Relay Hosts 25-16
  - Configuring SMTP from the Web Interface 25-16
  - Configuring SMTP from the CLI 25-17
- Configuring DNS Server(s) 25-17
  - Specifying DNS Servers 25-17
  - Split DNS 25-17
  - Using the Internet Root Servers 25-18
  - Multiple Entries and Priority 25-18
  - DNS Alert 25-18
  - Clearing the DNS Cache 25-18
  - Editing DNS Settings 25-19

**CHAPTER 26**

**System Administration 26-1**

- Managing the S-Series Appliance 26-1
  - Saving and Loading the Appliance Configuration 26-1
  - Committing Changes to the Appliance Configuration 26-2
- Support Commands 26-2
  - Opening a Support Case 26-3
  - Remote Access 26-3
  - Packet Capture 26-4
    - Starting a Packet Capture 26-5
    - Editing Packet Capture Settings 26-5
- Working with Feature Keys 26-6
  - Feature Keys Page 26-7
  - Feature Key Settings Page 26-7
  - Expired Feature Keys 26-8
- Administering User Accounts 26-8
  - Managing Local Users 26-9

Adding Local Users	26-10
Deleting Users	26-10
Editing Users	26-10
Changing Passwords	26-11
Monitoring Users from the CLI	26-11
Using External Authentication	26-12
Enabling External Authentication Using RADIUS	26-13
Defining User Preferences	26-14
Configuring Administrator Settings	26-14
Configuring Custom Text at Login	26-14
Configuring IP-Based Administrator Access	26-15
Configuring the SSL Ciphers for Administrator Access	26-15
Configuring the Return Address for Generated Messages	26-15
Managing Alerts	26-16
Alerting Overview	26-16
Alerts: Alert Recipients, Alert Classifications, and Severities	26-16
Alert Settings	26-17
Cisco IronPort AutoSupport	26-18
Alert Messages	26-18
Alert From Address	26-18
Alert Subject	26-18
Example Alert Message	26-19
Managing Alert Recipients	26-19
Adding New Alert Recipients	26-20
Configuring Existing Alert Recipients	26-20
Deleting Alert Recipients	26-20
Configuring Alert Settings	26-21
Editing Alert Settings	26-21
Alert Listing	26-21
Feature Key Alerts	26-22
Hardware Alerts	26-22
Logging Alerts	26-22
Reporting Alerts	26-23
System Alerts	26-25
Updater Alerts	26-26
FIPS Compliance	26-26
FIPS Certificate Requirements	26-27
Entering and Exiting FIPS Mode	26-27
Web Interface	26-27

- Command Line Interface 26-27
- System Date and Time Management 26-27
  - System Date and Time Management Using the CLI 26-28
  - System Date and Time Management Using the GUI 26-28
    - GMT Offsets 26-28
    - Setting the Time Zone 26-28
    - Synchronizing the System Clock with an NTP Server 26-29
    - Deleting an NTP Server from the Configuration 26-29
    - Manually Setting the System Date and Time in the GUI 26-29
- Installing a Server Digital Certificate 26-29
  - Obtaining Certificates 26-30
    - Intermediate Certificates 26-31
  - Uploading Certificates to the Web Security Appliance 26-31
- Upgrading AsyncOS for Web 26-33
  - Available Upgrade Notifications 26-33
  - Upgrading AsyncOS for Web from the Web Interface 26-34
  - Upgrading AsyncOS for Web from the CLI 26-35
    - Differences from Traditional Upgrading Method 26-35
- Configuring Upgrade and Service Update Settings 26-35
  - Updating and Upgrading from the Cisco IronPort Update Servers 26-36
    - Configuring a Static Address for the Cisco IronPort Update Servers 26-36
  - Upgrading from a Local Server 26-37
    - Hardware and Software Requirements for Local Upgrade Servers 26-38
  - Configuring the Update and Upgrade Settings from the Web Interface 26-38
  - Configuring the Update and Upgrade Settings from the CLI 26-40
  - Manually Updating Security Service Components 26-40
- Reverting to a Previous Version of AsyncOS for Web 26-40
  - Reverting AsyncOS for an Appliance Managed by the SMA 26-41
    - Available Versions 26-41
    - Important Note About Reversion Impact 26-41
  - Reverting AsyncOS for Web to a Previous Version 26-42

**CHAPTER 27**

**Command Line Interface 27-1**

- The Command Line Interface Overview 27-1
- Using the Command Line Interface 27-1
  - Accessing the Command Line Interface 27-1
  - Working with the Command Prompt 27-2
  - Command Syntax 27-2
  - Select Lists 27-3

Yes/No Queries	27-3
Subcommands	27-3
Escaping Subcommands	27-4
Command History	27-4
Completing Commands	27-4
Committing Configuration Changes	27-4
General Purpose CLI Commands	27-4
Committing Configuration Changes	27-5
Clearing Configuration Changes	27-5
Exiting the Command Line Interface Session	27-5
Seeking Help on the Command Line Interface	27-6
Web Security Appliance CLI Commands	27-6

**CHAPTER 28****Common Tasks 28-1**

Preventing Users from Accessing Streaming Media Websites During Business Hours	28-2
Bypassing Authentication for Specific User Agents	28-4
Bypassing Authentication for Specific Websites	28-5
Bypassing Decryption for specific HTTPS Websites	28-7
Bypassing Web Reputation Filtering without Bypassing Anti-Malware Scanning	28-9
Creating Access Policies for Active Directory User Groups	28-11
Automating Log File Transfers	28-13
Redirecting Web Traffic	28-14

**APPENDIX A****HTTPS Reference A-1**

Overview of HTTPS	A-1
Digital Cryptography Terms	A-2
HTTPS Basics	A-3
SSL Handshake	A-4
Digital Certificates	A-5
Validating Certificate Authorities	A-5
Decrypting HTTPS Traffic	A-6
Mimicking the Server Digital Certificate	A-8
Working with Root Certificates	A-8
Converting Certificate and Key Formats	A-9

**APPENDIX A****Supplemental End User License Agreement for Cisco Systems Email and Web Security Software A-1****INDEX**



# 1

## Getting Started with the Web Security Appliance

---

The *Cisco AsyncOS for Web User Guide* provides instructions for setting up, administering, and monitoring the Cisco IronPort Web Security appliance. These instructions are designed for an experienced system administrator with knowledge of networking and web administration.

- [What's New in This Release, page 1-1](#)
- [How to Use This Guide, page 1-6](#)
- [Web Security Appliance Overview, page 1-9](#)

### What's New in This Release

This section describes the new features and enhancements in AsyncOS for Web 7.7.5. For more information about the release, see the product release notes, which are available on the Cisco IronPort Customer Support site at the following URL:

<http://www.cisco.com/web/ironport/index.html>

**Note**

---

You need a Cisco.com User ID to access the site. If you do not have a Cisco.com User ID, you can register for one here: <https://tools.cisco.com/RPF/register/register.do>

---

You might also find it useful to review release notes for earlier releases to see the features and enhancements that were previously added.

Table 1-1 describes the new features and enhancements that have been added in the Cisco IronPort AsyncOS 7.7.5 for Web release.

**Table 1-1 New Features for AsyncOS 7.7.5 for Web**

Feature	Description
<b>New Features</b>	
Cisco Web Security Virtual Appliance	<p>Cisco offers the Cisco Web Security appliance as a virtual machine that you can host on your own network.</p> <p>The virtual appliance requires a separate license for the virtual appliance purchased from Cisco and a Cisco UCS Server (Blade or Rack-Mounted) hardware platform running VMware ESXi version 4.x or 5.0.</p> <p>The <i>Cisco Security Virtual Appliance Installation Guide</i> includes more information on the requirements for the virtual appliance.</p> <p>The new Web Security virtual appliance models and configurations are:</p> <ul style="list-style-type: none"> <li>• S000V (250 GB disk space, 50 GB cache space, 1 core, 4 GB memory)</li> <li>• S100V (250 GB disk space, 50 GB cache space, 2 cores, 6 GB memory)</li> <li>• S300V (1024 GB disk space, 200 GB cache space, 4 cores, 8 GB memory)</li> </ul> <p>This feature includes the following changes to AsyncOs for Web:</p> <ul style="list-style-type: none"> <li>• The Web Security virtual appliance license allows you to clone and run multiple virtual appliances on your network.</li> <li>• The <code>loadlicense</code> CLI command for installing the virtual appliance license. You can use the same license for multiple virtual appliances.</li> <li>• Feature keys are included as part of the virtual appliance license. The feature keys will expire at the same time as the license. Purchasing new feature keys will require downloading and installing a new virtual appliance license.</li> <li>• Due to feature keys being included in the virtual appliance license, there are no 30-day evaluations for AsyncOS features.</li> <li>• You cannot open a Technical Support tunnel before installing the virtual appliance license.</li> <li>• The <code>version</code>, <code>ipcheck</code>, and <code>supportrequest</code> CLI commands have also been updated to included virtual appliance information.</li> <li>• There are new alerts and logs for misconfigured virtual appliances.</li> </ul>
Multi-Forest NTLM	<p>Configure the Web Security Appliance to authenticate users from Multiple untrusted NTLM realms. Sometimes creating trust relationships between distinct NTLM realms is not practical. You can now support these configurations using the same WSA without expending the cost and effort associated with enabling NTLM trust.</p> <p>Authenticate users from multiple NTLM realms if those realms possess a trust relationship. Create multiple identity policies using these untrusted NTLM realms and then configure user and group policies associated with these identities. For more information, see <a href="#">Authenticating Users Against Multiple Active Directory Domains, page 20-31</a>.</p>



**Table 1-1** *New Features for AsyncOS 7.7.5 for Web (continued)*

<b>Feature</b>	<b>Description</b>
Software-based FIPS Level 1 Compliance	<p>The Federal Information Processing Standard (FIPS) 140-2 is a publicly announced standard developed jointly by the United States and Canadian federal governments specifying requirements for cryptographic modules that are used by all government agencies to protect sensitive but unclassified information. With AsyncOS 7.7 for Web, FIPS 140-2 Level 1 compliance can be enabled via a few simple steps in the Web Security Appliance GUI.</p> <p>This feature utilizes the Cisco Common Crypto Module (C3M) rather than the previously used Hardware Security Module (HSM) for all cryptographic operations and it will be available via AsyncOS 7.7 for Web running on all currently supported hardware models. For more information, see <a href="#">FIPS Compliance, page 26-27</a>.</p>
SOCKS Proxy	<p>Support for SOCKS-based applications, including Bloomberg Terminals. Define SOCKS-specific user and group policies as well as specific TCP and UDP destination ports. SOCKS logs and reports allow you to track and analyze SOCKS proxy usage. For more information see <a href="#">Overview of SOCKS Proxy Services, page 6-1</a>.</p>
Customer Header Insertion	<p>Insert custom request headers. Certain websites such as YouTube for Schools require that web requests to their domains be appended with customized header strings. In the case of YouTube for Schools, an account-specific string must be sent with each request to YouTube's domains so that YouTube can recognize users from a Schools account and serve content accordingly. This function allows you to utilize the CLI to specify the customer header string and the domains for which requests will be appended.</p>
OCSP	<p>Use the Online Certificate Status Protocol (OCSP) to provide revocation status updates for X.509 certificates. OCSP provides a more timely means of validation for certificates than the alternative Certificate Revocation Lists (CRL).</p> <p>Currently, the administrator can configure the invalid certificate handling policies under the HTTPS Proxy page. Enable/disable OCSP and configure new OCSP policies using the Web UI. Configure timeout values, and select a configured upstream proxy group. Configure a list of exempt servers that WSA will connect to directly without using the upstream proxy. For more information, see <a href="#">Enabling Real-Time Revocation Status Checking, page 11-12</a>.</p>
Certificate Trust Store Management	<p>Greater management control of the certificates and certificate authorities on. View all of the Cisco-bundled certificates, remove trust of any Cisco-trusted root certificate authorities, and view the Cisco-published blacklist This will enable you more flexibility in making your own decisions with regards to acceptable and unacceptable certificates used by the WSA.</p> <p>Within the Web UI, import your own trusted certificates and add them to the trusted root certificate list. View current Cisco-trusted root certificates and select an option to override each individual certificate, removing trust by the WSA for that certificate. View Cisco's intermediate certificate blacklist. Due to real-life incidents where certain intermediate CA's were compromised, the WSA was given a hard-coded list of blacklisted intermediate certificates that was previously transparent to administrators. This now becomes a viewable list. For more information, see <a href="#">Adding Certificates to the Trusted List, page 11-22</a> and <a href="#">Removing Certificates from the Trusted List, page 11-23</a>.</p>

**Table 1-1** *New Features for AsyncOS 7.7.5 for Web (continued)*

Feature	Description
Encrypted Private Keys	Use encrypted, password-protected private keys. Upload encrypted private keys and provide a password for the WSA to decrypt them. The WSA then stores these private keys by obfuscating/encrypting them with a password that is unknown to the user. When configurations are exported to a file, private keys remain obfuscated and unreadable to the user. The WSA can decrypt them when the configuration is loaded onto a WSA. For more information, <a href="#">Uploading a Root Certificate and Key, page 11-9</a> .
<b>Enhancements</b>	
SNI extension for Transparent SSL Handshake	Access the Server Name Indication (SNI) extension to parse the destination server name. This is useful when making requests to virtual servers hosting multiple HTTPS websites such as youtube.com and google.com. [Defect Number: 74969]
Enhanced: Native FTP Proxy	<p>AsyncOS for Web 7.5 includes several enhancements to native FTP functionality.</p> <ul style="list-style-type: none"> <li>• You can use spaces and the @ character in FTP user names and passwords. However, you must precede these characters with a backslash character (\). [Defect IDs: 52183 and 55380]</li> <li>• FTP clients can specify any TCP port for the control connection as long as they use proper formatting (hostname:port). [Defect ID: 55044]</li> <li>• Regardless of which mode the FTP client uses to connect to the FTP Proxy, the FTP Proxy first attempts to use passive mode to connect to the FTP server. However, if the FTP server does not allow passive mode, the FTP Proxy uses active mode. [Defect ID: 51308]</li> <li>• The FTP notification message defined on the appliance is displayed to native FTP clients when the FTP Proxy cannot establish a connection with the FTP server for any reason, such as an error with FTP Proxy authentication or a bad reputation for the server domain name. Previously, it was only displayed when there was an error with FTP Proxy authentication.</li> <li>• Access logs now include entries for when users first start a native FTP session. Search the access log file for “FTP_CONNECT” (explicit forward connections) and “FTP_TUNNEL” (transparent connections).</li> <li>• The following FTP commands are now supported: <ul style="list-style-type: none"> <li>– XMKD, XRMD, XPWD, XCUP [Defect ID: 67985]</li> <li>– REST, APPE [Defect ID: 70135]</li> <li>– STOU</li> </ul> </li> <li>• The ports defined for the Active Mode Data Port Range now apply to FTP over HTTP transactions as well as native FTP transactions.</li> <li>• The FTP Proxy now supports Trivial Virtual File Store (TVFS) FTP extensions.</li> </ul>

**Table 1-1** *New Features for AsyncOS 7.7.5 for Web (continued)*

<b>Feature</b>	<b>Description</b>
Enhanced: L4 Traffic Monitor Reporting and Tracking	<p>In AsyncOS for Web 7.5, enhancements have been made to the L4 Traffic Monitor report to improve your ability to determine whether blocking a site or a port is the more effective solution to a particular malware problem, or whether to take action specific to a particular client IP address that is at unusually high risk.</p> <ul style="list-style-type: none"> <li>You can view a list of top client IP addresses accessing malware sites, and filter these results by port.</li> <li>You can filter top malware sites by port.</li> <li>You can click the data in a table in the report to view details for a suspect site, port, or client IP address.</li> <li>You can perform multi-dimensional searches for malware risk areas, for example by hostname and port.</li> </ul> <p>For more information, see <a href="#">L4 Traffic Monitor Page, page 23-24</a>.</p>
Enhanced: External Authentication	<p>In AsyncOS for Web 7.5, when using external authentication, you can map all RADIUS users to the Administrator user role type or you can map RADIUS users to different Web Security appliance user role types.</p> <p>To map RADIUS users to different Web Security appliance user role types, you assign a role type, such as Administrator and Operator, to a RADIUS CLASS attribute. Mapping different role types lets you specify the authorization level for each RADIUS user.</p> <p>For more information, see <a href="#">RADIUS User Authentication, page 26-12</a>.</p>
Enhanced: End-User Acknowledgement Page	<p>AsyncOS for Web 7.5 can track users who have accepted the end-user acknowledgement page by session cookie or IP address when no username is available. Previously, it could only track users by IP address when no username was available.</p> <p>Also, AsyncOS for Web now remembers when a user accepted the end-user acknowledgement page even after the Web Proxy restarts.</p> <p>For more information, see <a href="#">End-User Acknowledgement Page, page 16-11</a>.</p>
Enhanced: WCCP	<p>AsyncOS for Web 7.5 has enhanced WCCP robustness. For example, deploying a new configuration does not cause the Web Proxy to renegotiate WCCP communication.</p>
Enhanced: Syslog Support	<p>AsyncOS for Web 7.5 supports Syslog Push for access logs.</p> <p>[Defect ID: 33010]</p>
Enhanced: Authentication	<p>In AsyncOS for Web 7.5, you can configure Web Proxy to automatically restart the internal authentication process that communicates with Active Directory servers when it becomes unresponsive, but is still running. Do this using the <code>advancedproxyconfig &gt; authentication</code> CLI command.</p> <p>[Defect ID: 35038]</p>
Enhanced: On-Box End-User Notification Pages	<p>AsyncOS for Web 7.5 has updated the look and feel of the default on-box end-user notification pages to make them more clear and easier to read. Customized on-box end-user notification pages are not affected.</p>

**Table 1-1** *New Features for AsyncOS 7.7.5 for Web (continued)*

Feature	Description
Enhanced: SNMP MIB	AsyncOS for Web 7.5 uses 64-bit values for many counters in the SNMP MIB file instead of 32-bit values. This reduces the likelihood that the values will roll over when the appliance is under heavy load.  [Defect ID: 72555]
Enhanced: PAC File Hosting	AsyncOS for Web 7.5 includes improvements to hosting PAC files on the Web Security appliance. <ul style="list-style-type: none"> <li>You can now replace an existing PAC file with a new version of the file with the same name. When you upload a PAC file that has the same name of an already uploaded PAC file, the GUI asks if you want to replace the current file with the new file.</li> <li>You can also delete existing PAC files using the Delete button icon.</li> <li>When you add a new row in the Hostnames for Serving PAC Files Directly section, the default PAC file is the first file uploaded to the appliance.</li> </ul> [Defect ID: 78598]
Enhanced: Authentication with Machine Credentials	In AsyncOS for Web 7.5, you can configure a timeout value to use when it processes machine credentials for authentication from Windows machines that uses NCSI.  Windows 7 and Windows Vista machines have a feature called Network Connectivity Status Indicator (NCSI). When clients on your network use NCSI and the Web Security appliance uses NTLMSSP authentication, you should configure the appliance so it uses a relatively small timeout value for machine credentials. Do this using the <code>advancedproxyconfig &gt; authentication</code> CLI command:  For more information, see <a href="#">Working with Windows 7 and Windows Vista, page 20-4</a> .  [Defect ID: 75073]

## How to Use This Guide

Use this guide as a resource to learn about the features of your appliance. The topics are organized in a logical order. You might not need to read every chapter in the book.

You can also use this guide as a reference book. It contains important information, such as network and firewall configuration settings, that you can refer to throughout the life of the appliance.

The guide is distributed as PDF and HTML files. The electronic versions of the guide are available on the Cisco IronPort Customer Support site. You can also access the HTML online help version of the book directly from the appliance GUI by clicking the Help and Support link in the upper-right corner.

## Before You Begin

Before you read this guide, review the *Quick Start Guide* for your appliance and the latest release notes for your product. In this guide, it is assumed that you have unpacked the appliance, physically installed it in a rack, and turned it on.

**Note**

If you have already cabled your appliance to your network, ensure that the default IP address for the IronPort appliance does not conflict with other IP addresses on your network. The IP address that is pre-configured on the Management port is 192.168.42.42.

## Where to Find More Information

Cisco IronPort offers the following resources to learn more about the Security Management appliance and related products:

- [Documentation Set, page 1-7](#)
- [Training, page 1-8](#)
- [Knowledge Base, page 1-8](#)
- [Cisco Support Community, page 1-9](#)
- [Customer Support, page 1-9](#)
- [Third Party Contributors, page 1-8](#)

## Documentation Set

The documentation set for Cisco IronPort appliances includes the following documents and books (not all types are available for all appliances and releases):

- *Cisco AsyncOS for Web User Guide* (this book)
- *IronPort AsyncOS CLI Reference Guide*

This and other documentation is available at the following locations:

Documentation For Cisco IronPort Products:	Is Located At:
Security Management appliances	<a href="http://www.cisco.com/en/US/products/ps10155/tsd_products_support_series_home.html">http://www.cisco.com/en/US/products/ps10155/tsd_products_support_series_home.html</a>
Email Security appliances and the CLI reference guide	<a href="http://www.cisco.com/en/US/products/ps10154/tsd_products_support_series_home.html">http://www.cisco.com/en/US/products/ps10154/tsd_products_support_series_home.html</a>
Web Security appliances	<a href="http://www.cisco.com/en/US/products/ps10164/tsd_products_support_series_home.html">http://www.cisco.com/en/US/products/ps10164/tsd_products_support_series_home.html</a>
Cisco IronPort Encryption	<a href="http://www.cisco.com/en/US/partner/products/ps10602/tsd_products_support_series_home.html">http://www.cisco.com/en/US/partner/products/ps10602/tsd_products_support_series_home.html</a>

The guide is distributed as PDF and HTML files. The electronic versions of the guide are available on the Cisco IronPort Customer Support site. You can also access the HTML online help version of the user guide directly from the appliance GUI by clicking **Help** and **Support** in the upper-right corner.

## Third Party Contributors

Some software included within Cisco IronPort AsyncOS is distributed under the terms, notices, and conditions of software license agreements of FreeBSD, Inc., Stichting Mathematisch Centrum, Corporation for National Research Initiatives, Inc., and other third party contributors, and all such terms and conditions are incorporated in Cisco IronPort license agreements.

Information about third-party licenses is available in a Licensing document at: [http://www.cisco.com/en/US/products/ps10155/prod\\_release\\_notes\\_list.html](http://www.cisco.com/en/US/products/ps10155/prod_release_notes_list.html) and at [https://support.ironport.com/3rdparty/AsyncOS\\_User\\_Guide-1-1.html](https://support.ironport.com/3rdparty/AsyncOS_User_Guide-1-1.html).

Portions of the software within Cisco IronPort AsyncOS is based upon the RRDtool with the express written consent of Tobi Oetiker.

Portions of this document are reproduced with permission of Dell Computer Corporation. Portions of this document are reproduced with permission of McAfee, Inc. Portions of this document are reproduced with permission of Sophos Plc.

## Training

For training options, see:

- [http://www.cisco.com/web/learning/le31/email\\_sec/index.html](http://www.cisco.com/web/learning/le31/email_sec/index.html)
- <http://www.cisco.com/web/learning/training-index.html>
- [stbu-trg@cisco.com](mailto:stbu-trg@cisco.com)

## Knowledge Base

You can access the Cisco IronPort Knowledge Base on the Cisco IronPort Customer Support site at the following URL:

<http://www.cisco.com/web/ironport/knowledgebase.html>



### Note

You need a Cisco.com User ID to access the site. If you do not have a Cisco.com User ID, you can register for one here: <https://tools.cisco.com/RPF/register/register.do>

The Knowledge Base contains a wealth of information on topics related to Cisco IronPort products.

Articles generally fall into one of the following categories:

- **How-To.** These articles explain how to do something with a Cisco IronPort product. For example, a how-to article might explain the procedures for backing up and restoring a database for an appliance.
- **Problem-and-Solution.** A problem-and-solution article addresses a particular error or issue that you might encounter when using a Cisco IronPort product. For example, a problem-and-solution article might explain what to do if a specific error message is displayed when you upgrade to a new version of the product.
- **Reference.** Reference articles typically provide lists of information, such as the error codes associated with a particular piece of hardware.
- **Troubleshooting.** Troubleshooting articles explain how to analyze and resolve common issues related to Cisco IronPort products. For example, a troubleshooting article might provide steps to follow if you are having problems with DNS.

## Cisco Support Community

Cisco Support Community is an online forum for Cisco customers, partners, and employees. It provides a place to discuss general email and web security issues, as well as technical information about specific Cisco products. You can post topics to the forum to ask questions and share information with other Cisco and Cisco IronPort users.

Access the Cisco Support Community at the following URLs:

- For email security and associated management:  
<https://supportforums.cisco.com/community/netpro/security/email>
- For web security and associated management:  
<https://supportforums.cisco.com/community/netpro/security/web>

## Customer Support

Use the following methods to obtain support:

U.S.: Call 1 (408) 526-7209 or Toll-free 1 (800) 553-2447

International: [http://www.cisco.com/en/US/support/tsd\\_cisco\\_worldwide\\_contacts.html](http://www.cisco.com/en/US/support/tsd_cisco_worldwide_contacts.html)

Support Site: [http://www.cisco.com/en/US/products/ps11169/serv\\_group\\_home.html](http://www.cisco.com/en/US/products/ps11169/serv_group_home.html)

If you purchased support through a reseller or another supplier, please contact that supplier directly with your product support issues.

## Cisco Welcomes Your Comments

The Cisco IronPort Technical Publications team is interested in improving the product documentation. Your comments and suggestions are always welcome. You can send comments to the following email address:

`contentsecuritydocs@cisco.com`

Please include the title of this book and the publication date from the title page in the subject line of your message.

## Web Security Appliance Overview

The Web Security appliance is a robust, secure, efficient device that protects corporate networks against web-based malware and spyware programs that can compromise corporate security and expose intellectual property. The Web Security appliance includes protection for standard communication protocols, such as HTTP, HTTPS, FTP, and SOCKS.

Malware (“malicious software”) is software designed to infiltrate or damage a computer system without the owner’s consent. It can be any kind of hostile, intrusive, or annoying software or program code. Web-based malware includes spyware, system monitors, adware, phishing and pharming techniques, keystroke (key) loggers, browser hijackers, trojan horses, and more.

Web-based malware is a rapidly growing threat, responsible for significant corporate downtime, productivity losses and major strains on IT resources. Additionally, companies run the risk of violating compliance and data privacy regulations if their networks become compromised by malware. Companies run the risk of expensive legal costs and exposure of intellectual property.

The best place to stop these threats from entering the network is right at the gateway. The Web Security appliance provides deep application content inspection, by offering a web proxy service and by monitoring layer 4 traffic. The Web Proxy and Layer 4 Traffic Monitor allow organizations to ensure breadth of coverage within their networks. The Web Security appliance provides a powerful web security platform to protect your organization against malware that is optimized for performance and efficacy.



# 2

## Using the Web Security Appliance

---

- [Understanding How the Web Security Appliance Works, page 2-1](#)
- [Administering the Web Security Appliance, page 2-2](#)
- [Navigating the Web Security Appliance Web Interface, page 2-4](#)
- [Committing and Clearing Changes, page 2-9](#)
- [Participating in The Cisco SensorBase Network, page 2-11](#)

## Understanding How the Web Security Appliance Works

The Web Proxy and the L4 Traffic Monitor are independent services. They are enabled and configured separately to provide the highest level of protection against a broad range of web-based malware threats.

The Web Proxy and L4 Traffic Monitor use data that is stored in filtering tables to evaluate and match URL request attributes such as domain names, and IP address path segments with locally maintained database records. If a match occurs, Access Policy settings determine an action to block or monitor the traffic. If no match occurs, processing continues.

### Web Proxy

The Web Security appliance Web Proxy supports the following security features:

- **Policy groups** — Policy groups allow administrators to create groups of users and apply different levels of category-based access control to each group.
- **URL Filtering Categories** — You can configure how the appliance handles each web transaction based on the URL category of a particular HTTP request.
- **Applications** — The Application Visibility and Control engine (AVC engine) enables administrators to apply deeper controls to particular application types.
- **Web Reputation Filters** — Reputation filters analyze web server behavior and characteristics to identify suspicious activity and protect against URL-based malware threats.
- **Anti-Malware Services** — The Cisco IronPort DVS™ engine in combination with the Webroot™ and McAfee scanning engines identify and stop a broad range of web-based malware threats.

For detailed information about Web Proxy services, see [Web Proxy Services, page 5-1](#).

### The L4 Traffic Monitor

The L4 Traffic Monitor is a configurable service that listens and monitors network ports for rogue activity and blocks malware attempts to infect your corporate network. Additionally, the L4 Traffic Monitor detects infected clients and stops malicious activity from going outside the corporate network.

For detailed information about the L4 Traffic Monitor, see [L4 Traffic Monitor, page 21-1](#).

## Administering the Web Security Appliance

You can manage the Web Security appliance using a web-based administration tool. When you first access the appliance, the web interface launches the System Setup Wizard to perform an initial configuration. After running the System Setup Wizard, you can use the web interface or Command Line Interface (CLI) to customize settings and maintain your configuration.

For a description of how to access the CLI and a list CLI supported commands, see [Command Line Interface, page 27-1](#).

### System Setup Wizard

The System Setup Wizard is a utility that configures basic settings and enables a set of system defaults. The System Setup Wizard is located on the System Administration tab. For more information about running the System Setup Wizard, see [System Setup Wizard, page 4-5](#).



#### Note

Running the System Setup Wizard completely reconfigures the Web Security appliance and resets the administrator password. Only use the System Setup Wizard the first time you install the appliance, or if you want to completely overwrite the existing configuration. Running the System Setup Wizard after the appliance is already configured can also interrupt client access to the web. If you choose to run the System Setup Wizard after performing an initial setup, use the System Administration > Configuration File pages to print a configuration summary and archive the current configuration file.

### Accessing the Web Security Appliance

To access the appliance and launch the web-based administration utility, open a web browser. For the list of supported web browsers, see [Browser Requirements, page 2-5](#).

Connect to the management interface using one of the following methods:

- IP address and port number

```
https://192.168.42.42:8443
```

-or-

```
http://192.168.42.42:8080
```

where 192.168.42.42 is the default IP address, and 8080 is the default admin port setting for HTTP, and 8443 is default admin port for HTTPS.

- Hostname and port number

```
https://hostname:8443
```

-or-

```
http://hostname:8080
```

where `hostname` is the name of the appliance, and 8080 is the default admin port setting for HTTP, and 8443 is default admin port for HTTPS.

**Note**

The hostname parameter is assigned during system setup. Before you can connect to the management interface using a hostname, you must add the appliance hostname and IP address to your DNS server database.

For information about how to use and navigate the web interface, see [Navigating the Web Security Appliance Web Interface, page 2-4](#).

## Using the Command Line Interface (CLI)

To administer the appliance using the CLI, you can use one of the following methods:

- **Ethernet connection.** Establish an SSH session using an Ethernet cable. For more information, see [Using an Ethernet Connection, page 2-3](#).
- **Serial connection.** Connect to the appliance COM port using a serial cable. For more information, see [Using a Serial Connection, page 2-3](#).

The Web Security appliance CLI supports a set of commands to access, install, and administer the system. See [Command Line Interface, page 27-1](#) for information about the CLI and a list of supported commands that can be used to access, upgrade, and administer the appliance.

## Using an Ethernet Connection

You can connect the appliance to the network using an Ethernet cable from the M1 Management port to the network, and then using an SSH session from a computer on the network to reach the appliance.

By default, the M1 Management port is assigned the IP address 192.168.42.42. To access the Management port, the personal computer must be assigned an IP address on the same subnet as the Management port, such as 192.168.42.43. The subnet mask is 255.255.255.0. This is the easiest way to connect if it works with your network configuration.

## Using a Serial Connection

You can connect directly to the appliance COM port using a null modem cable (9-pin serial) to establish a command line interface (CLI) session. You might want to do this if network connectivity to the appliance using an Ethernet cable is not an option.

To do this, you need the following items:

- 9-pin female-to-female serial cable (null modem)
- Serial console client (such as HyperTerminal or PuTTY)

The communications settings for the serial port are:

**Bits per second:** 9600

**Data bits:** 8

**Parity:** None

**Stop bits:** 1

**Flow control:** Hardware

## Reporting and Logging

The Web Security appliance provides several options for capturing data and monitoring system activity. For detailed information about scheduling reports, see [Reporting Overview, page 22-1](#). For more information about working with log files, see [Logging, page 24-1](#).

## Navigating the Web Security Appliance Web Interface

The Web Security appliance web interface is a web-based administration tool that allows you to configure and monitor the appliance. The web interface allows you to configure the appliance similar to the Command Line Interface (CLI). However, some features available in the web interface are not available in the CLI and vice versa. For more information about the CLI, see [Command Line Interface, page 27-1](#).

The Web Security appliance web interface contains multiple tabs where you can configure or monitor the appliance. You can set up Access Policies, schedule reports, enable features, and modify settings as necessary. The web interface also includes two menus from which you can perform basic administration tasks.

To use the web interface, open a web browser and log in. For more details, see [Accessing the Web Security Appliance, page 2-2](#). For a list of supported web browsers, see [Browser Requirements, page 2-5](#).

For a list of supported languages, see [Supported Languages, page 2-6](#).

The web interface contains the following menus:

- **Options.** From this menu, you can manage your user account. You can log out or change the password you use to log in to the web interface.
- **Help.** From this menu, you can access help from documentation or Cisco IronPort Customer Support. For Help tasks, you can access the online help or the Cisco IronPort Customer Support site. For Technical Support tasks, you can send a support request email to Cisco IronPort Customer Support or to allow Cisco IronPort Customer Support remote access to the Web Security appliance. For more information about the Technical Support tasks, see [Support Commands, page 26-2](#).

The web interface contains the following tabs:

- **Reporting.** Use the pages on this tab to view reports on the appliance by that display dynamic data on website activity and appliance activity and action. For more information, see [Reporting Tab, page 2-6](#).
- **Web Security Manager.** Use the pages on this tab to create and configure Access Policies that define which groups can access which types of websites. For more information, see [Web Security Manager Tab, page 2-7](#).
- **Security Services.** Use the pages on this tab to configure how the appliance monitors and secures the network. For more information, see [Security Services Tab, page 2-7](#).
- **Network.** Use the pages on this tab to define the network in which the appliance is located. For more information, see [Network Tab, page 2-8](#).
- **System Administration.** Use the pages on this tab to configure administrative options, such as users, alerts, system time, and more. You can also enter keys for features you enabled during initial setup. For more information, see [System Administration Tab, page 2-8](#).

Each tab has a list of menu selections from which you can choose. Each menu selection represents a different page in the web interface that further group information and activities. Some pages are grouped together into categories. You navigate among sections of the web interface by hovering the cursor over each tab heading and clicking a menu option from the menu that appears.

You open up other pages in the web interface by clicking on hypertext links and buttons. To find the various links, hover the cursor over text in the web interface. Links appear with an underline under the text when the cursor is over them.

When the documentation refers to specific pages in the web interface, it uses the tab name, following by an arrow and then the page name. For example, Web Security Manager > Access Policies.

## Logging In

All users accessing the web interface must log in. Type your username and password, and then click Login to access the web interface. You must use a supported web browser (see [Browser Requirements, page 2-5](#)). You can log in with the admin account or any other user account created in the appliance. For more information creating appliance users, see [Administering User Accounts, page 26-8](#).

After you log in, the Reporting > Overview page displays.

## Browser Requirements

To access the web interface, your browser must support and be enabled to accept JavaScript and cookies. It must be able to render HTML pages containing Cascading Style Sheets (CSS). For example, you can use the following browsers:

Browser	OS	Officially Supported?
Internet Explorer 9.0	Win 7	Yes
Internet Explorer 8.0	Win XP, Win 7	Yes
Internet Explorer 7.0	Win XP	Yes
Safari 4.0 and later	OS X	Yes
Firefox 10x and later	All	Yes
Firefox 4x-9x	All	Conditional**
Firefox 3.6x	All	Phase-out*
Google Chrome	All	Yes
Internet Explorer 6.0	Win XP	Phase-out*
Opera 10.0.x	Win XP	Conditional**
Safari 3.1	OS X	Phase-out*

\* Phase-out — Cisco will not address defects.

\*\* Conditional — Cisco will only address major, functional defects.

Your session automatically times out after 30 minutes of inactivity.

Some buttons and links in the web interface cause additional windows to open. Therefore, you may need to configure the browser's pop-up blocking settings in order to use the web interface.

**Note**

Only use one browser window or tab at a time to edit the appliance configuration. Also, do not edit the appliance using the web interface and the CLI at the same time. Editing the appliance from multiple places concurrently results in unexpected behavior and is not supported.

## Supported Languages

With the appropriate license key, AsyncOS can display its GUI and CLI in any of the following languages:

- English
- French
- Spanish
- German
- Italian
- Korean
- Japanese
- Portuguese (Brazil)
- Chinese (zh-cn and zh-tw)
- Russian

## Reporting Tab

Use the Reporting tab to monitor the appliance by viewing dynamic data on website activity and appliance activity and action.

The Reporting tab includes the following pages:

- Overview
- Users
- Web Sites
- URL Categories
- Application Visibility
- Anti-Malware
- Client Malware Risk
- Web Reputation Filters
- L4 Traffic Monitor
- Reports by User Location
- Web Tracking
- System Capacity
- System Status
- Scheduled Reports

- Archived Reports

## Web Security Manager Tab

Use the Web Security Manager tab to create and configure Access Policies that define which groups can access which types of websites.

The Web Security Manager tab includes the following pages:

- Identities
- SaaS Policies
- Decryption Policies
- Routing Policies
- Access Policies
- Overall Bandwidth Limits
- Cisco IronPort Data Security
- Outbound Malware Scanning
- External Data Loss Prevention
- Custom URL Categories
- Defined Time Ranges
- Bypass Settings
- L4 Traffic Monitor

## Security Services Tab

Use this tab to configure how the appliance monitors and secures the network.

The Security Services tab includes the following pages:

- Web Proxy
- FTP Proxy
- HTTPS Proxy
- PAC File Hosting
- Identity Provider for SaaS
- Acceptable Use Controls
- Anti-Malware
- Data Transfer Filters
- AnyConnect Secure Mobility
- Web Reputation Filters
- End-User Notification
- L4 Traffic Monitor
- SensorBase

## Network Tab

Use the Network tab to describe the network in which the appliance is located and to define the appliance's network settings.

The Network tab includes the following pages:

- Interfaces
- Transparent Redirection
- Routes
- Internal SMTP Relay
- Authentication
- Upstream Proxy
- External DLP Servers
- DNS

## System Administration Tab

Use the System Administration tab to configure administrative options, such as users, alerts, system time, and more. You can also enter keys for features you enabled during initial setup.

The System Administration tab includes the following pages:

- Policy Trace
- Users
- Alerts
- Log Subscriptions
- Return Addresses
- Time Zone
- Time Settings
- Configuration Summary
- Configuration File
- Feature Key Settings
- Feature Keys
- Upgrade and Update Settings
- System Upgrade
- System Setup Wizard
- Next Steps



# Committing and Clearing Changes

When you change the configuration of the Web Security appliance, you must commit the changes before they go into effect. Or, you can choose to clear the changes you have made if you do not want to commit them. How you commit and clear changes depends on the interface you use:

- Web interface
- Command Line Interface

When you commit some Web Security appliance configuration changes, the Web Proxy must restart for the changes to take effect. For more information, see [Checking for Web Proxy Restart on Commit](#), page 2-10.

## Committing and Clearing Changes in the Web Interface

Commit changes using the **Commit Changes** button in the upper right corner of the web interface. You can make multiple configuration changes before you commit all of them. When you make a change, the **Commit Changes** button color is yellow and the button text changes to “Commit Changes” as shown in [Figure 2-1](#).

**Figure 2-1**      *The Commit Button: Changes Pending*



When there are no changes to commit, the button color is gray and the button text is “No Changes Pending.” [Figure 2-2](#) shows the web interface when there are no changes to commit.

**Figure 2-2**      *The Commit Button: No Changes Pending*



You also use the **Commit Changes** button to clear the changes made since the last commit or clear.

## Committing Changes in the Web Interface

- 
- Step 1**      Click the **Commit Changes** button.
  - Step 2**      Enter comments in the Comment field if you choose.
  - Step 3**      Click **Commit Changes**.
- 

## Clearing Changes in the Web Interface

- 
- Step 1**      Click the **Commit Changes** button.
  - Step 2**      Click **Abandon Changes**.
-

## Committing and Clearing Changes in the CLI

Commit changes using the `commit` command. Most configuration changes you make in the Command Line Interface (CLI) are not effective until you issue the `commit` command. You may include comments up to 255 characters. Changes are not verified as committed until you receive confirmation along with a timestamp. The `commit` command applies configuration changes made to appliance since the last `commit` or `clear` command issued.

For more information about using the `commit` command, see [Committing Configuration Changes, page 27-5](#).

Clear changes using the `clear` command. For more information about using the `clear` command, see [Clearing Configuration Changes, page 27-5](#).

## Checking for Web Proxy Restart on Commit

Some configuration changes you make to the Web Security appliance trigger a Web Proxy restart when you commit the changes. When the Web Proxy restarts, the Web Security appliance allows web traffic to continue but there is a brief interruption of Web Proxy services, such as anti-malware scanning. Typically, the Web Proxy uses less than 30 seconds to restart due to a configuration change. (If the Web Proxy restarts due to an internal error, the entire restart process may take a few minutes to start all services on the appliance.)

To minimize the security risk from web traffic that goes unscanned, you can determine if your configuration changes will trigger a Web Proxy restart before you commit them. You can then schedule to commit your configuration changes for a time when the Web Proxy processes fewer user transactions, such as overnight. How you check for this depends on the interface:

- **Web interface.** When you click the **Commit Changes** button, the web interface displays a warning on the Uncommitted Changes page that the Web Proxy will restart as a result of the commit.
- **CLI.** Use the `checkproxyrestart` command before the `commit` command. If the configuration changes require a Web Proxy restart, the CLI displays “The changes will trigger a proxy restart.”

In addition to a brief interruption of Web Proxy services, you may notice the following effects when the Web Proxy restarts:

- The authentication cache is cleared and users need to be authenticated again.
- Tracking statistics are reset. This also affects SNMP because the values depend on tracking statistics.
- The Web Proxy DNS cache is cleared.
- The HTTPS certificate cache is cleared.
- Connections to authentication servers are renegotiated.
- Any data in the Web Proxy cache that was not written to disk is lost.
- Any logging data that is not written to a log file is lost.

# Participating in The Cisco SensorBase Network

The Cisco SensorBase Network is a threat management database that tracks millions of domains around the world and maintains a global watch list for Internet traffic. SensorBase provides Cisco with an assessment of reliability for known Internet domains. The Web Security appliance uses the SensorBase data feeds to improve the accuracy of Web Reputation Scores.

Standard SensorBase Network Participation is enabled by default during system setup. You can edit the participation level and other settings on the Security Services > SensorBase page after system setup.

- 
- Step 1** Navigate to the Security Services > SensorBase page.
- Step 2** Verify that SensorBase Network Participation is enabled.
- When it is disabled, none of the data that the appliance collects is sent back to the SensorBase Network servers.
- Step 3** In the Participation Level section, choose one of the following levels:
- **Limited.** Basic participation summarizes server name information and sends MD5-hashed path segments to the SensorBase Network servers.
  - **Standard.** Enhanced participation sends the entire URL with unobfuscated path segments to the SensorBase Network servers. This option assists in providing a more robust database, and continually improves the integrity of Web Reputation Scores.
- Step 4** In the AnyConnect Network Participation field, choose whether or not to include information collected from clients that connect to the Web Security appliance using Cisco AnyConnect Client.
- AnyConnect Clients send their web traffic to the appliance using the Secure Mobility feature. For more information, see [Achieving Secure Mobility, page 14-1](#).
- Step 5** In the Excluded Domains and IP Addresses field, optionally enter any domains or IP addresses to exclude from traffic sent to the SensorBase servers.
- Step 6** Submit and commit your changes.
- 

## Sharing Data

Participating in the Cisco SensorBase Network means that Cisco collects data and shares that information with the SensorBase threat management database. This data includes information about request attributes and how the appliance handles requests.

Cisco recognizes the importance of maintaining your privacy, and does not collect or use personal or confidential information such as usernames and passwords. Additionally, the file names and URL attributes that follow the hostname are obfuscated to ensure confidentiality. When it comes to decrypted HTTPS transactions, the SensorBase Network only receives the IP address, web reputation score, and URL category of the server name in the certificate.

If you agree to participate in the SensorBase Network, data sent from your appliance is transferred securely using HTTPS. Sharing data improves Cisco's ability to react to web-based threats and protect your corporate environment from malicious activity.



# 3

## Deployment

---

- [Deployment Overview, page 3-1](#)
- [Appliance Interfaces, page 3-2](#)
- [Deploying the Web Proxy in Explicit Forward Mode, page 3-4](#)
- [Deploying the Web Proxy in Transparent Mode, page 3-5](#)
- [Connecting the Appliance to a WCCP Router, page 3-6](#)
- [Using the Web Security Appliance in an Existing Proxy Environment, page 3-10](#)
- [Deploying the L4 Traffic Monitor, page 3-11](#)
- [, page 3-13](#)

## Deployment Overview

The Web Security appliance is typically installed as an additional layer in the network between clients and the Internet. Depending on how you deploy the appliance, you may or may not need a Layer 4 (L4) switch or a WCCP router to direct client traffic to the appliance.

When you deploy the Web Security appliance, you can enable one or both of the following features:

- **Secure web proxy.** The appliance web proxy service monitors and scans web traffic for malicious content. When you enable the web proxy, you can configure it to be in transparent or explicit forward mode.
- **L4 Traffic Monitor.** The L4 Traffic Monitor detects and blocks rogue traffic across all ports and IP addresses. The L4 Traffic Monitor listens to network traffic that comes in over all ports and IP addresses on the appliance and matches domain names and IP addresses against entries in its own database tables to determine whether to allow outgoing traffic.

By default, both the L4 Traffic Monitor and Web Proxy are enabled in the System Setup Wizard. If you need to disable both or one of these features, you can do so after initial setup from the web interface.

The features you enable determine how you deploy and physically connect the appliance to the network. For more information about how the features you enable affect appliance deployment, see [Preparing for Deployment, page 3-1](#). For more information about the Ethernet ports used to physically connect the appliance to the network, see [Appliance Interfaces, page 3-2](#).

## Preparing for Deployment

Before installing the Web Security appliance, read through the following questions and use the responses to each question to help you decide how to deploy the appliance and where to locate it in your network. Each response includes a reference to a different section that covers the response in more detail.

1. Will you deploy the Web Security appliance as a transparent proxy or an explicit forward proxy?

- **Explicit Forward Proxy.** Client applications, such as web browsers, are aware of the Web Proxy and must be configured to point to a single Web Security appliance. This deployment requires a connection to a standard network switch. When you deploy the Web Proxy in explicit forward mode, you can place it anywhere in the network. For more information, see [Deploying the Web Proxy in Explicit Forward Mode, page 3-4](#).
- **Transparent Proxy.** Clients applications are unaware of the Web Proxy and do not have to be configured to connect to the proxy. This deployment requires an Layer 4 switch or a WCCP v2 router. For more information, see [Deploying the Web Proxy in Transparent Mode, page 3-5](#).



---

**Note** A Layer 4 switch is a switch capable of doing policy based routing.

---

2. Does the network have an existing proxy?

If yes, it is recommended you deploy the Web Security appliance downstream from an existing proxy server, meaning closer to the clients. The System Setup Wizard refers to this as an upstream proxy configuration.

For more information, see [Using the Web Security Appliance in an Existing Proxy Environment, page 3-10](#).

3. Will you enable the L4 Traffic Monitor?

L4 Traffic Monitor deployment is independent of the Web Proxy deployment. You can connect the L4 Traffic Monitor to a network tap or the mirror/span port of a switch.

For more information, see [Deploying the L4 Traffic Monitor, page 3-11](#).

## Appliance Interfaces

The Web Security appliance includes six physical Ethernet ports on the back of the system. Each Ethernet port corresponds to a different network interface. The Ethernet ports are grouped into the following types of network interfaces:

- **Management.** The Management interfaces include M1 and M2. However, only the M1 interface is enabled on the appliance. For more information, see [Management Interface, page 3-3](#).
- **Data.** The Data interfaces include P1 and P2. Use the Data interfaces for Web Proxy data traffic. For more information, see [Data Interfaces, page 3-3](#).
- **L4 Traffic Monitor.** The L4 Traffic Monitor interfaces include T1 and T2. Use these interfaces for monitoring and blocking L4 Traffic Monitor traffic. For more information, see [L4 Traffic Monitor Interfaces, page 3-3](#).

[Figure 3-1](#) shows the Ethernet ports on the back of the Web Security appliance blade.

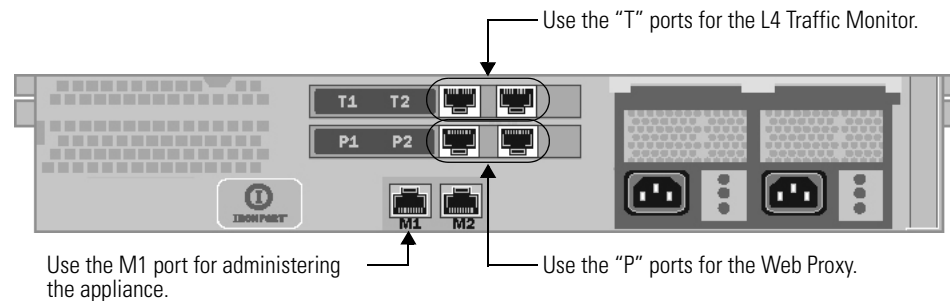
**Figure 3-1 Web Security Appliance Ethernet Ports**

## Management Interface

Use M1 to administer the appliance. Optionally, you can also configure the M1 interface to handle Web Proxy data traffic. You might want to use the M1 interface for data traffic if your organization does not use a separate management network.

For more information about using the M1 port to set up and manage the appliance, see [Connecting a Laptop to the Appliance, page 4-1](#).

For more information about configuring the network interfaces, see [Configuring Network Interfaces, page 25-2](#).

## Data Interfaces

The appliance uses the Data interfaces for Web Proxy data traffic. You can enable and use just the P1 port or both the P1 and P2 ports for data traffic.

- **P1 only enabled.** When only P1 is enabled, connect it to the network for both incoming and outgoing traffic.
- **P1 and P2 enabled.** When both P1 and P2 are enabled, you must connect each interface to a different subnet. Typically, P1 is connected to the internal network and P2 toward the Internet. Note, however, that the appliance cannot be supported in inline mode.



### Note

You can only enable and configure the P1 interface for data traffic in the System Setup Wizard. If you want to enable the P2 interface, you must do so after system setup in the web interface or using the `ifconfig` command. For more information about configuring the P2 interface, see [Configuring Network Interfaces, page 25-2](#).

How you physically connect the data interfaces to the network depends on how you deploy the appliance. For more information, see [Deploying the Web Proxy in Explicit Forward Mode, page 3-4](#) and [Deploying the Web Proxy in Transparent Mode, page 3-5](#).

## L4 Traffic Monitor Interfaces

The appliance uses the T1 and T2 interfaces for listening to traffic on all TCP ports. You can connect just T1 or both T1 and T2 using an Ethernet cable, depending on whether you use simplex or duplex communication.

- **T1 only connected (duplex).** When you configure the appliance to use duplex communication, connect T1 to the network so it receives all incoming and outgoing traffic.
- **T1 and T2 connected (simplex).** When you configure the appliance to use simplex communication, connect T1 to the network so it receives all outgoing traffic (from the clients to the Internet), and connect T2 to the network so it receives all incoming traffic (from the Internet to the clients).

For more information about how to connect the L4 Traffic Monitor ports to the network, see [Deploying the L4 Traffic Monitor, page 3-11](#).

## Example Deployment

Figure 3-2 on page 3-4 shows a sample deployment scenario with both the Web Proxy and L4 Traffic Monitor enabled. In this example, the Web Proxy is deployed in transparent mode and only the P1 port is connected to either a Layer 4 switch or a WCCP router.

**Figure 3-2** Web Security Appliance Deployment Scenario

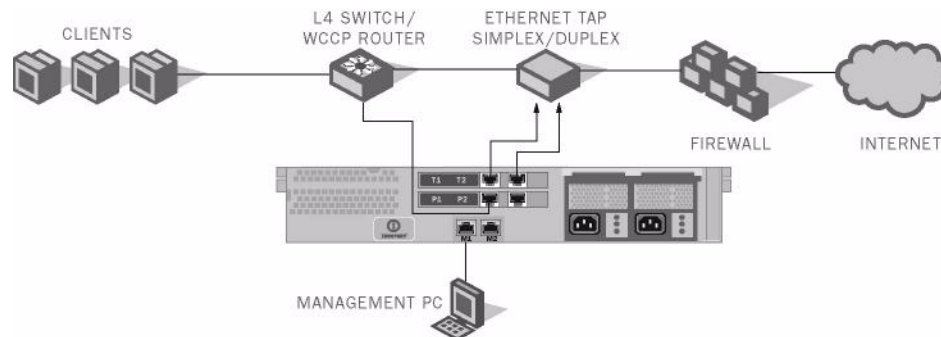

## Deploying the Web Proxy in Explicit Forward Mode

When the appliance is configured as an explicit forward proxy, client applications must be configured to direct its traffic to the appliance. When you want to configure the Web Proxy in explicit forward mode, you must configure the following components:

- Client applications
- Appliance ports



### Tip

If your organization needs to use explicit forward mode now, but might need transparent mode in the future, consider deploying the Web Proxy in transparent mode and then choosing Layer 4 switch as the connection type. If you do not have an Layer 4 switch, you can connect the appliance to the network normally and the appliance will work in explicit forward mode. When the Web Proxy is deployed in transparent mode, it can accept both transparently redirected and explicitly forwarded transactions. To use transparent mode in the future, you can connect the appliance to an Layer 4 switch and it will work in transparent mode without needing to change the Web Proxy mode later. However, it is easy to change the deployment mode at any time on the Security Services > Web Proxy page.



## Configuring Client Applications

You must configure all client applications, such as web browsers and FTP clients, used on the network to point to the Web Proxy. You can configure each client in the following ways:

- **Manual.** Configure each client application to point the appliance Web Proxy by specifying the appliance hostname or IP address and the port number, such as 3128, used for listening to data traffic.
- **Automatic.** Configure each client application to use a PAC file to detect the appliance Web Proxy automatically. Then you can edit the PAC file to specify the appliance Web Proxy information. PAC files work with web browsers only. For more information, see [Working with PAC Files, page 5-14](#).

## Connecting Appliance Interfaces

You can connect the P1 interface or both the P1 and P2 interfaces to a network switch using an Ethernet cable. You do not need special hardware, such as a particular switch or router. For more information about how to connect the data interfaces (P1 and P2), see [Data Interfaces, page 3-3](#).

## Testing an Explicit Forward Configuration

If you want to test an explicit forward proxy configuration, you can separate and forward traffic from a subset of your network infrastructure. To individually test this configuration, clients can forward traffic to the appliance from one web browser and connect to the Internet using another web browser. This method also ensures an alternate path to the Internet while testing.

## Deploying the Web Proxy in Transparent Mode

When the appliance is configured as a transparent proxy, client applications are not aware that their traffic gets redirected to the appliance, and they do not need to be configured to point to the appliance. To deploy the appliance in this mode, you need one of the following types of hardware to transparently redirect web traffic to the appliance:

- **WCCP v2 router.** When you specify a WCCP router, you need to configure additional settings on the appliance. For more information about using the appliance with a WCCP router, see [Connecting the Appliance to a WCCP Router, page 3-6](#).
- **Layer 4 switch.** When you specify an Layer 4 switch, you only need to specify that the appliance is connected to a Layer 4 switch when you configure the appliance. You do not need to configure anything else on the appliance.

Typically, you configure the appliance to use an Layer 4 switch or a WCCP v2 router during initial system setup. However, you can configure it to use either an Layer 4 switch or a WCCP v2 router anytime after initial setup on the Network > Transparent Redirection page. For more information about the Network > Transparent Redirection page, see [Configuring Transparent Redirection, page 25-11](#).

**Note**

When the Web Proxy is configured in transparent mode, you must enable the HTTPS Proxy if the appliance receives HTTPS traffic. When the HTTPS Proxy is disabled, the Web Proxy passes through explicit HTTPS connections and it drops transparently redirected HTTPS requests. The access logs contain the CONNECT requests for explicit HTTPS connections, but no entries exist for dropped transparently redirected HTTPS requests.

## Connecting Appliance Interfaces

When you configure the Web Proxy in transparent mode, you can connect the P1 port or both the P1 and P2 ports to an Layer 4 switch or WCCP router using an Ethernet cable. For more information about how to connect the data interfaces (P1 and P2), see [Data Interfaces, page 3-3](#).

## Connecting the Appliance to a WCCP Router

When you connect the appliance to a WCCP router, you must perform the following tasks:

1. You must create at least one WCCP service on the appliance. For more information, see [Configuring the Web Security Appliance, page 3-6](#).
2. After you create a WCCP service, you must configure the router to work with the Web Security appliance. For more information, see [Configuring the WCCP Router, page 3-6](#).

You can also connect an appliance to multiple WCCP routers. For more information, see [Working with Multiple Appliances and Routers, page 3-10](#).

## Configuring the Web Security Appliance

A WCCP service is an appliance configuration that defines a service group to a WCCP v2 router. It includes information such as the service ID and ports used. Service groups allow a web proxy to establish connectivity with a WCCP router and to handle redirected traffic from the router.

Create WCCP services on the Network > Transparent Redirection page. The WCCP services you create determine how you configure the WCCP routers. For more information about creating WCCP services, see [Adding and Editing a WCCP Service, page 25-14](#).

**Note**

You can enable the standard service (also known as the “web-cache” service) during system setup, and you can configure different or additional WCCP service groups after you run the System Setup Wizard.

## Configuring the WCCP Router

After you create at least one WCCP service in the Web Security appliance, you can configure the WCCP router(s) in the network.

Use the following syntax for enabling WCCP on the router:

```
ip wccp version 2
ip wccp service_group
interface interface_type_number
ip wccp service_group redirect direction
ip wccp service_group password password
```

Enter one of the following values for the *service\_group* variable:

- **web-cache.** Enter “web-cache” when the appliance WCCP service uses the standard service.
- **Service ID number.** Enter a number from 0 to 255 when the appliance WCCP service uses a dynamic service ID. The number should match the service ID number used in the appliance.

Table 3-1 describes each part of the WCCP configuration syntax for enabling WCCP on the router.

**Table 3-1 WCCP Router Configuration Syntax for Enabling the Router**

WCCP Configuration	Description
<code>ip wccp version 2</code>	Defines the version of WCCP to use on the router. You must specify version 2 to work with the Web Security appliance. This command is required.
<code>ip wccp service_group password password</code>	Specifies a service group to enable on the router. It also enables the WCCP service on the router. This command is required.
<code>interface interface_type_number</code>	Specifies an interface to configure and enters interface configuration mode. Enter the interface number for the <i>interface_type_number</i> variable. This command is required.
<code>ip wccp service_group redirect direction</code>	Enables WCCP redirection on the specified interface. Enter one of the following values for the <i>direction</i> variable: <ul style="list-style-type: none"> <li>• <b>in.</b> Use <code>in</code> when you want the router to redirect packets as they enter the router.</li> <li>• <b>out.</b> Use <code>out</code> when you want the router to redirect packets right before they leave the router.</li> </ul> This command is required.
<code>ip wccp service_group password password</code>	Sets a password on the router for the specified service group. This command is only required when the WCCP service defined on the appliance has password security enabled.

You can also configure a WCCP router to perform other tasks, such as the following:

- Configure the router from exclude redirecting traffic received on a particular interface.
- If the network uses multiple Web Security appliances, you can configure the router to determine which traffic should be directed to which appliance by using an access list. You might want to redirect only some of the network traffic to the appliance if you are evaluating the Web Security appliance.

**Note**

The Web Security appliance does not support using a multicast address in the WCCP service group. To use multiple routers in a service group, you must specify the IP address of each router in the service group and configure each router separately. You cannot register a router to a multicast address.

## Example WCCP Configurations

This section shows some sample WCCP services defined in the appliance and the corresponding WCCP configuration you should use to configure the router that connects to the appliance.

### Example 1

Suppose you have the WCCP service shown in [Figure 3-3](#).

**Figure 3-3 Example WCCP Service — Standard Service, No Password Required**

#### Add WCCP v2 Service

WCCP v2 Service	
Service Profile Name:	web_cache
Service:	<input checked="" type="radio"/> Standard service ID: 0 web-cache (destination port 80) <input type="radio"/> Dynamic service ID: 0 0-255 Port numbers: 80 <small>(up to 8 port numbers, separated by commas)</small> <input checked="" type="radio"/> Redirect based on destination port <input type="radio"/> Redirect based on source port (return path) <small>For IP spoofing, define two services, one based on destination port and another based on source port (return path).</small> <input type="radio"/> Load balance based on server address <input type="radio"/> Load balance based on client address <small>Applies only if more than one Web Security Appliance is in use.</small>
Router IP Addresses:	10.1.1.1 <small>Separate multiple entries with line breaks or commas.</small>
Router Security:	<input type="checkbox"/> Enable Security for Service Password: <input type="text"/> Confirm Password: <input type="text"/>
Advanced:	Load-Balancing Method: <input type="text" value="Allow Hash or Mask"/> Forwarding Method: <input type="text" value="Allow GRE or L2"/> Return Method: <input type="text" value="Allow GRE or L2"/>

In this example, the WCCP service defines the standard service group (also known as a well known service group). The redirection basis is on the destination port by default. Also suppose in this example that you want to configure the ethernet1 interface on the router for this service group.

Use the following WCCP configuration for this example:

```
ip wccp version 2
ip wccp web-cache
interface ethernet1
ip wccp web-cache redirect in
```

## Example 2

Figure 3-4 shows a dynamic service you might create when IP spoofing is enabled and the WCCP service shown in Figure 3-3 on page 3-8 is defined.

**Figure 3-4 Example WCCP Service – Dynamic Service for IP Spoofing**

### Add WCCP v2 Service

WCCP v2 Service	
Service Profile Name:	return_web
Service:	<input type="radio"/> Standard service ID: 0 web-cache (destination port 80) <input checked="" type="radio"/> Dynamic service ID: 90 0-255 Port numbers: <input type="text" value="90 0-255"/> <small>(up to 8 port numbers, separated by commas)</small> <input type="radio"/> Redirect based on destination port <input checked="" type="radio"/> Redirect based on source port (return path) <small>For IP spoofing, define two services, one based on destination port and another based on source port (return path).</small> <input checked="" type="radio"/> Load balance based on server address <input type="radio"/> Load balance based on client address <small>Applies only if more than one Web Security Appliance is in use.</small>
Router IP Addresses:	10.1.1.1 <small>Separate multiple entries with line breaks or commas.</small>
Router Security:	<input type="checkbox"/> Enable Security for Service Password: <input type="text"/> Confirm Password: <input type="text"/>
Advanced:	Load-Balancing Method: <input type="text" value="Allow Hash or Mask"/> Forwarding Method: <input type="text" value="Allow GRE or L2"/> Return Method: <input type="text" value="Allow GRE or L2"/>

In this example, the WCCP service defines a dynamic service group with service ID of 90. The redirection basis is on the source port so it can be used for the return path with IP spoofing enabled. Suppose in this example that you want to configure the ethernet0 interface on the router for this service group.

Use the following WCCP configuration for this example:

```
ip wccp version 2
ip wccp 90
interface ethernet0
ip wccp 90 redirect in
```

For more information about enabling IP spoofing when using a WCCP router, see [IP Spoofing when Using WCCP, page 25-13](#).

## Example 3

Suppose you have the WCCP service shown in Figure 3-5.

Figure 3-5 Example WCCP Service — Dynamic Service, Password Required

## Add WCCP v2 Service

WCCP v2 Service	
Service Profile Name:	service80_443
Service:	<input type="radio"/> Standard service ID: 0 web-cache (destination port 80) <input checked="" type="radio"/> Dynamic service ID: 120 0-255 Port numbers: 80, 443 <small>(up to 8 port numbers, separated by commas)</small> <input checked="" type="radio"/> Redirect based on destination port <input type="radio"/> Redirect based on source port (return path) <small>For IP spoofing, define two services, one based on destination port and another based on source port (return path).</small> <input checked="" type="radio"/> Load balance based on server address <input type="radio"/> Load balance based on client address <small>Applies only if more than one Web Security Appliance is in use.</small>
Router IP Addresses:	10.1.1.1, 10.5.5.5 <small>Separate multiple entries with line breaks or commas.</small>
Router Security:	<input checked="" type="checkbox"/> Enable Security for Service Password: <input type="password" value="*****"/> Confirm Password: <input type="password" value="*****"/>
Advanced:	Load-Balancing Method: <input type="text" value="Allow Hash or Mask"/> Forwarding Method: <input type="text" value="Allow GRE or L2"/> Return Method: <input type="text" value="Allow GRE or L2"/>

In this example, the WCCP service defines a dynamic service group with service ID of 120. The redirection basis is on the destination port, and it has enabled a password for this service group of “admin99” (hidden in the appliance configuration). Also suppose in this example that you want to configure the ethernet0 interface on the router for this service group.

Use the following WCCP configuration for this example:

```
ip wccp version 2
ip wccp 120
interface ethernet0
ip wccp 120 redirect in
ip wccp 120 password admin99
```

## Working with Multiple Appliances and Routers

When you connect one or more Web Security appliances to one or more WCCP routers, you have a cluster. You can include up to 32 appliances and up to 32 routers in a cluster. You must configure all appliances and routers in a cluster to communicate with each other.

## Using the Web Security Appliance in an Existing Proxy Environment

The Web Security appliance is a proxy-compatible device, and is easily deployed within an existing proxy environment. However, it is recommended that you place the appliance downstream from existing proxy servers, meaning closer to the clients.

You can configure the appliance to work with an existing, upstream proxy in the System Setup Wizard or after the initial setup in the web interface. Use the Network > Upstream Proxies page to enable an upstream proxy or to modify existing settings.

When configuring an upstream proxy, you specify whether the existing proxy is in transparent or explicit forward mode.

## Transparent Upstream Proxy

If a transparent upstream proxy uses client IP addresses to manage user authentication and access control, you must enable IP spoofing on the Web Security appliance to send client IP addresses to the upstream proxy. Use the Security Services > Web Proxy page to enable IP spoofing.

When you enable IP spoofing and connect the appliance to a WCCP router, you must create at least two WCCP services. For more information about configuring WCCP services when you enable IP spoofing, see [IP Spoofing when Using WCCP, page 25-13](#).

## Explicit Forward Upstream Proxy

If the upstream proxy is in explicit forward mode, consider the following rules and guidelines:

- You must enter the IP address or hostname and port of the upstream proxy.
- Consider whether the hostname of the upstream proxy resolves to multiple IP addresses. The Web Security appliance only queries the DNS server for the IP address at startup. If an IP address is added or removed from that hostname, the proxy must restart to resolve and add the hostname to the new set of IP addresses.
- If the upstream proxy manages user authentication or access control using proxy authentication, you must enable the X-Forwarded-For header to send the client host header to the upstream proxy. Use the Security Services > Web Proxy page to enable the X-Forwarded-For header setting.
- If you want to send authentication credentials to an upstream proxy when the Web Security appliance is deployed in explicit forward mode, you must configure the Web Proxy to forward authorization request headers to a parent proxy server using the `advancedproxyconfig > authentication` CLI command.



---

**Note** By default, the Web Proxy does not forward proxy authorization headers to upstream proxy servers for security reasons.

---

- If the upstream proxy manages client traffic using a PAC file or a login script, you must update these files to use the IP address or hostname of the Web Security appliance.

## Deploying the L4 Traffic Monitor

L4 Traffic Monitor (L4TM) deployment is independent of the Web Proxy deployment. When connecting and deploying the L4 Traffic Monitor, consider the following:

- **Physical connection.** You can choose how to connect the L4 Traffic Monitor to the network. For more information, see [Connecting the L4 Traffic Monitor, page 3-12](#).

- **Network address translation (NAT).** When configuring the L4 Traffic Monitor, connect it at a point in your network where it can see as much network traffic as possible before getting out of your egress firewall and onto the Internet. It is important that the L4 Traffic Monitor be ‘logically’ connected after the proxy ports and before any device that performs network address translation (NAT) on client IP addresses.
- **L4 Traffic Monitor action setting.** The default setting for the L4 Traffic Monitor is monitor only. After setup, if you configure the L4 Traffic Monitor to monitor and block suspicious traffic, ensure that the L4 Traffic Monitor and the Web Proxy are configured on the same network so that all clients are accessible on routes that are configured for data traffic.

## Connecting the L4 Traffic Monitor

You can connect the L4 Traffic Monitor to the network in any of the following ways:

- **Network tap.** When you use a network tap, you can choose the following communication types:
  - **Simplex.** This communication type uses one cable for all traffic between clients and the appliance, and one cable for all traffic between the appliance and external connections. Connect port T1 to the network tap so it receives all outgoing traffic (from the clients to the Internet), and connect port T2 to the network tap so it receives all incoming traffic (from the Internet to the clients).
  - **Duplex.** This mode uses one cable for all incoming and outgoing traffic. You can use half- or full-duplex Ethernet connections. Connect port T1 to the network tap so it receives all incoming and outgoing traffic.



---

**Note** Cisco recommends using simplex when possible because it can increase performance and security.

---

- **Span/mirror port of an L2 switch.** Connecting is similar to a simplex or duplex tap, depending on whether the connection uses two separate devices or one device.
- **Hub.** Choose duplex when you connect the L4 Traffic Monitor to a hub.

Regardless of how the appliance is connected to the network, you must configure the wiring type. For more information, see [Configuring an L4 Traffic Monitor Wiring Type, page 3-12](#).

For more information about the T1 and T2 ports, see [Appliance Interfaces, page 3-2](#).



---

**Note** Use a network tap instead of the span/mirror port of a switch when possible. Network taps use hardware to move packets to the L4 Traffic Monitor and span and mirror ports of a switch use software to move packets. Hardware solutions move packets with better performance than software solutions and are less likely to drop packets in the process.

---

## Configuring an L4 Traffic Monitor Wiring Type

Typically, the L4 Traffic Monitor wiring type is configured during system setup. However, you can configure the wiring type after running the System Setup Wizard on the Network > Interfaces page. Click **Edit Settings** and select a wiring type for the T1 and T2 ports.



**Figure 3-6** L4 Traffic Monitor Wiring Types

L4 Traffic Monitor	
L4 Traffic Monitor Wiring:	<input checked="" type="radio"/> Duplex TAP: T1 (In/Out) <input type="radio"/> Simplex TAP: T1 (In) and T2 (Out)



# 4

## Installation and Configuration

---

- [Before You Begin, page 4-1](#)
- [System Setup Wizard, page 4-5](#)

### Before You Begin

To use the Web Security appliance, you must run the System Setup Wizard. However, first you must do some steps to prepare the appliance for the System Setup Wizard.

If you are configuring a virtual Web Security appliance, please see the *Cisco Virtual Security Appliance Installation Guide* before continuing with this chapter.

For more information about preparing the appliance for installation, see the Web Security appliance *QuickStart Guide*. You can find this guide and other useful information about the Web Security appliance on the Cisco IronPort Customer Support site:

<http://www.cisco.com/web/ironport/index.html>

Complete the following tasks before you run the System Setup Wizard:

- **Deployment.** Decide how you are going to configure the appliance within your network. For details, see [Deployment, page 3-1](#).
- **Laptop network connection.** Configure your laptop's network connection to use an IP address on the same subnet as the Web Security appliance (192.168.42.xx). For details, see [Connecting a Laptop to the Appliance, page 4-1](#).
- **Appliance physical connections.** Plug the Ethernet cables into the appropriate ports on the back panel of the appliance. For details, see [Connecting the Appliance to the Network, page 4-2](#).
- **Setup information.** Once you know how you will install the appliance in your network, gather all the information, such as IP addresses, necessary for the System Setup Wizard. For details, see [Gathering Setup Information, page 4-3](#).
- **Existing proxy server.** If you plan to use the Web Security appliance in a network that has an existing proxy server, you must locate it downstream from other proxy servers. Also, after you finish the initial setup of the appliance, you must configure it to work with the existing proxy server. For more information about deploying the appliance in a network with an existing proxy, see [Using the Web Security Appliance in an Existing Proxy Environment, page 3-10](#).

### Connecting a Laptop to the Appliance

In order to run the System Setup Wizard the first time, you must connect a computer, such as a laptop, to the appliance. To connect to the appliance, the laptop subnet must be the same as the appliance subnet. The Management ports are labeled M1 and M2. The Web Security appliance only uses the M1 Management port. It does not use M2.

Configure the laptop IP address so it is on the same subnet as the appliance (192.168.42.xx). Then, connect the laptop to the M1 port on the back of the appliance.

## Connecting the Appliance to the Network

You must plug the Ethernet cables into the appropriate ports on the back panel of the appliance. For more information about the Ethernet ports on the appliance, see [Appliance Interfaces, page 3-2](#).

How you deploy the appliance determines which Ethernet cables to plug in where:

- **Web proxy in transparent mode.** If you want to use one proxy port for all traffic, connect port P1 to an Layer 4 switch or a WCCP router using an Ethernet cable. If you want to use two proxy ports for traffic, connect port P2 to an Layer 4 switch or a WCCP router using an Ethernet cable, and connect port P1 to the internal network.

For more information about deploying the Web Proxy in transparent mode, see [Deploying the Web Proxy in Transparent Mode, page 3-5](#).



---

**Note** When you configure the proxy in transparent mode and connect it to a WCCP router, you must configure the appliance after you run the System Setup Wizard to create at least one WCCP service. For more information about creating WCCP services, see [Adding and Editing a WCCP Service, page 25-14](#).

---

- **Web proxy in explicit forward mode.** If you want to use one proxy port for all traffic, connect port P1 to a network switch using an Ethernet cable. If you want to use two proxy ports for traffic, connect port P2 to a network switch using an Ethernet cable, and connect port P1 to the internal network.

For more information about deploying the Web Proxy in explicit forward mode, see [Deploying the Web Proxy in Explicit Forward Mode, page 3-4](#).

- **L4 Traffic Monitor.** Connect the Traffic Monitor ports to the Ethernet tap according to the tap communication type:
  - **Ethernet tap using simplex.** Connect port T1 to the Ethernet tap so it receives all outgoing traffic (from the clients to the Internet), and connect port T2 to the Ethernet tap so it receives all incoming traffic (from the Internet to the clients).
  - **Ethernet tap using duplex.** Connect port T1 to the Ethernet tap so it receives all incoming and outgoing traffic.

For more information about deploying the L4 Traffic Monitor, see [Deploying the L4 Traffic Monitor, page 3-11](#).

## Gathering Setup Information

Once you know how you will install the appliance in your network, you can gather the necessary information, such as IP addresses, to enter in the System Setup Wizard. You can use the worksheet in [Table 4-1](#) to write down the configuration options you decide on. Then, when you run the System Setup Wizard, you can use the information you enter in the worksheet to configure the initial setup.

**Table 4-1 System Setup Worksheet**

<b>Network Settings</b>	
Default System Hostname:	See <a href="#">DNS Support, page 4-4</a> for more information.
DNS Servers:	Internet root DNS servers / organization DNS servers
Organization DNS Servers: (maximum 3)	1. 2. 3.
Network Time Protocol Server:	
Time Zone Region:	
Time Zone Country:	
Time Zone / GMT Offset:	
<b>Network Context</b>	
Is there another proxy on the network:	Yes / No
Other Proxy IP Address:	
Other Proxy Port:	
<b>Interface Settings</b>	
<b>Management Port</b>	
IP Address:	
Network Mask:	
Hostname:	
<b>Data Port</b>	
IP Address:	
Network Mask:	
Hostname:	
<b>Note:</b> The Web Proxy can share the Management interface. If configured separately, the Data interface IP address and the Management interface IP address cannot share the same subnet.	
<b>L4 Traffic Monitor</b>	
L4 Traffic Monitor Wiring Type:	Simplex network tap / Duplex network tap
<b>Routes</b>	
<b>Management Traffic</b>	
Default Gateway:	

Table 4-1 System Setup Worksheet (continued)

Static Route Table Name:	
Static Route Table Destination Network:	
Static Route Table Gateway:	
<b>Data Traffic</b>	
Default Gateway:	
Static Route Table Name:	
Static Route Table Destination Network:	
Static Route Table Gateway:	
<b>Transparent Connection Settings</b>	
Device Type:	Layer 4 switch or No Device / WCCP Router
If WCCP v2 Router, enable standard service:	Yes / No
Standard Service Router Addresses:	
Enable Router Security?	No / Yes, password: _____
<b>Note:</b> When you connect the appliance to a WCCP router, you might need to configure the Web Security appliance to create WCCP services after you run the System Setup Wizard. For more information about creating WCCP services, see <a href="#">Adding and Editing a WCCP Service, page 25-14</a> .	
<b>Administrative Settings</b>	
Administrator Password:	
Email System Alerts To:	
SMTP Relay Host:	(optional)
AutoSupport:	Enable / Disable
SensorBase Network Participation:	Enable / Disable
Participation Level:	Limited / Standard
<b>Security Services</b>	
Global Policy Default Action:	Monitor all traffic / Block all traffic
L4 Traffic Monitor:	Monitor only / Block
Acceptable Use Controls:	Enable / Disable
Reputation Filtering:	Enable / Disable
Malware and Spyware Scanning:	Enable Webroot / Enable McAfee / Enable both
Action for Detected Malware:	Monitor only / Block
Cisco IronPort Data Security Filtering:	Enable / Disable

## DNS Support

To connect to the management interface using a hostname (http://hostname:8080), you must add the appliance hostname and IP address to your DNS server database.

## Loading the License for a Virtual Appliance

If you are setting up a virtual Web Security appliance, you will have to use the `loadlicense` command to load your virtual appliance license before running the System Setup Wizard. See the *Cisco Virtual Security Appliance Installation Guide* for more information.

## System Setup Wizard

The Cisco IronPort AsyncOS for Web operating system provides a browser-based wizard to guide you through initial system configuration. This System Setup Wizard prompts you for basic initial configuration, such as network configuration and security settings. The System Setup Wizard is located on the System Administration tab.

You must run the System Setup Wizard when you first install the Web Security appliance. After you finish the System Setup Wizard, the appliance is ready to monitor web traffic. However, you may want to make more custom configurations to the appliance that the System Setup Wizard does not cover. For more information about configuration options, see most of the other chapters in this guide.

Before you run the System Setup Wizard, see [Before You Begin, page 4-1](#) to verify you have all the information you need to configure the appliance. Having this information prepared ahead of time can reduce the amount of time required to complete the initial setup. You should also read the *QuickStart Guide* for more information about product setup.



---

**Running the System Setup Wizard completely reconfigures the Web Security appliance and resets the administrator password. Only use the System Setup Wizard the first time you install the appliance, or if you want to completely overwrite the existing configuration. Running the System Setup Wizard after the appliance is already configured can also interrupt client access to the web. If you choose to run the System Setup Wizard after performing an initial setup, use the System Administration > Configuration File pages to print a configuration summary and archive the current configuration file.**

---



---

**The appliance ships with a default IP address of 192.168.42.42 on the Management interface (port). Before connecting the appliance to the network, ensure that no other device on the network has the same IP address.**

---



---

**If you are setting up a virtual Web Security appliance, you will have to use the `loadlicense` command to load your virtual appliance license before running the System Setup Wizard. See the *Cisco Virtual Security Appliance Installation Guide* for more information.**

---

If you are connecting multiple factory-configured appliances to your network, add them one at a time, reconfiguring each appliance's default IP address as you go.

The System Setup Wizard includes the following tabs where you enter configuration information:

- **Start.** For details, see [Step 1. Accept the EULA and Begin Setup, page 4-6](#).
- **Network.** For details, see [Step 2. Configure Network Settings, page 4-7](#).
- **Security.** For details, see [Step 3. Security, page 4-12](#).
- **Review.** For details, see [Step 4. Review and Install, page 4-14](#).

## Accessing the System Setup Wizard

To access the System Setup Wizard, open a browser and enter the IP address of the Web Security appliance. The first time you run the System Setup Wizard, use the default IP address:

```
https://192.168.42.42:8443
```

-or-

```
http://192.168.42.42:8080
```

where 192.168.42.42 is the default IP address, and 8080 is the default admin port setting for HTTP, and 8443 is default admin port for HTTPS.

The appliance login screen appears. Enter the username and password to access the appliance. By default, the appliance ships with the following username and password:

- Username: **admin**
- Password: **ironport**

**Note**

---

Your session will time out if it is idle for over 30 minutes or if you close your browser without logging out. If this happens, you must re-enter the username and password.

---

## Step 1. Accept the EULA and Begin Setup

- 
- Step 1** Accept the terms of the end user license agreement by clicking the check box at the bottom of the page.
- Step 2** Click **Begin Setup** to continue.
-



## Step 2. Configure Network Settings

**Step 1** Configure the System Setting options, using the reference information in [Table 4-2](#); then click **Next**.

**Table 4-2 System Setting Options in System Setup Wizard**

Option	Description
Default System Hostname	The fully-qualified hostname for the Web Security appliance. This name should be assigned by your network administrator. This hostname is used to identify the appliance in system alerts.
DNS Server(s): Use the Internet's Root DNS Servers	<p>Configures the appliance to use the Internet root DNS servers for domain name service lookups.</p> <p>You might choose this option when the appliance does not have access to DNS servers on your network.</p> <p>The appliance requires access to a working DNS server in order to perform DNS lookups for incoming connections. If you cannot specify a working DNS server that the appliance can reach while you set up the appliance, you can configure it to use the Internet root DNS servers or temporarily assign the IP address of the Management interface so that you can complete the System Setup Wizard.</p> <p>For more information about configuring DNS settings, see <a href="#">Configuring DNS Server(s)</a>, page 25-17.</p>
DNS Server(s): Use these DNS Servers	<p>Specifies local DNS servers for domain name service lookups. You must enter at least one DNS server, and up to three total.</p> <p>You can choose to use the Internet root DNS servers or specify your own DNS servers.</p> <p>For more information about configuring DNS settings, see <a href="#">Configuring DNS Server(s)</a>, page 25-17.</p>
NTP Server	<p>Uses a Network Time Protocol (NTP) server to synchronize the system clock with other servers on the network or the Internet.</p> <p>By default, the Cisco IronPort time server (time.ironport.com) is entered.</p>
Time Zone	<p>Sets the time zone on the appliance so that timestamps in message headers and log files are correct. Use the drop-down menus to locate your time zone or to define the time zone using the GMT offset.</p> <p>For more information about the GMT offset, see <a href="#">Setting the Time Zone</a>, page 26-29.</p>

**Step 2** Optionally, configure an external proxy server using the reference information in [Table 4-3](#); then click **Next**.



**Note** You can configure the Web Security appliance to interact with multiple proxy servers on the network after you run the System Setup Wizard. For more information about configuring external proxy servers, see [Working with External Proxies Overview, page 10-1](#).

**Table 4-3 Network Context Options in System Setup Wizard**

Option	Description
Proxy group name	Choose a name for the proxy group.
Address	Enter the address of the proxy server in your organization network.
Port	The port number of the proxy server in your organization network.

The System Setup Wizard creates a proxy group with the information you provide in [Table 4-3](#). You can edit the proxy group later to include additional proxy servers and to configure load balancing options. You can also create additional proxy groups after system setup.



**Note** When you use the Web Security appliance in a network that contains another proxy server, it is recommended that you place the Web Security appliance downstream from the proxy server, closer to the clients.

**Step 3** Configure the Network Interfaces and Wiring options, using the reference information in [Figure 4-1](#) and [Table 4-4](#); then click **Next**.



**Note** The Web Security appliance has network interfaces that are associated with the physical ports on the machine.

Figure 4-1 System Setup Wizard – Network Tab, Network Interfaces and Wiring Page

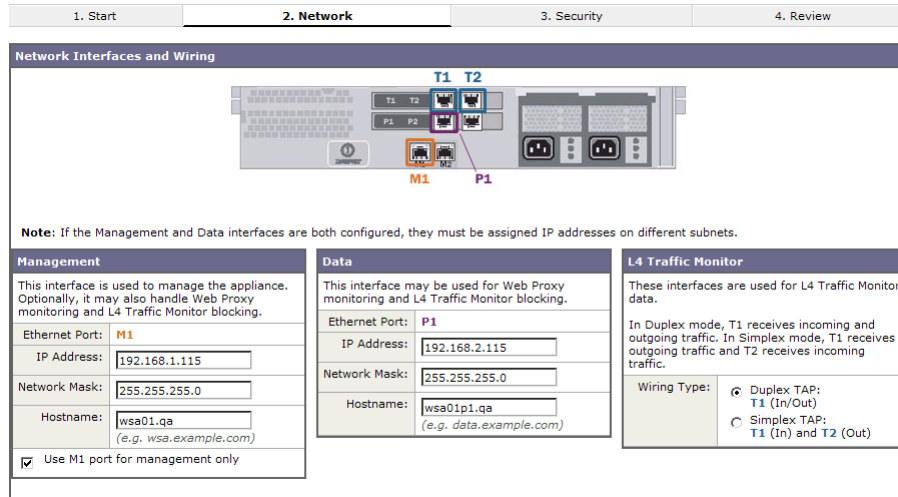

Table 4-4 Network Interfaces and Wiring Options in System Setup Wizard

Option	Description
Management	<p>Enter the IP address, network mask, and hostname to use to manage the Web Security appliance. Enter an IP address that exists on your management network.</p> <p>By default, the appliance uses the M1 interface for both management and proxy (data) traffic (the “Use M1 port for management only” check box is <i>disabled</i>).</p> <p>However, optionally, you can use the M1 interface for only management traffic by enabling the “Use M1 port for management only” check box. You might want to do this if your organization uses a separate management network. This can increase security by ensuring no proxy traffic can reach the appliance on management interface.</p> <p>When you use M1 for management traffic only, you must configure at least one data interface for proxy traffic. Also, you must define different routes for management and data traffic.</p>

**Table 4-4** Network Interfaces and Wiring Options in System Setup Wizard (continued)

Option	Description
Data	<p>Enter the IP address, network mask, and hostname to use for data traffic.</p> <p>If you configure the M1 interface for management traffic only, you must configure the P1 interface for data traffic. However, you can configure the P1 interface even when the M1 interface is used for both management and data traffic.</p> <p>You can use the Data interface for Web Proxy monitoring and optional L4 traffic monitoring. You can also configure this interface to support outbound services, such as DNS, software upgrades, NTP, and traceroute data traffic.</p> <p><b>Note:</b> You can only enable and configure the P1 network interface for data traffic in the System Setup Wizard. If you want to enable the P2 interface, you must use the <code>ifconfig</code> command after finishing the System Setup Wizard. For more information about configuring the P2 interface, see <a href="#">Configuring Network Interfaces, page 25-2</a>.</p>
L4 Traffic Monitor	<p>Choose the type of wired connections plugged into the “T” interfaces:</p> <ul style="list-style-type: none"> <li>• <b>Duplex TAP.</b> Choose Duplex TAP when the T1 port receives both incoming and outgoing traffic. You can use half- or full-duplex Ethernet connections.</li> <li>• <b>Simplex TAP.</b> Choose Simplex TAP when you connect the T1 port to the internal network (traffic flows from the clients to the Internet) and you connect the T2 port to the external network (traffic flows from the Internet to the clients).</li> </ul> <p>Cisco recommends using Simplex when possible because it can increase performance and security.</p>

**Step 4** Configure the Routes for Management and Data Traffic options, using the reference information in [Table 4-5](#); then click **Next**.



**Note** Options on this page vary with the “Use M1 port for management only” configuration.

**Table 4-5** Routes for Management and Data Traffic Options in System Setup Wizard

Option	Description
Default Gateway	Enter the default gateway IP address to use for the traffic through the Management and/or Data interface.
Static Routes Table	<p>Optionally, you can add one or more static routes for management or data traffic.</p> <p>To add a static route, enter a name for the route, its destination network, and gateway IP address, and then click <b>Add Route</b>. A route gateway must reside on the same subnet as the Management or Data interface on which it is configured.</p> <p>To delete a static route you entered, click the Delete button next to the static route entry in the table.</p> <p>For more information about static routes, see <a href="#">Configuring TCP/IP Traffic Routes, page 25-4</a>.</p>

**Step 5** Select a transparent connection option, using the reference information in [Table 4-6](#); then click **Next**.

**Note**

By default, when you run the System Setup Wizard, the Web Proxy is deployed in transparent mode. When the Web Proxy is deployed in transparent mode, you must connect it to a Layer 4 switch or a version 2 WCCP router.

**Table 4-6** *Transparent Connection Options in System Setup Wizard*

Option	Description
Layer 4 Switch or No Device	Choose this option when the Web Security appliance is connected to a layer 4 switch or if you will deploy the Web Proxy in explicit forward mode after running the System Setup Wizard.
WCCP v2 Router	<p>Choose this option when the Web Security appliance is connected to a version 2 WCCP capable router.</p> <p>If you connect the appliance to a version 2 WCCP router, you must create at least one WCCP service. You can enable the standard service (also known as the “web-cache” service) during system setup, and you can configure different or additional WCCP service groups after you run the System Setup Wizard.</p> <p>When you enable the standard service, choose whether or not to require a password for the standard service group. If required, enter the password in the password fields. The password can contain up to seven characters.</p> <p>For more information about creating WCCP services, see <a href="#">Adding and Editing a WCCP Service, page 25-14</a>.</p>

**Step 6** Configure the Administrative Settings options, using the reference information in [Table 4-7](#); then click **Next**.

**Table 4-7 Administrative Settings in System Setup Wizard**

Option	Description
Administrator Password	Enter a password to access the Web Security appliance. The password must be six characters or more.
Email System Alerts To	Enter an email address for the account to which the appliance sends alerts. For more information about alerts, see <a href="#">Managing Alerts, page 26-17</a> .
Send Email via SMTP Relay Host	You can enter a hostname or address for an SMTP relay host that AsyncOS uses for sending system generated email messages.  Optionally, you can enter the port number, too. If no port number is defined, AsyncOS uses port 25.  If no SMTP relay host is defined, AsyncOS uses the mail servers listed in the MX record.  For more information about configuring the SMTP relay hosts, see <a href="#">Configuring SMTP Relay Hosts, page 25-16</a> .
AutoSupport	Choose whether or not the appliance sends system alerts and weekly status report to Cisco IronPort Customer Support.
SensorBase Network Participation	Choose whether or not to participate in the Cisco SensorBase Network. If you participate, you can configure Limited or Standard (full) participation. Default is Standard.  The SensorBase Network is a threat management database that tracks millions of domains around the world and maintains a global watch list for Internet traffic. When you enable SensorBase Network Participation, the Web Security appliance sends anonymous statistics about HTTP requests to Cisco to increase the value of SensorBase Network data.  For more information about the SensorBase Network, see <a href="#">Participating in The Cisco SensorBase Network, page 2-11</a> .

## Step 3. Security

On the Security tab, you can configure which security services to enable, such as whether to block or monitor certain components. The Security tab contains one page.

**Step 1** Configure the Security Services options, using the reference information in [Table 4-8](#); then click **Next**.

**Table 4-8 Security Options in System Setup Wizard**

Option	Description
Global Policy Default Action	<p>Choose whether to block or monitor all web traffic by default after the System Setup Wizard completes. When you choose to block all traffic, the Global Access Policy blocks all proxied protocols, such as HTTP, HTTPS, and FTP. When you choose monitor, no proxied protocols are blocked. You can change this behavior later by editing the Protocols and User Agents settings for the Global Access Policy.</p> <p>You might want to block all traffic with the Global Access Policy until you can define appropriately restrictive user-defined Access Policies and then edit the Global Access Policy as necessary.</p>
L4 Traffic Monitor	<p>Choose whether the Layer-4 Traffic Monitor should monitor or block layer 4 traffic.</p> <p>The L4 Traffic Monitor detects rogue traffic across all network ports and stops malware attempts to bypass port 80.</p> <p>You might choose to monitor traffic when you evaluate the Web Security appliance, and block traffic when you purchase and use the appliance.</p> <p>For more information, see <a href="#">Configuring the L4 Traffic Monitor, page 21-2</a>.</p>
Acceptable Use Controls	<p>Choose whether or not to enable Acceptable Use Controls so you can use URL filtering. URL filtering allows you to control user access based on the category of a URL in a request. Enable this option when you want to restrict users from accessing particular types of websites.</p> <p>For more information, see <a href="#">URL Filters, page 17-1</a>.</p>
Reputation Filtering	<p>Choose whether or not to enable Web Reputation filtering for the Global Policy Group. When you create custom Access Policy groups, you can choose whether or not to enable Web Reputation filtering.</p> <p>Web Reputation Filters is a security feature that analyzes web server behavior and assigns a reputation score to a URL to determine the likelihood that it contains URL-based malware.</p> <p>Enable this option when you want to identify suspicious activity and stop malware attacks before they occur.</p> <p>For more information, see <a href="#">Web Reputation Filters Overview, page 19-2</a>.</p>

**Table 4-8 Security Options in System Setup Wizard (continued)**

Option	Description
Malware and Spyware Scanning	<p>Choose whether or not to enable malware and spyware scanning using Webroot, McAfee, or Sophos. If enabled, also choose whether to monitor or block detected malware.</p> <p>You might choose to monitor malware when you evaluate the Web Security appliance, and block malware when you purchase and use the appliance.</p> <p>You can further configure malware scanning after you finish the System Setup Wizard. For details, see <a href="#">Configuring Web Reputation and Anti-Malware in Policies, page 19-10</a>.</p>
Cisco IronPort Data Security Filtering	<p>Choose whether or not to enable Cisco IronPort Data Security Filters. The Cisco IronPort Data Security Filters evaluate data leaving the network over HTTP, HTTPS, and FTP to control what data goes where and how and by whom.</p> <p>Enable this option when you want to create Cisco IronPort Data Security Policies to block particular types of upload requests.</p> <p>For more information, see <a href="#">Data Security and External DLP Policies Overview, page 13-1</a>.</p>

## Step 4. Review and Install

The last tab of the System Setup Wizard displays a configuration summary.

**Step 1** Review the configuration information. If you need to change an option, click the **Edit** button for that section.

**Step 2** Click **Install This Configuration**.

If you changed the Management interface IP address from the current value, then clicking **Install This Configuration** will cause the connection to the current URL to be lost. However, your browser will redirect itself to the new IP address. If you did not change the IP address from the current value, the System Administration > System Setup > Next Steps page appears.



# 5

## Web Proxy Services

---

- [Overview of the Web Proxy, page 5-1](#)
- [Configuring the Web Proxy, page 5-3](#)
- [Working with FTP Connections, page 5-7](#)
- [Custom Headers, page 5-6](#)
- [Bypassing the Web Proxy, page 5-11](#)
- [Bypassing Application Scanning from Web Proxy Scanning, page 5-13](#)
- [Proxy Usage Agreement, page 5-13](#)
- [Configuring Client Applications to Use the Web Proxy, page 5-14](#)
- [Working with PAC Files, page 5-14](#)
- [Adding PAC Files to the Web Security Appliance, page 5-17](#)
- [Advanced Proxy Configuration, page 5-20](#)

## Overview of the Web Proxy

Using the Web Security appliance as a web proxy on your network, you can process and control network traffic that uses these transport protocols:

- HTTP
- FTP
- HTTPS
- SOCKS

When enabled, the web proxy processes HTTP and FTP traffic. To process HTTPS traffic, you need to enable the web proxy and the HTTPS proxy. To process SOCKS traffic, you need to enable the web proxy and the SOCKS proxy.

### Related Topics

- [Enabling Processing of HTTP Traffic, page 5-2](#)
- [Enabling Processing of HTTPS Traffic, page 5-2](#)
- [Configuring FTP Proxy Settings, page 5-9](#)
- [Enabling Processing of SOCKS Traffic, page 6-2](#)

# About Web Proxy Services

A web proxy is a computer system or software that handles World Wide Web requests of clients by making requests of other servers on the web. The Web Security appliance can act as a web proxy if you enable the Web Proxy feature.

The Web Proxy service monitors and controls traffic that originates from clients on the internal network. Typically, the Web Proxy-enabled Web Security appliance is deployed between clients and the firewall where it intercepts requests for content from clients to servers.

## Enabling Processing of HTTP Traffic

- 
- Step 1** Navigate to **Security Services > Web Proxy**.
  - Step 2** Click **Edit Settings**.
  - Step 3** Select **Enable Web Proxy**.
  - Step 4** **Submit** and **Commit** changes.
- 

### Related Topics

- [Configuring the Web Proxy, page 5-3](#)
- [Enabling Processing of HTTPS Traffic, page 5-2](#)
- [Configuring FTP Proxy Settings, page 5-9](#)
- [Enabling Processing of SOCKS Traffic, page 6-2](#)

## Enabling Processing of HTTPS Traffic

### Before You Begin

Processing of HTTP and FTP traffic must also be enabled before you can enable processing of HTTPS traffic.

- 
- Step 1** Navigate to **Security Services > HTTPS Proxy**.
  - Step 2** Click **Edit Settings**.
  - Step 3** Select **Enable HTTPS Proxy**.
  - Step 4** **Submit** and **Commit** changes.
- 

### Related Topics

- [Chapter 11, “Processing HTTPS Traffic”](#)

# Web Proxy Deployment Options

You can configure the Web Proxy as one of the following types:

- **Transparent Proxy.** When the appliance is configured as a transparent proxy, clients are unaware of the Web Proxy. Client applications, such as web browsers, do not have to be configured to accommodate the appliance. You might want to configure the appliance as a transparent proxy because it eliminates the possibility of users reconfiguring their web browsers to bypass the appliance without knowledge of the administrator. To configure the appliance as a transparent proxy, you must connect it to an Layer 4 switch or a WCCP router.

For information about how to configure the appliance when you configure the proxy in transparent mode, see [Configuring Transparent Redirection, page 25-11](#).

- **Explicit Forward Proxy.** In an explicit forward proxy configuration, the appliance acts on behalf of client web browsers to handle requests for servers on the web. Users must configure their web browsers to point to a single Web Security appliance. You might want to configure the appliance as an explicit forward proxy if you do not have an Layer 4 switch or a WCCP router.

You can use the Web Security appliance in a network that includes another proxy server. For more information about how to deploy and configure the appliance when the network contains another proxy, see [Using the Web Security Appliance in an Existing Proxy Environment, page 3-10](#).

The Web Proxy handles both HTTP and native FTP transactions. For more information about working with FTP, see [Working with FTP Connections, page 5-7](#).

## Web Proxy Cache

By default, AsyncOS uses a web proxy cache to increase performance for users accessing the web in some cases.

You can edit the web proxy and proxy cache in the following ways:

- **Remove a URL from the cache.** Use the `evict` subcommand of the `webcache` CLI command to remove one or more URLs from the cache.
- **Specify a domain or URL to never cache.** Use the `ignore` subcommand of the `webcache` CLI command to specify one or more domains or URLs that the web proxy should never store in the proxy cache. You can include embedded regular expression (regex) characters in the URL you specify to never cache.

Each access log file entry includes transaction result codes that describe how the appliance resolved client requests. Transaction result codes indicate whether the transaction was served from the proxy cache or from the destination server. For more information about transaction result codes, see [Transaction Result Codes, page 24-17](#).

## Configuring the Web Proxy

This page allows you to configure basic and advanced settings to customize proxy services.

The Web Proxy settings apply to all connections that go over HTTP or HTTPS. To configure proxy settings for native FTP connections, see [Working with FTP Connections, page 5-7](#).

---

**Step 1** Navigate to the Security Services > Web Proxy page.

- Step 2** Click **Edit Settings**.
- Step 3** Verify the Enable Proxy field is selected.
- Step 4** Configure the basic and advanced Web Proxy settings.

**Table 5-1 Web Proxy Settings**

Property	Description
HTTP Ports to Proxy	<p>Enter which ports the Web Proxy monitors for HTTP requests.</p> <p>Default is 80 and 3128.</p> <p>In deployments using WCCP, the maximum number of port entries is 30 for HTTP and HTTPS ports combined. You can use port ranges to reduce the number of entries. You can use both port numbers and port ranges. Example: 80, 3128, 14001-14015.</p>
Caching	With caching enabled, the Web Proxy caches requests and responses.
Proxy Mode	<p>Choose how to deploy the Web Proxy:</p> <ul style="list-style-type: none"> <li>• <b>Transparent mode.</b> Clients applications are unaware of the Web Proxy and do not have to be configured to connect to the proxy. In transparent mode, the Web Proxy can accept both transparently redirected and explicitly forwarded connections. For more information, see <a href="#">Deploying the Web Proxy in Transparent Mode, page 3-5</a>.</li> <li>• <b>Explicit forward mode.</b> Client applications, such as web browsers, are aware of the Web Proxy and must be configured to point to a single Web Security appliance. In explicit forward mode, the Web Proxy can only accept explicitly forwarded connections. For more information, see <a href="#">Deploying the Web Proxy in Explicit Forward Mode, page 3-4</a>.</li> </ul>
IP Spoofing	<p>Choose whether or not the Web Proxy should spoof IP addresses when sending requests to upstream proxies and servers.</p> <p>When the Web Proxy is deployed in transparent mode, you can enable IP spoofing for transparently redirected connections only or all connections (transparently redirected and explicitly forwarded).</p> <p>When IP spoofing is enabled, requests originating from a client retain the client's source address and appear to originate from the client rather than from the Web Security appliance.</p> <p><b>Note:</b> When IP spoofing is enabled and the appliance is connected to a WCCP router, configure a WCCP service to redirect the return path.</p>

Table 5-1 Web Proxy Settings (continued)

Property	Description
Persistent Connection Timeout	<p>Enter how long the Web Proxy keeps open a connection to a client or server after a transaction has been completed. Keeping a connection open allows the Web Proxy to use it again for another request.</p> <p>For example, after a client finishes a transaction with google.com, the Web Proxy keeps the connection to the server google.com open for the amount of time specified in the server side persistent timeout if no other client makes a request for google.com.</p> <ul style="list-style-type: none"> <li>• <b>Client side.</b> The maximum number of seconds the Web Proxy keeps a connection open with a client on the network with no activity from the client.</li> <li>• <b>Server side.</b> The maximum number of seconds the Web Proxy keeps a connection open with a destination server with no activity from any client on the network to that server.</li> </ul> <p>Default is 300 seconds for both client and server side persistent timeouts.</p> <p>You might want to increase the server side persistent timeout if clients on the network frequently connect to the same server, or if the network has a relatively slow connection to outside servers.</p> <p>Cisco recommends keeping the default values. However, you might want to increase or decrease these values to keep connections open longer to reduce overhead used to open and close connections repeatedly. Consider that if you increase the persistent timeout values, you also reduce the ability of the Web Proxy to open new connections if the maximum number of simultaneous persistent connections has been reached.</p>
In-Use Connection Timeout	<p>Enter how long the Web Proxy waits for more data from an idle client or server when the current transaction has not been completed.</p> <p>For example, if a client opens a connection and sends only half of the request, the Web Proxy waits for the amount of time specified for the client side reserve timeout for the rest of the request before closing the open connection.</p> <ul style="list-style-type: none"> <li>• <b>Client side.</b> The maximum number of seconds the Web Proxy keeps a connection open with an idle client.</li> <li>• <b>Server side.</b> The maximum number of seconds the Web Proxy keeps a connection open with an idle destination server.</li> </ul> <p>Default is 300 seconds for both client and server side reserve timeouts.</p>
Simultaneous Persistent Connections (Server Maximum Number)	<p>Enter the maximum number of connections (sockets) the Web Proxy keeps open with servers.</p>

Table 5-1 Web Proxy Settings (continued)

Property	Description
Generate Headers	<ul style="list-style-type: none"> <li>• <b>X-Forwarded-For.</b> Choose whether or not to forward HTTP “X-Forwarded-For” headers. Default is Do Not Send. Note: If the network contains an explicit forward upstream proxy that manages user authentication or access control using proxy authentication, you must enable the X-Forwarded-For header to send the client host header to the upstream proxy.</li> <li>• <b>VIA.</b> Choose whether or not to forward HTTP “VIA” headers in HTTP requests from clients and HTTP responses from servers. Default is Send.</li> </ul>
Use Received Headers	<p>Check the <b>Enable Identification of Client IP Addresses using X-Forwarded-For</b> check box if the appliance has been deployed as an upstream proxy and you want it to identify clients using the IP address specified in the X-Forwarded-For header instead of the IP address from the downstream proxy. You should only enable this option when the appliance receives client requests from a trustworthy downstream proxy or load balancer.</p> <p>When you enable this option, enter the IP address of a downstream proxy or load balancer. You cannot enter subnets or hostnames. Click <b>Add Row</b> to add more than one IP address. The Web Proxy will not accept the IP address in a X-Forwarded-For header from a machine that is not included in the list.</p> <p><b>Note</b> You can display the downstream IP address in the access logs using the <code>%XV</code> custom format specifier, and in the W3C access logs using the <code>x-request-source-ip</code> variable.</p>

**Step 5** Submit and commit your changes.

## Custom Headers

You can add custom headers to specific outgoing transactions to request special handling of your outgoing requests by specific domains. For example, if you have a relationship with YouTube for Schools, you can use a custom header to identify transaction requests to YouTube.com as coming from your network and requiring special handling.

You can log custom headers in the access log for troubleshooting purposes.

### Related Topics

- [Custom Header Options, page 5-30](#)
- [Custom Formatting in Access Logs and W3C Logs, page 24-28](#)
- [Configuring Custom Formatting in Access Logs, page 24-36](#)

# Working with FTP Connections

The Web Security appliance Web Proxy provides proxy services for the File Transfer Protocol (FTP) as well as HTTP. FTP is a protocol used to transfer data between computers over a network. The Web Proxy can handle the following FTP transactions:

- **FTP over HTTP.** Most web browsers support FTP transactions, but sometimes the transactions are encoded inside an HTTP transaction. All policies and configuration options that apply to HTTP transactions also apply to FTP over HTTP transactions.
- **Native FTP.** FTP clients use FTP to transfer data without invoking an HTTP connection. Native FTP connections are treated and handled differently than HTTP connections.

The component of the Web Proxy that handles native FTP transactions is referred to as the FTP Proxy. Native FTP connections can be served when the Web Proxy is deployed in either transparent or explicit forward mode.

Computers that transfer data using FTP create two connections between them. The control connection is used to send and receive FTP commands, such as RETR and STOR, and to communicate other information, such as the connection mode and file properties. The data connection is used to transfer the data itself. Typically, computers use port 21 for the control connection, and use a randomly assigned port (usually greater than 1023) for the data connection.

The FTP Proxy supports the following connection modes:

- **Passive.** In passive mode, the FTP server chooses the port used for the data connection and communicates this assignment to the FTP client. Passive mode is typically favored in most network environments where the FTP client is located behind a firewall and inbound connections (such as from an FTP server) are blocked. The default for the FTP Proxy is passive mode.
- **Active.** In active mode, the FTP client chooses the port used for the data connection and communicates this assignment to the FTP server.

FTP clients may support passive mode, active mode, or both. No matter which mode the FTP client uses to connect to the FTP Proxy, the FTP Proxy first attempts to use passive mode to connect to the FTP server. However, if the FTP server does not allow passive mode, the FTP Proxy uses active mode.

Consider the following rules and guidelines when working with native FTP connections:

- You can define which Identity groups apply to native FTP transactions.
- You configure FTP Proxy settings that apply to native FTP connections. For more information, see [Configuring FTP Proxy Settings, page 5-9](#).
- You can configure which welcome message users see in the FTP client when they connect to an FTP server. Configure the welcome banner when you configure the FTP Proxy settings.
- You can define a custom message the FTP Proxy displays in IronPort FTP notification messages when the FTP Proxy cannot establish a connection with the FTP server for any reason, such as an error with FTP Proxy authentication or a bad reputation for the server domain name. For more information, see [Configuring FTP Notification Messages, page 16-16](#).
- When the FTP Proxy is configured to cache native FTP transactions, it only caches content accessed by anonymous users.
- You can configure the FTP Proxy to spoof the IP address of the FTP server. You might want to do this when FTP clients do not allow passive data connections when the source IP address of the data connection (FTP server) is different than the source IP address of the control connection (FTP Proxy).

- If the connection between the FTP Proxy and the FTP server is slow, uploading a large file may take a long time when Cisco IronPort Data Security Filters are enabled. If the FTP client times out before the FTP Proxy uploads the entire file, users may notice a failed transaction.
- FTP clients can specify any TCP port for the control connection as long as they use proper formatting (hostname:port).
- Regardless of which mode the FTP client uses to connect to the FTP Proxy, the FTP Proxy first attempts to use passive mode to connect to the FTP server. However, if the FTP server does not allow passive mode, the FTP Proxy uses active mode.
- Access logs include entries for when users first start a native FTP session. Search the access log file for “FTP\_CONNECT” (explicit forward connections) and “FTP\_TUNNEL” (transparent connections).

## Using Authentication with Native FTP

The FTP Proxy performs user authentication to control which users can make native FTP requests. This user authentication determines which policy groups apply to the native FTP transaction.

However, due to the nature of FTP and FTP clients, only the following transactions can authenticate users for native FTP transactions:

- Explicit forward connections.
- Transparently redirected connections under any of the following conditions:
  - When users are identified transparently using either Novell eDirectory or Active Directory.
  - When the authentication surrogate is IP address and users make an HTTP transaction before the FTP transaction.
  - When users are remote users and they are identified by a Cisco adaptive security appliance using the Secure Mobility solution.

Due to this limitation, you may want to configure at least one Identity and Access Policy for native FTP transactions that do not require authentication when the Web Proxy is deployed in transparent mode. This allows all FTP connections that are transparently redirected to the Web Security appliance to work. If authentication is required for all policy groups, some transparently redirected native FTP transactions will fail. For example, transparently redirected native FTP transactions that use cookie authentication surrogates will fail.

You can configure the authentication format the FTP Proxy uses when communicating with FTP clients. The FTP Proxy supports the following formats for proxy authentication:

- **Check Point.** Uses the following formats:
  - User: ftp\_user@proxy\_user@remote\_host
  - Password: ftp\_password@proxy\_password
- **Raptor.** Uses the following formats:
  - User: ftp\_user@remote\_host proxy\_user
  - Password: ftp\_password
  - Account: proxy\_password
- **No Proxy Authentication.** Uses the following formats:
  - User: ftp\_user@remote\_host
  - Password: ftp\_password



When using authentication with native FTP, ensure that the FTP client uses the same authentication settings configured for the FTP Proxy.

You can use spaces and the @ character in FTP user names. However, you must precede these characters with a backslash character (\).

**Note**

Be careful when requiring authentication for native FTP transactions. FTP is inherently insecure because data (including the authentication credentials) is transmitted directly over the wire without encryption.

## Working with Native FTP in Transparent Mode

When the Web Security appliance is deployed in transparent mode, FTP clients typically are not explicitly configured to use the FTP Proxy. Native FTP connections are transparently redirected to the FTP Proxy and then processed.

When a native FTP request is transparently redirected to the FTP Proxy, it contains no hostname information for the FTP server, only its IP address. Because of this, the FTP Proxy only matches native FTP transactions with IP addresses configured in the Access Policies.

The predefined URL categories and Web Reputation Filters block by hostname and IP address, but for some servers, they may only have hostname information and not the server's IP address. For example, if the "News" predefined URL category contains the cnn.com, but not the corresponding IP address for that server, and if that URL category is configured to block, then native FTP connections to cnn.com will successfully connect instead of being blocked. Therefore, to make sure the FTP Proxy blocks native FTP connections to certain sites, you must create custom URL categories and enter the IP addresses in the list of sites to block or in the regular expression field.

## Configuring FTP Proxy Settings

The FTP Proxy settings apply to native FTP connections. To configure proxy settings that apply to FTP over HTTP connections, configure the Web Proxy. For more information, see [Configuring the Web Proxy, page 5-3](#).

- Step 1** Navigate to the Security Services > FTP Proxy page, and click **Edit Settings**.
- Step 2** Verify that the Enable FTP Proxy field is selected.
- Step 3** Configure the basic and advanced FTP Proxy settings.

Property	Description
Proxy Listening Port	Specify the port FTP clients should use to establish a control connection with the FTP Proxy.
Caching	Choose whether or not to cache contents of data connections from anonymous users.
Server Side IP Spoofing	Choose whether or not the FTP Proxy should spoof the FTP server IP address. You might want to do this for FTP clients that do not allow transactions when the IP address is different for the control and data connections.

Property	Description
Authentication Format	Choose the authentication format the FTP Proxy uses when communicating with FTP clients. For more information, see <a href="#">Using Authentication with Native FTP, page 5-8</a> .
Passive Mode Data Port Range	Specify a range of TCP ports FTP clients should use to establish a data connection with the FTP Proxy for passive mode connections. Default is 11000-11009.
Active Mode Data Port Range	Specify a range of TCP ports FTP servers should use to establish a data connection with the FTP Proxy for active mode connections. This setting applies to both native FTP and FTP over HTTP connections. Default is 12000-12099.  You might want to increase the port range in this field to accommodate more requests from the same FTP server. Because of the TCP session TIME-WAIT delay (usually a few minutes), a port does not become available again for the <i>same</i> FTP server immediately after being used. As a result, any given FTP server cannot connect to the FTP Proxy in active mode more than <i>n</i> times in a short period of time, where <i>n</i> is the number of ports specified in this field.
Welcome Banner	Choose which welcome message should appear in FTP clients: <ul style="list-style-type: none"> <li>• <b>FTP server message.</b> The FTP server message only displays for transparently redirected connections. When a native FTP connection is explicitly sent to the FTP Proxy, the FTP client displays a message predefined by the FTP Proxy.</li> <li>• <b>Custom message.</b> Enter a message to display for all native FTP connections.</li> </ul>
Control Connection Timeouts	Enter how long the FTP Proxy waits for more communication in the control connection from an idle FTP client or FTP server when the current transaction has not been completed.  For example, if an FTP client opens a control connection and sends some requests, the FTP Proxy waits for the amount of time specified for the client side control connection timeout for the next request before closing the open connection. <ul style="list-style-type: none"> <li>• <b>Client side.</b> The maximum number of seconds the FTP Proxy keeps a control connection open with an idle client.</li> <li>• <b>Server side.</b> The maximum number of seconds the FTP Proxy keeps a control connection open with an idle FTP server.</li> </ul> Default is 300 seconds for both client and server side control connection timeouts.

Property	Description
Data Connection Timeouts	<p>Enter how long the FTP Proxy waits for more communication in the data connection from an idle FTP client or FTP server when the current transaction has not been completed.</p> <p>For example, if an FTP client opens a data connection and sends only half of the request, the FTP Proxy waits for the amount of time specified for the client side data connection timeout for the rest of the request before closing the open connection.</p> <ul style="list-style-type: none"> <li>• <b>Client side.</b> The maximum number of seconds the FTP Proxy keeps a data connection open with an idle client.</li> <li>• <b>Server side.</b> The maximum number of seconds the FTP Proxy keeps a data connection open with an idle FTP server.</li> </ul> <p>Default is 300 seconds for both client and server side data connection timeouts.</p>

**Step 4** Submit and commit your changes.

## Bypassing the Web Proxy



### Note

For information about configuring the Application Scanning Bypass section, see [Bypassing Application Scanning from Web Proxy Scanning, page 5-13](#).

You can configure the Web Security appliance so client requests to or from particular addresses bypass all processing by the Web Proxy. The proxy bypass list only works for requests that are transparently redirected to the Web Proxy using an Layer 4 switch or a WCCP v2 router. When the appliance is deployed in explicit forward mode, or when a client makes an explicit request to the Web Proxy, the request is processed by the Web Proxy.

You might want to create a proxy bypass list to accomplish any of the following:

- Prevent the Web Proxy from interfering with non-HTTP-compliant (or proprietary) protocols using HTTP ports that do not work properly when they connect to a proxy server.
- Ensure that traffic from a particular machine inside the network, such as a malware test machine, bypasses the Web Proxy and all its built-in security protection.

Define the proxy bypass list on the Web Security Manager > Bypass Settings page.

[Figure 5-1](#) shows a sample proxy bypass list.

**Figure 5-1 Proxy Bypass List****Bypass Settings**

The screenshot shows two configuration panels. The top panel, titled "Proxy Bypass", has a text input field containing "intranet.example.com, internal.example.com" and an "Edit Proxy Bypass Settings..." button. The bottom panel, titled "Application Scanning Bypass", has a "Cisco WebEx:" label and a dropdown menu set to "Do Not Bypass Scanning", with an "Edit Application Bypass Settings..." button.

To include an address in the proxy bypass list, click **Edit Proxy Bypass Settings**. You can enter multiple addresses separated by line breaks or commas. You can enter addresses using any of the following formats:

- IP address, such as 10.1.1.0
- CIDR address, such as 10.1.1.0/24
- Hostname, such as crm.example.com
- domain names, such as example.com

**Note**

For the proxy bypass list to work with domain names, you need to connect the T1 and T2 network interfaces to the network *even if you do not enable the L4 Traffic Monitor*. For more information, see [Understanding How the Proxy Bypass List Works, page 5-12](#).

When transactions bypass the Web Proxy, AsyncOS for Web records them in the proxy bypass logs. For more information about logging, see [Working with Log Subscriptions, page 24-7](#).

**Note**

If the proxy bypass list contains an address that is a known malware address according to the L4 Traffic Monitor and the L4 Traffic Monitor sees a request for that address, then the request will still be blocked by the L4 Traffic Monitor. If you want to ensure traffic to that address is always allowed, you must also bypass the address from the L4 Traffic Monitor. For more information, see [Understanding How the L4 Traffic Monitor Works, page 21-1](#).

## Understanding How the Proxy Bypass List Works

When the Web Proxy receives an HTTP or HTTPS request, it checks both the source and destination IP address to see if it is in the proxy bypass list. If it is, the packet is sent to the next hop on the network. (In some cases, the packet is sent back to the transparent redirection device that redirected the packet, if the packet arrived on a WCCP service using GRE.)

The proxy bypass list works by matching the IP addresses of the request to an IP address in the proxy bypass list. When names are entered in the bypass list, the Web Proxy must resolve them to an IP address using DNS. The Web Proxy DNS resolves hostnames differently than domain names:

- **Hostnames.** Hostnames are resolved to IP addresses using DNS queries immediately after they are entered into the proxy bypass list. (An example hostname is `www.example.com`.)
- **Domain names.** Domain names cannot be resolved to IP addresses using DNS queries, so the Web Proxy uses DNS snooping using the T1 and T2 network interfaces. (An example domain name is `example.com`, and it matches both `www.example.com` and `webmail.example.com`.)

Because of these differences, if the proxy bypass list contains only IP addresses and hostnames, then the Web Proxy can easily match the IP address in the request header to the IP addresses in the proxy bypass list.

However, for the proxy bypass list to work with domain names, you must connect both the T1 and T2 network interfaces (if using simplex mode) or just connect the T1 network interface (if using duplex mode) to the network *even if you do not enable the L4 Traffic Monitor*. However, the proxy bypass list only bypasses the Web Proxy scanning. It does not bypass the L4 Traffic Monitor.

**Note**

If the transparent redirection device is a WCCP router, some are intelligent enough to not forward any other packets to the Web Proxy for the same session. In this case, the packets are not physically sent to the Web Proxy for the rest of the session and are truly bypassing it for the rest of the session.

## Using WCCP with the Proxy Bypass List

When the Web Security appliance is configured to use a WCCP v2 router, you must ensure that all WCCP services defined in the Web Security appliance use the same forwarding and return method (either L2 or GRE) to work properly with the proxy bypass list. If the forwarding and return methods do not match, some WCCP enabled routers will act inconsistently.

For more information, see [Working with the Forwarding and Return Method, page 25-13](#).

## Bypassing Application Scanning from Web Proxy Scanning

- 
- Step 1** Navigate to the Web Security Manager > Bypass Settings page.
  - Step 2** Click **Edit Application Bypass Settings**.
  - Step 3** Enable Bypass Scanning for the application to bypass.
  - Step 4** Submit and commit your changes.
- 

## Proxy Usage Agreement

You can configure the Web Security appliance to inform users that it is filtering and monitoring their web activity. The appliance does this by displaying an end-user acknowledgement page when a user first accesses a browser after a certain period of time. When the end-user acknowledgement page appears, users must click a link to access the original site requested or any other website. For more information about end-user acknowledgement pages, see [End-User Acknowledgement Page, page 16-11](#).

# Configuring Client Applications to Use the Web Proxy

Web browsers and other user agents sometimes need to know how to connect to the Web Proxy in order to access the World Wide Web. When you deploy the Web Security appliance in explicit forward mode, you *must* configure client applications so they use the Web Proxy. If you deploy the appliance in transparent mode, you can *choose* whether or not to configure client applications to explicitly use the Web Proxy.

You can configure client applications to explicitly use the Web Proxy by using any of the following configuration methods:

- **Manual.** Manual configuration involves typing the Web Security appliance hostname and port number, such as 3128, in each client application. If the appliance changes, you must edit each application individually. You might want to manually configure an application when you are testing proxy access on a single client machine. Cisco does not recommend manually configuring each client application to use the appliance Web Proxy.
- **Proxy auto-config (PAC) file.** For web browsers, you can configure each browser to use a PAC file to find the Web Proxy. Then you can edit the PAC file to specify the appliance Web Proxy information. For more information, see [Working with PAC Files, page 5-14](#).

For more information about how to configure client applications to use a proxy, see the client application documentation.

## Working with PAC Files

A proxy auto-config (PAC) file is a text file that defines how web browsers can automatically choose the appropriate proxy server for fetching a given URL.

When you use a PAC file, you only need to configure each browser once with the PAC file information. Then, you can edit the PAC file multiple times to add, delete, or change Web Proxy connection information without editing each browser. This way you can configure the proxy information about your network in a centralized location and update it easily.

**Note**

---

Once a browser has read a PAC file, it stores it in memory for the remainder of the browser session.

---

You might want to use a PAC file for the following reasons:

- **Centralized management.** You can manage the PAC file in a single, central location.
- **Complex network environment.** If the network of proxy servers is complicated, you can create a PAC file to accommodate different server and client needs.
- **Changing network environment.** If your network environment is likely to change in the future, you can easily add, edit, or delete proxy servers in the PAC and have the changes automatically affect all browsers.
- **Failover.** If you have multiple proxy servers, you can provide redundancy in case of failure. You can either program the PAC file to be redundant, or if a failure occurs, change the PAC file to use a different proxy server.

**Note**

---

Different browsers take different amounts of time to fail over to a secondary proxy. For example, Internet Explorer takes about 25 seconds, and Firefox takes about 50 seconds.

---

- **Load balancing.** If you have multiple proxy servers, you can use the PAC file to specify which requests go to which proxy server. For example, you might want users on one subnet to use a particular proxy and users on a different subnet to use a different proxy.

## PAC File Format

The PAC file must include at least one JavaScript function, `FindProxyForURL(url, host)`. The JavaScript function determines the appropriate proxy to use for each URL.

For example, if the Web Security appliance hostname is `WSA.example.com`, you could create a PAC file that includes the following text:

```
function FindProxyForURL(url, host) { return "PROXY WSA.example.com:3128; DIRECT"; }
```

**Note**

The port you specify in the `FindProxyForURL()` function should be a proxy port for the Web Security appliance configured on the Security Services > Web Proxy page.

However, you can make PAC files more complex. For example, you can create a PAC file that instructs the browser to connect directly to the website under certain conditions, such as matching on a particular hostname or IP address, and to use the proxy server in all other cases. You can create a PAC file that instructs applications to go directly to the website for servers on your intranet.

For more information about creating and using PAC files, see the following locations:

- [http://en.wikipedia.org/wiki/Proxy\\_auto-config](http://en.wikipedia.org/wiki/Proxy_auto-config)
- <http://www.mozilla.org/catalog/end-user/customizing/enduserPAC.html>
- <http://wp.netscape.com/eng/mozilla/2.0/relnotes/demo/proxy-live.html>

**Note**

Common convention is to use the `.pac` file extension for PAC file names.

## Creating a PAC File for Remote Users

Some laptop users connect to the Internet both from inside your organization's network and outside the network. For these users, you can create a PAC file that informs the browser to connect to the Web Proxy when they are on the network, and to connect directly to web servers when they are not on the network.

To do this, make sure the PAC file is hosted on a web server that is DNS resolvable inside the network, but not DNS resolvable outside the network. This works because when you enter a URL for the PAC file location, the browser will always try to use the PAC file in the configured location. If the browser cannot resolve the URL, such as when it is outside the network, it tries to access all web sites directly instead. Then when the laptop connects to the network again, the browser can access the PAC file and will use the Web Proxy to access web sites.

## Specifying the PAC File in Browsers

To use a PAC file, you must publish the PAC file in a location that can be accessed by each browser that needs to access it. When you configure a browser to use a PAC file, you can use either of the following methods:

- **Enter the PAC file location.** See [Entering the PAC File Location, page 5-16](#).
- **Detect the PAC file location automatically.** See [Detecting the PAC File Location Automatically, page 5-16](#).

### Entering the PAC File Location

You can configure a browser to use a PAC file by specifying the exact location of the file. You might want to enter the exact PAC file location for laptop users who might need to use different proxy servers depending on their current location.

You can place the PAC file in the following locations:

- **Local machine.** You can place the PAC file on each client machine and configure the browsers to use it. You might want to use a local PAC file to test a PAC file before deploying it to the entire organization. Enter the path in the browser configuration. The path you enter depends on the browser type.
- **Web server.** You can place the PAC file on a web server that each client machine can access. For example, you can place the PAC file on an Apache or Microsoft IIS web server. Enter the URL in the browser configuration.
- **Web Security appliance.** You can place the PAC file on the Web Security appliance. You might want to put the PAC file on the Web Security appliance to verify every client machine can access it within the network. Enter the URL in the browser configuration.

For more information about uploading PAC files to the Web Security appliance, see [Adding PAC Files to the Web Security Appliance, page 5-17](#).

### Detecting the PAC File Location Automatically

If a browser supports the Web Proxy Autodiscovery Protocol (WPAD), you can configure it to automatically detect the PAC file location. WPAD is a protocol that allows the browser determine the location of the PAC file using DHCP and DNS lookups.

Before fetching its first page, a web browser configured to automatically detect the PAC file location tries to find the PAC file using DHCP or DNS. Therefore, to use WPAD, you must set up either a DHCP server or a DNS server to direct web browser requests to the PAC file on a network server. However, not all browsers support DHCP to find the PAC file using WPAD.

This section includes some general guidelines for using WPAD with DNS “A” records. For more detailed information, or for information about using WPAD with DHCP, see the following locations:

- [http://en.wikipedia.org/wiki/Web\\_Proxy\\_Autodiscovery\\_Protocol](http://en.wikipedia.org/wiki/Web_Proxy_Autodiscovery_Protocol)
- <http://www.wpad.com/draft-ietf-wrec-wpad-01.txt>
- <http://www.microsoft.com/technet/isa/2004/plan/automaticdiscovery.msp>

When you use WPAD with DNS, each domain on the network can only use one PAC file for all users on a domain because only domain name can uniquely identify a PAC file using DNS. For example, users on `host1.accounting.example.com` and `host2.finance.example.com` can use different PAC files.



- 
- Step 1** Rename the PAC file to wpad.dat.
- Step 2** Create an internally resolvable DNS name that starts with “wpad,” such as wpad.example.com.
- Step 3** Place wpad.dat in the root directory of the website that will host the file, such as wpad.example.com. For information about placing the file on the Web Security appliance, see [Uploading PAC Files to the Appliance, page 5-19](#).



---

**Note** Due to a bug in Internet Explorer 6, create a copy of wpad.dat and change the file name to wpad.da to work with Internet Explorer 6 users. For more information, see [http://www.microsoft.com/technet/isa/2004/ts\\_wpad.mspx](http://www.microsoft.com/technet/isa/2004/ts_wpad.mspx).

---

- Step 4** Configure the web server to set up .dat files with the following MIME type:

```
application/x-ns-proxy-autoconfig
```



---

**Note** If you place wpad.dat on the Web Security appliance, the appliance does this for you already.

---

## Adding PAC Files to the Web Security Appliance

You can configure browsers to explicitly use the Web Proxy by using proxy auto-config (PAC) files. You can place PAC files on the Web Security appliance, and then configure the browsers in one of two ways: enter the URL of a PAC file on the appliance, or set the browsers to automatically detect the PAC file by using the Web Proxy Autodiscovery Protocol (WPAD).

You can add multiple PAC files to the appliance. You might want to add multiple PAC files if the appliance is used by multiple domains on the network. You can use one PAC file for all browsers on a domain.

When you add a PAC file to the appliance, you can specify one or more ports the appliance uses to listen for PAC file requests. For information on specifying the PAC file URL when it is hosted on the Web Security appliance, see [Specifying the PAC File URL, page 5-18](#).

When a browser asks for a PAC file, the appliance sends the file using HTTP. The PAC file is returned using MIME type `application/x-ns-proxy-autoconfig`.



---

**Note** When browsers are configured to use a PAC file on the appliance, the URL should include the PAC file name. If the URL does not specify the PAC file name, by default, the appliance uses `default.pac` if it exists and returns an error if it does not. Or, you can configure the default PAC file to use for different hostnames or domains on the network.

---

For more information about PAC files, see [Working with PAC Files, page 5-14](#).

## Specifying the PAC File URL

When you configure a browser to use a PAC file, you can specify the exact location of the file using a URL. When the PAC file is hosted on the Web Security appliance, you can specify the URL using any of the formats in [Table 5-2](#).

**Table 5-2** PAC File URL Formats

PAC File URL Format	Description
http://hostname.domain:port/filename	The PAC file <i>filename</i> is served if it exists; otherwise an error is returned.  This assumes <i>port</i> is a configured port on the appliance, and that <i>hostname</i> is the hostname of the appliance network interface configured for PAC file hosting.
http://hostname.domain:port/	The PAC file default.pac is served if it exists; otherwise an error is returned.  This assumes <i>port</i> is a configured port on the appliance, and that <i>hostname</i> is the hostname of the appliance network interface configured for PAC file hosting.
http://hostname:port/filename	The PAC file <i>filename</i> is served if it exists; otherwise an error is returned.  This assumes <i>port</i> is a configured port on the appliance, and that <i>hostname</i> is the hostname of the appliance network interface configured for PAC file hosting.
http://hostname:port/	The PAC file “default.pac” is served if it exists; otherwise an error is returned.  This assumes <i>port</i> is a configured port on the appliance, and that <i>hostname</i> is the hostname of the appliance network interface configured for PAC file hosting.
http://IPAddress:port/filename	The PAC file <i>filename</i> is served if it exists; otherwise an error is returned.  This assumes <i>port</i> is a configured port on the appliance, and that <i>IPAddress</i> is the IP address of the appliance network interface configured for PAC file hosting.
http://IPAddress:port/	The PAC file “default.pac” is served if it exists; otherwise an error is returned.  This assumes <i>port</i> is a configured port on the appliance, and that <i>IPAddress</i> is the IP address of the appliance network interface configured for PAC file hosting.
http://ConfiguredHostname/filename	The PAC file <i>filename</i> is served if it is configured on the appliance and exists; otherwise an error is returned.  This assumes that <i>ConfiguredHostname</i> is a hostname entered in the Hostname field on the Security Services > Proxy Auto-Configuration File Hosting page.

Table 5-2 PAC File URL Formats

PAC File URL Format	Description
http://ConfiguredHostname/	The configured default PAC file name for <i>ConfiguredHostname</i> is served if the hostname is configured on the Security Services > Proxy Auto-Configuration File Hosting page. This assumes port 80 is a configured port on the appliance and that <i>hostname</i> is the hostname of the appliance network interface configured for PAC file hosting. If the hostname is not configured, an error is returned.
http://IPAddress/filename	The PAC file <i>filename</i> is served if it is configured on the appliance and exists; otherwise an error is returned. This assumes that <i>IPAddress</i> is an IP address entered in the Hostname field on the Security Services > Proxy Auto-Configuration File Hosting page. If the IP address is not configured, an error is returned.
http://IPAddress/	The configured default PAC file name for <i>IPAddress</i> is served if the IP address is a configured hostname on the Security Services > Proxy Auto-Configuration File Hosting page. If the IP address is not configured, an error is returned.

## Uploading PAC Files to the Appliance

- Step 1** Navigate to Security Services > Proxy Auto-Configuration File Hosting page, and click **Enable and Edit Settings**.
- Step 2** In the PAC Server Ports field, enter one or more port numbers the Web Security appliance should use to listen for PAC file requests.
- Step 3** In the Interface field, select the interface the Web Proxy uses to listen for PAC file requests. You can choose any interface that is configured for data traffic. This field only appears when multiple interfaces are configured for data traffic.
- Step 4** In the PAC File Expiration section, choose whether to allow the PAC file to expire after a specified number of minutes in the browser's cache.
- Step 5** Click **Browse** to upload a PAC file from your local machine to the appliance.
- Step 6** Navigate to the PAC file location, select it, and click **Open**.
- Step 7** To add another PAC file, click **Add Row**, and repeat steps 5 and 6.  
Optionally, PAC files can be served through HTTP proxy ports, such as port 80. To allow this, you must explicitly configure the hostnames that should serve PAC files and choose a default PAC file for each hostname. The specified default PAC file name is served when browsers do not include the PAC file name when requesting the PAC file URL ("GET/" requests). Otherwise, the PAC file name specified in the URL is served. If a PAC file URL uses an IP address, you can enter the IP address as a configured hostname.
- Step 8** To configure a default PAC file name for different hostnames, in the Hostnames field enter the Web Security appliance hostname or IP address, or any hostname that resolves to the appliance hostname. Then choose the default PAC file name in the Default PAC File for "Get/" Request through Proxy Port field.

For example, if you enter *wsa.example.com* in the Hostnames field and *pacfile1.pac* in the Default PAC File for “Get/” Request through Proxy Port field, then requests for <http://wsa.example.com/> fetch *pacfile1.pac* and requests for <http://wsa.example.com/default.pac> fetch *default.pac*.

- Step 9** Optionally, repeat step 8 to configure a default PAC file name for all hostnames that resolve to the Web Security appliance.
- Step 10** Submit and commit your changes.
- 

## Understanding WPAD Compatibility with Netscape and Firefox

Netscape and Firefox browsers only use DNS to automatically detect PAC files using WPAD. Therefore, if you want Netscape and Firefox browsers to automatically detect a PAC file stored on the Web Security appliance, you must complete the following steps:

1. Name the PAC file *wpad.dat*.
2. Navigate to the Security Services > Web Proxy page, and delete port 80 from the HTTP Ports to Proxy field.
3. Use port 80 as the PAC Server Port when you upload the file to the appliance.

For more information about using WPAD, see [Detecting the PAC File Location Automatically](#), page 5-16.

**Note**

These steps also work with Internet Explorer. However, for Internet Explorer version 6, create a copy of *wpad.dat* and name it *wpad.da*.

---

## Advanced Proxy Configuration

AsyncOS includes the `advancedproxyconfig` CLI command so you can configure more advanced Web Proxy configurations, such as authentication and DNS parameters.

The `advancedproxyconfig` command includes the following subcommands:

Subcommand	Description								
Authentication	<p>Configure authentication parameters, such as the number of outstanding concurrent Basic or NTLMSSP authentication requests to be authenticated by the authentication server and whether or not to log the username that appears in the request URI. You can also use the <code>authentication</code> subcommand to enable the user acknowledgment page. For more information about the user acknowledgment page, see <a href="#">Proxy Usage Agreement, page 5-13</a>.</p> <p>For more information, see <a href="#">Authentication Options, page 5-23</a>.</p>								
Caching	<p>Configure advanced Web Proxy caching options, such as:</p> <ul style="list-style-type: none"> <li>• Whether or not to ignore client requests to not retrieve content from the proxy cache</li> <li>• Whether or not to cache content from an untrusted server</li> </ul> <p>You can configure the parameters separately by selecting “Customized Mode,” or you can choose from the modes shown below for a predefined set of parameter values. For more information, see <a href="#">Caching Options, page 5-27</a>.</p> <table border="1" data-bbox="643 831 1521 1785"> <tbody> <tr> <td data-bbox="643 831 862 1167">Safe mode</td> <td data-bbox="870 831 1521 1167"> <p>This mode uses less caching. You might want to use safe mode if clients are encountering web servers sending error responses with Last-Modified headers (so they get cached), and these are transient whereby you do not want to cache the error responses. Or, you might want to use safe mode if some web servers are not responding properly to If-Modified-Since queries, and caching objects when no cache lifetime is specified is causing incorrect cache hits.</p> <p>Provides most strict adherence to the RFC with respect to caching, performing less caching than the other modes.</p> </td> </tr> <tr> <td data-bbox="643 1178 862 1482">Optimized mode</td> <td data-bbox="870 1178 1521 1482"> <p>This mode uses moderate caching. This is the default mode. Compared to safe mode, in optimized mode the Web Proxy caches objects when no caching time is specified when a Last-Modified header is present. The Web Proxy caches negative responses.</p> <p>Provides less strict adherence to the RFC with respect to caching than Safe mode, but more than Aggressive. Performs more caching than Safe mode and less than Aggressive mode.</p> </td> </tr> <tr> <td data-bbox="643 1493 862 1734">Aggressive mode</td> <td data-bbox="870 1493 1521 1734"> <p>This mode uses aggressive caching. Compared to optimized mode, in aggressive mode the Web Proxy caches authenticated content, ETag mismatches, and content without a Last-Modified header. The Web Proxy ignores the no-cache parameter.</p> <p>Provides least strict adherence to the RFC with respect to caching. Performs the most caching of the modes.</p> </td> </tr> <tr> <td data-bbox="643 1745 862 1785">Customized mode</td> <td data-bbox="870 1745 1521 1785"> <p>This mode allows you to configure each parameter individually.</p> </td> </tr> </tbody> </table>	Safe mode	<p>This mode uses less caching. You might want to use safe mode if clients are encountering web servers sending error responses with Last-Modified headers (so they get cached), and these are transient whereby you do not want to cache the error responses. Or, you might want to use safe mode if some web servers are not responding properly to If-Modified-Since queries, and caching objects when no cache lifetime is specified is causing incorrect cache hits.</p> <p>Provides most strict adherence to the RFC with respect to caching, performing less caching than the other modes.</p>	Optimized mode	<p>This mode uses moderate caching. This is the default mode. Compared to safe mode, in optimized mode the Web Proxy caches objects when no caching time is specified when a Last-Modified header is present. The Web Proxy caches negative responses.</p> <p>Provides less strict adherence to the RFC with respect to caching than Safe mode, but more than Aggressive. Performs more caching than Safe mode and less than Aggressive mode.</p>	Aggressive mode	<p>This mode uses aggressive caching. Compared to optimized mode, in aggressive mode the Web Proxy caches authenticated content, ETag mismatches, and content without a Last-Modified header. The Web Proxy ignores the no-cache parameter.</p> <p>Provides least strict adherence to the RFC with respect to caching. Performs the most caching of the modes.</p>	Customized mode	<p>This mode allows you to configure each parameter individually.</p>
Safe mode	<p>This mode uses less caching. You might want to use safe mode if clients are encountering web servers sending error responses with Last-Modified headers (so they get cached), and these are transient whereby you do not want to cache the error responses. Or, you might want to use safe mode if some web servers are not responding properly to If-Modified-Since queries, and caching objects when no cache lifetime is specified is causing incorrect cache hits.</p> <p>Provides most strict adherence to the RFC with respect to caching, performing less caching than the other modes.</p>								
Optimized mode	<p>This mode uses moderate caching. This is the default mode. Compared to safe mode, in optimized mode the Web Proxy caches objects when no caching time is specified when a Last-Modified header is present. The Web Proxy caches negative responses.</p> <p>Provides less strict adherence to the RFC with respect to caching than Safe mode, but more than Aggressive. Performs more caching than Safe mode and less than Aggressive mode.</p>								
Aggressive mode	<p>This mode uses aggressive caching. Compared to optimized mode, in aggressive mode the Web Proxy caches authenticated content, ETag mismatches, and content without a Last-Modified header. The Web Proxy ignores the no-cache parameter.</p> <p>Provides least strict adherence to the RFC with respect to caching. Performs the most caching of the modes.</p>								
Customized mode	<p>This mode allows you to configure each parameter individually.</p>								

Subcommand	Description
CUSTOMHEADERS	Manage custom request headers for specific domains. This allows you to specify a custom header to be inserted for specific domains. For example, schools can use custom YouTube headers to restrict students who are using school internet services from accessing YouTube videos that are not part of the YouTube for Schools program. See <a href="#">Custom Header Options, page 5-30</a> ,
DNS	Configure DNS-related options, such as the time to cache results of DNS errors and whether or not the Web Proxy should issue an HTTP 302 redirection on DNS lookup failure. For more information, see <a href="#">DNS Options, page 5-30</a> .
EUN	Configure the end-user notification page settings, such as whether to use the standard IronPort end-user notification pages or use pages you customize. For more information on configuring the end-user notification pages, see <a href="#">Configuring FTP Notification Messages, page 16-16</a> . See <a href="#">EUN Options, page 5-32</a> .
FTPOVERHTTP	Configure the login name and password to use for anonymous FTP access and whether or not to allow active mode for FTP transfers. Applies to FTP over HTTP transactions only. See <a href="#">FTPOVERHTTP Options, page 5-35</a> . Also see <a href="#">NATIVEFTP</a> , below.
HTTPS	Configure the logging style for URIs used in HTTPS transactions. You can choose to record the full URI (“fulluri”) or just a portion of the URI with the query portion removed (“stripquery”). For more information, see <a href="#">HTTPS Options, page 5-35</a> .
NATIVEFTP	Configure the FTP Proxy settings, such as the port ranges to use for active and passive mode and the type of authentication to use for explicit forward connections. Applies to native FTP transactions only. See <a href="#">Configuring FTP Proxy Settings, page 5-9</a> . Also see <a href="#">NATIVE FTP Options, page 5-33</a> .
PROXYCONN	Identify user agents for which AsyncOS should not include the proxy connection header. See <a href="#">Proxyconn Options, page 5-36</a>
SCANNING	Configure how the DVS engine handles anti-malware scanning of web transactions. See <a href="#">Scanning Options, page 5-36</a> .
SOCKS	Configure SOCKS proxy parameters. See <a href="#">SOCKS Options, page 5-36</a> .
MISCELLANEOUS	Configure whether or not the Web Proxy should respond to health checks from Layer 4 switches and whether or not the Web Proxy should perform dynamic adjustment of TCP receive window sizes.  See <a href="#">Miscellaneous Options, page 5-37</a> .

Each submenu command is discussed in the detail tables below. For the Default Value column, a string means a name or list of characters such as “hello world.”

## Authentication Options

Table 5-3 describes the authentication options for the `advancedproxyconfig` CLI command.

**Table 5-3** *advancedproxyconfig* CLI Command—Authentication Options

Option	Valid Values	Default Value	Web Proxy Must Restart	Description
When would you like to forward authorization request headers to a parent proxy?	Never, Always, Only if not used by the WSA	Never	Yes	This setting determines whether the Web Proxy includes the “Proxy-Authorization” header to upstream servers, including proxies.
Enter the Proxy Authorization Realm to be displayed in the end user authentication dialog	String	“Cisco IronPort Web Security Appliance”	No	Proxy Authorization Realm displayed in the End User Authentication dialog.
Would you like to log the username that appears in the request URI?	Yes, No (Boolean)	No	No	If enabled, ‘<username>:xxxxx’ is logged i.e the username is displayed and the password is represented as a string, ‘xxxxx’. If disabled, both username and password are stripped. Note that the actual password is never displayed regardless of the value of this variable.
Should the Group Membership attribute be used for directory lookups in the Web UI (when it is not used, empty groups and groups with different membership attributes will be displayed)?	Yes, No (Boolean)	No	No	Choose whether or not AsyncOS should use the group membership attribute when doing a directory lookup.  If you do not want to display empty authentication groups and fetch groups whose group membership attribute is different, choose Yes.
Would you like to use advanced Active Directory connectivity checks?	Yes, No (Boolean)	No	No	Choose whether or not the Web Proxy should automatically restart the internal authentication process that communicates with Active Directory servers when it becomes unresponsive, but is still running.
Would you like to allow case insensitive username matching in policies?	Yes, No (Boolean)	Yes	Yes	Choose whether or not the Web Proxy should ignore case when matching user names against the policy groups.

Table 5-3 *advancedproxyconfig CLI Command—Authentication Options (continued)*

Option	Valid Values	Default Value	Web Proxy Must Restart	Description
Would you like to allow wild card matching with the character * for LDAP group names?	Yes, No (Boolean)	Yes	Yes	Choose whether or not to match an asterisk as a wildcard in LDAP group filters.  When this option is disabled, using an asterisk (*) in the group filters for LDAP servers works as a literal string.
Enter the charset to be used for basic authentication [ISO-8859-1/UTF-8].	ISO-8859-1, UTF-8	ISO-8859-1	No	Choose the character encoding that the Web Proxy should use when reading the Basic authentication credentials in the HTTP request. The setting configured here does not affect the request content, only the Basic authentication credentials.  You might want to use ISO-8859-1 if most web browsers used on your network are Internet Explorer, Firefox, and Safari, and UTF-8 if most web browsers on your network are Opera and Chrome.  <b>Note:</b> The Web Proxy always uses UTF-8 when sending the Basic authentication credentials to the authentication server.
Would you like to enable referrals for LDAP?	Yes, No (Boolean)	No	Yes	Choose whether or not the Web Proxy should perform LDAP queries on a referred LDAP server.  You might want to disable this option if a referred LDAP server is unavailable to the Web Security appliance.
Would you like to enable secure authentication?	Yes, No (Boolean)	No	Yes/No (Web Proxy restarts when it needs to listen on fewer or additional ports)	Choose whether or not the Web Proxy redirects clients to securely pass authentication credentials to the Web Proxy using HTTPS.  For more information on this feature, see <a href="#">Sending Authentication Credentials Securely</a> , page 20-23.



**Table 5-3** *advancedproxyconfig CLI Command—Authentication Options (continued)*

Option	Valid Values	Default Value	Web Proxy Must Restart	Description
Enter the redirect port for secure authentication.	1 to 65535	443	Yes/No (Web Proxy restarts when it needs to listen on fewer or additional ports)	Enter the port to use for redirecting requests using HTTPS. Cisco recommends using a port greater than 1023.  For more information on configuring this option, see <a href="#">Configuring Global Authentication Settings, page 20-18</a> .  <b>Note:</b> This option only appears when you enable secure authentication.
Enter the hostname to redirect clients for authentication.	String	Appliance hostname	No	Enter the short hostname of the network interface on which the Web Proxy listens for incoming connections.  When you enable secure authentication, the Web Proxy uses this hostname in the redirection URL sent to clients for authenticating users.  For more information on configuring this option, see <a href="#">Configuring Global Authentication Settings, page 20-18</a> .
Enter the surrogate timeout for user credentials.	Time in seconds	3600	No	This setting specifies how long the surrogate (IP address or cookie) can be used for user credentials before requiring authentication credentials again.  For more information on configuring this option, see <a href="#">Configuring Global Authentication Settings, page 20-18</a> .

Table 5-3 *advancedproxyconfig CLI Command—Authentication Options (continued)*

Option	Valid Values	Default Value	Web Proxy Must Restart	Description
Enter the surrogate timeout for machine credentials.	Time in seconds	10	No	<p>This setting specifies how long the IP address surrogate used for machine credentials (instead of user credentials) can be used before requiring authentication. You might want to configure this value if the network contains users on Windows 7 or Windows Vista machines that use the Network Connectivity Status Indicator (NCSI) feature.</p> <p>For more information, see <a href="#">Working with Windows 7 and Windows Vista, page 20-4</a>.</p>
Enter re-auth on request denied option [disabled / embedlinkinblockpage]?	disabled/ embedlink inblockpa ge	disabled	No	<p>This setting allows users to authenticate again if the user is blocked from a website due to a restrictive URL filtering policy.</p> <p>The user sees a block page that includes a link that allows them to enter new authentication credentials. If the user enters credentials that allow greater access, the requested page appears in the browser.</p> <p><b>Note:</b> This setting only applies to authenticated users who are blocked due to restrictive URL filtering policies. It does not apply to blocked transactions by subnet with no authentication.</p> <p>For more information, see <a href="#">Allowing Users to Re-Authenticate, page 20-25</a>.</p>

**Table 5-3** *advancedproxyconfig CLI Command—Authentication Options (continued)*

<b>Option</b>	<b>Valid Values</b>	<b>Default Value</b>	<b>Web Proxy Must Restart</b>	<b>Description</b>
Would you like to send Negotiate header along with NTLM header for NTLMSSP authentication:	1, 2	1	No	Choose whether or not the Web Proxy sends “Negotiate” as an acceptable authentication protocol when establishing the NTLM handshake with the Active Directory server. Choose one of the following values:  1. Do not send Negotiate header 2. Send Negotiate header
Configure username and IP address masking in logs and reports:	1, 2, 3	3	No	Choose whether or not to mask user names and/or IP addresses in logs and reports. Masked user names appear as “AUTHENTICATED_USER” in the logs, but guest user names are not masked.  Choose one of the following options:  1. Mask both user names and IP addresses in logs and reports 2. Mask only usernames and replace them with IP addresses in logs and reports 3. Show usernames and IP addresses in logs and reports

## Caching Options

The Caching submenu provides four options to set the advanced caching mode.

Table 5-4 describes the caching options for the Customized Mode option in the `advancedproxyconfig` CLI command.

**Table 5-4** *advancedproxyconfig* CLI Command—Caching Options

Option	Valid Values	Default Value	Web Proxy Must Restart	Description
Would you like to allow objects with a heuristic expiration time to be served as not-modified If-Modified-Since hits from cache?	Yes, No (Boolean)	Yes	No	0 = favor freshness on IMS to objects with heuristic expiration time 1 = favor bandwidth conservation
Would you like to allow ETAG mismatch on client revalidations?	Yes, No (Boolean)	No	No	In some cases, the server might report different ETags for the same version of the same file. This can be seen, for example, with clustered IIS servers. In these cases, requiring both a last modified time (LMT) match and an ETag match on client revalidations would lead to a lot of misses, so it should be sufficient just to match the LMT if it is given. <b>Note:</b> Setting this to 1 is not HTTP-compliant.
Would you like to allow caching when requests are authenticated by the origin server?	Yes, No (Boolean)	No	Yes	Allow caching for requests authenticated by origin server.
Would you like to allow caching from servers whose DNS results do not match the TCP destination IP (not trust-worthy and applicable only in transparent modes)?	Yes, No (Boolean)	No	Yes	Allow caching from servers whose DNS results do not match the TCP destination IP.
Enter the Heuristic maximum age to cache the document with Last-Modified Time but no actual caching value (in seconds):	Time in seconds	86400	No	Heuristic maximum age to cache the document with LMT but no actual caching value.
Enter the Heuristic maximum age to cache the document without Last-Modified Time and no actual caching value (in seconds):	Time in seconds	0	No	Heuristic maximum age to cache the document without LMT and no actual caching value.

**Table 5-4** *advancedproxyconfig CLI Command—Caching Options (continued)*

<b>Option</b>	<b>Valid Values</b>	<b>Default Value</b>	<b>Web Proxy Must Restart</b>	<b>Description</b>
Enter the Heuristic age to cache errors (HTTP_SERVICE_UNAVAIL, HTTP_GATEWAY_TIMEOUT etc) (in seconds):	Time in seconds	300	No	Heuristic age to cache errors (HTTP_SERVICE_UNAVAIL, HTTP_GATEWAY_TIMEOUT etc).
Would you like proxy to ignore client directive to not fetch content from the cache?	Yes, No (Boolean)	No	No	Disable/Enable ignoring of the client directive to not fetch content from the cache. Enabling this is not HTTP compliant.
Enter the time interval during which reload requests must be ignored by the proxy (in seconds):	Time in seconds	0	No	Disable/Enable reload requests to be ignored for the specified time interval.  This allows reload requests to be ignored for a certain amount of time, even though it is not HTTP-compliant.  You might want to enter a value greater than zero to improve bandwidth usage.
Would you like to allow proxy to convert reload requests into max-age requests?	Yes, No (Boolean)	No	No	Allow reload requests to be converted into max-age requests (not HTTP-compliant, but may improve bandwidth usage). This gets its max-age value from "ignoreReloadTime."
Time in seconds after which an explicit IMS Refresh request must be issued:	Time in seconds	300	No	Time in seconds after which an explicit IMS Refresh request must be issued.

## Custom Header Options

**Table 5-5** *advancedproxyconfig CLI Command—Custom Header Options*

Option	Valid Values	Default Value	Web Proxy Must Restart	Description
Delete	1,2,3	—	No	Deletes the custom header you identify. Identify the header to delete using the number associated with the header in the list returned by the command.
New	For header: String (name:value pair) in the format "header_name: header_text"  For domain: String (domain name or comma delimited list of domain names)	—	No	Creates the header you provide for use with the domain or domains you specify.  Example header: X-YouTube-Edu-Filter: ABCD1234567890abcdef  (The value in this case is a unique key provided by YouTube.)  Example domain: youtube.com
Edit	See New.	—	No	Replace an existing header with one you specify. Identify the header to delete using the number associated with the header in the list returned by the command.

## DNS Options

Table 5-6 describes the DNS options for the `advancedproxyconfig` CLI command.

**Table 5-6** *advancedproxyconfig CLI Command—DNS Options*

Option	Valid Values	Default Value	Web Proxy Must Restart	Description
Enter the URL format for the HTTP 307 redirection on DNS lookup failure:	String with EUN page variables	%P//www. .%H.com/ %u	No	URL format for the HTTP 307 redirection on DNS lookup failure. See Table 16-2, 'Variables for Customized End-User Notification Pages,' on page 6 for the list of valid variables.
Would you like the proxy to issue a HTTP 307 redirection on DNS lookup failure?	Yes, No (Boolean)	Yes	Yes	Disable/Enable automatic HTTP 307 redirection on DNS lookup failure.

**Table 5-6** *advancedproxyconfig CLI Command—DNS Options (continued)*

<b>Option</b>	<b>Valid Values</b>	<b>Default Value</b>	<b>Web Proxy Must Restart</b>	<b>Description</b>
Would you like proxy not to automatically failover to DNS results when upstream proxy (peer) is unresponsive?	Yes, No (Boolean)	No	Yes	Disable/Enable automatic failover to DNS results when upstream proxy (peer) is unresponsive.
Find web server by:	0, 1, 2, 3	1	Yes	Specify how the appliance should find the location of the requested web server. <ul style="list-style-type: none"> <li>• 0 = use DNS answers in order</li> <li>• 1 = use client supplied address then DNS</li> <li>• 2 = use ONLY client supplied address</li> <li>• 3 = use client supplied address for next hop connection and Web Reputation (Warning: Destination IP based policies will still use DNS).</li> </ul>

## EUN Options

Table 5-7 describes the EUN options for the `advancedproxyconfig` CLI command.

**Table 5-7** *advancedproxyconfig* CLI Command—EUN Options

Option	Valid Values	Default Value	Web Proxy Must Restart	Description
Choose:	1, 2, 3	3	Yes	Choose whether to use the IronPort end-user notification pages or uploaded customized end-user notification pages.  Choose one of the following options: <ul style="list-style-type: none"> <li>• 1. Refresh EUN pages</li> <li>• 2. Use Custom EUN pages</li> <li>• 3. Use Standard EUN pages</li> </ul> For more information, see <a href="#">Editing On-Box End-User Notification Pages</a> , page 16-5.
Would you like to turn on presentation of the User Acknowledgement page?	Yes, No (Boolean)	No	No	Enable or disable Acknowledgement page.
Enter the method to be used for tracking User Acknowledgements (“ip” or “session”).	ip, session	ip	No	This setting specifies the way that the Web Proxy tracks users, either by IP address or using a web session cookie, after the user clicked the link on the end-user acknowledgement page.  For more information on configuring this option, see <a href="#">End-User Acknowledgement Page</a> , page 16-11
Action to be taken for HTTPS requests with Session based EUA (“bypass” or “drop”).	bypass, drop	bypass	Yes	Choose whether to bypass (pass through) or drop HTTPS requests when the end-user acknowledgement page is enabled and tracks users using session cookies. For more information, see <a href="#">Accessing HTTPS and FTP Sites with the End-User Acknowledgement Page</a> , page 16-14.  This option only appears if you select Session Cookie for the User Acknowledgements tracking method.



**Table 5-7** *advancedproxyconfig CLI Command—EUN Options (continued)*

Option	Valid Values	Default Value	Web Proxy Must Restart	Description
Enter maximum time to remember User Acknowledgement (in seconds):	30 - 2678400	86400	No	Maximum time to remember User Acknowledgement. From 30 seconds to one month (2678400).
Enter maximum idle timeout for User Acknowledgement based on IP Address (in seconds):	30 - 2678400	14400	No	Maximum idle timeout for User Acknowledgement based on IP Address. From 30 seconds to one month (2678400).

## NATIVE FTP Options

Table 5-8 describes the NATIVE FTP options for the `advancedproxyconfig` CLI command.

**Table 5-8** *advancedproxyconfig CLI Command—NATIVEFTP Options*

Option	Valid Values	Default Value	Web Proxy Must Restart	Description
Would you like to enable FTP proxy?	Yes, No (Boolean)	Yes	Yes	Choose whether or not to enable the FTP Proxy.
Enter the ports that FTP proxy listens on.	1 to 65535	8021	Yes	Specify the port FTP clients should use to establish a control connection with the FTP Proxy.
Enter the range of port numbers for the proxy to listen on for passive FTP connections.	port1-port2 (string) 1024 - 65535	11000-11009	Yes	Specify a range of TCP ports FTP clients should use to establish a data connection with the FTP Proxy for passive mode connections.
Enter the range of port numbers for the proxy to listen on for active FTP connections.	port1-port2 (string) 1024 - 65535	12000-12099	Yes	Specify a range of TCP ports FTP servers should use to establish a data connection with the FTP Proxy for active mode connections. This setting applies to both native FTP and FTP over HTTP connections.
Enter the authentication format:	Check Point, Raptor	Check Point	Yes	Choose the authentication format the FTP Proxy uses when communicating with FTP clients. For more information, see <a href="#">Using Authentication with Native FTP, page 5-8</a> .
Would you like to enable caching?	Yes, No (Boolean)	Yes	Yes	Choose whether or not to cache contents of data connections from anonymous users.

Table 5-8 *advancedproxyconfig CLI Command—NATIVEFTP Options (continued)*

Option	Valid Values	Default Value	Web Proxy Must Restart	Description
Would you like to enable server IP spoofing?	Yes, No (Boolean)	No	Yes	Choose whether or not the FTP Proxy should spoof the FTP server IP address. You might want to do this for FTP clients that do not allow transactions when the IP address is different for the control and data connections.
Would you like to pass FTP server welcome message to the clients?	Yes, No (Boolean)	Yes	Yes	Choose which welcome message should appear in FTP clients: <ul style="list-style-type: none"> <li>• <b>FTP server message.</b> Enter “Yes.” The FTP server message only displays for transparently redirected connections. When a native FTP connection is explicitly sent to the FTP Proxy, the FTP client displays a message predefined by the FTP Proxy.</li> <li>• <b>Custom message.</b> Enter “No.” You can enter a custom message to display for all native FTP connections in the next question.</li> </ul>
Enter the customized server welcome message.	String	N/A	Yes	This command appears when you enter No for the FTP server welcome message.  Enter the custom message to display for all native FTP connections.
Enter the max path size for the ftp server directory:	Integer	1024	No	Enter the maximum length FTP clients can use for directory paths on the FTP server.

## FTPOVERHTTP Options

Table 5-9 describes the FTPOVERHTTP options for the `advancedproxyconfig` CLI command.

**Table 5-9** *advancedproxyconfig CLI Command—FTPOVERHTTP Options*

Option	Valid Values	Default Value	Web Proxy Must Restart	Description
Enter the login name to be used for anonymous FTP access:	String	anonymous	No	Anonymous FTP login name.
Enter the password to be used for anonymous FTP access:	String	proxy@	No	Anonymous FTP login password.

## HTTPS Options

Table 5-10 describes the HTTPS options for the `advancedproxyconfig` CLI command.

**Table 5-10** *advancedproxyconfig CLI Command—HTTPS Options*

Option	Valid Values	Default Value	Web Proxy Must Restart	Description
HTTPS URI Logging Style:	fulluri or stripquery	fulluri	Yes	You can log the entire URI (fulluri), or a partial form of the URI with the query portion removed (stripquery). However, even when you choose to strip the query from the URI, personally identifiable information may still remain.
Would you like to decrypt unauthenticated transparent HTTPS requests for authentication purpose?	Yes, No (Boolean)	Yes	No	Choose how the Web Proxy handles transparently redirected HTTPS transactions it receives before an HTTP request that was authenticated using an identity with an IP-based surrogate. Select one of the following options: <ul style="list-style-type: none"> <li><b>Yes.</b> Decrypt the HTTPS request for authentication purposes.</li> <li><b>No.</b> Deny the HTTPS request.</li> </ul>
Action to be taken when HTTPS servers ask for client certificate during handshake:	1, 2	2	Yes	Choose how the HTTPS Proxy responds to an HTTPS server when it asks for a client certificate during the SSL handshake: <ul style="list-style-type: none"> <li>1. Pass through the transaction</li> <li>2. Reply with certificate unavailable</li> </ul> <p><b>Note</b> You can read the Proxy Logs to learn when an HTTPS server requested a client certificate.</p>

## Proxyconn Options

Identify user agents for which AsyncOS should not include the proxy connection header.

**Table 5-11** *advancedproxyconfig CLI Command—Proxyconn Options*

Option	Valid Values	Default Value	Web Proxy Must Restart	Description
New	Regular Expression	—	No	A regular expression that matches a user agent.  Example: Mozilla/* Gecko/* Firefox/ matches all FireFox versions.
Delete	1,2,3[...]	—	No	An integer representing the user agent you want to delete. This option returns a numbered list of the user agents that are configured.

## Scanning Options

### Before You Begin

- Be aware that enabling malware scanning results in a significant performance impact for the Web Proxy.
- Disable Adaptive Scanning before editing scanning options.

**Table 5-12** *advancedproxyconfig CLI Command—Scanning Options*

Option	Valid Values	Default Value	Web Proxy Must Restart	Description
Would you like the proxy to do malware scanning all content regardless of content type?	Yes, No (Boolean)	No	No	Choose whether or not the DVS engine should scan all response content regardless of the content type.

## SOCKS Options

**Table 5-13** *advancedproxyconfig CLI Command—SOCKS Options*

Option	Valid Values	Default Value	Web Proxy Must Restart	Description
Would you like to enable SOCKS proxy?	Yes, No (Boolean)	N	Yes	—
Proxy Negotiation Timeout.	1-60	60	Yes	Time to wait (in seconds) to send or receive data from a SOCKS client in the negotiation phase. Default is 60.

**Table 5-13** *advancedproxyconfig CLI Command—SOCKS Options (continued)*

Option	Valid Values	Default Value	Web Proxy Must Restart	Description
UDP Tunnel Timeout.	1-60	60	Yes	Time to wait (in seconds) for data from a UDP client or server before closing the UDP tunnel. Default is 60.
SOCKS Control Ports.	Ports and port ranges between 1-65535	1080	Yes	Ports that accept SOCKS requests. Default is 1080.
UDP Request Ports.	Ports and port ranges between 1-65535	16000-16100	Yes	UDP ports on which the SOCKS server should listen. Default is 16000-16100.

## Miscellaneous Options

**Table 5-14** *advancedproxyconfig CLI Command—Miscellaneous Options*

Option	Valid Values	Default Value	Web Proxy Must Restart	Description
Would you like proxy to respond to health checks from Layer 4 switches (always enabled if WSA is in L4 transparent mode)?	Yes, No (Boolean)	No	Yes	Disable/Enable support for responding to health checks from Layer 4 switches (always enabled if WSA is in L4 transparent mode). Layer 4 switches issue 'HEAD / HTTP/1.0' requests directed at the proxy to ensure that it is responding.
Would you like proxy to perform dynamic adjustment of TCP receive window size?	Yes, No (Boolean)	Yes	Yes	Disable/Enable dynamic adjustment of TCP receive window size.
Enable caching of HTTPS responses?	Yes, No (Boolean)	No	No	Choose whether or not the Web Security appliance should store HTTPS responses in the web cache.
Enter minimum idle timeout for checking unresponsive upstream proxy (in seconds).	Time in seconds	10	No	The minimum amount of time the Web Proxy waits before checking if an upstream proxy is still unavailable.
Enter maximum idle timeout for checking unresponsive upstream proxy (in seconds).	Time in seconds	86400	No	The maximum amount of time the Web Proxy waits before checking if an upstream proxy is still unavailable.

Table 5-14 *advancedproxyconfig CLI Command—Miscellaneous Options (continued)*

Option	Valid Values	Default Value	Web Proxy Must Restart	Description
Mode of the proxy:	1, 2, 3	2	Yes	<p>Choose how to deploy the Web Proxy using one of the following options:</p> <ul style="list-style-type: none"> <li>1. Explicit forward mode only</li> <li>2. Transparent mode with L4 Switch or no device for redirection</li> <li>3. Transparent mode with WCCP v2 Router for redirection</li> </ul> <p>For more information, see <a href="#">Deployment Overview, page 3-1</a>.</p>
Spoofing of the client IP by the proxy:	1, 2, 3	1	No	<p>Choose whether or not the Web Proxy should spoof IP addresses when sending requests to upstream proxies and servers using one of the following options:</p> <ul style="list-style-type: none"> <li>1. Disable</li> <li>2. Enable for all requests</li> <li>3. Enable for transparent requests only</li> </ul> <p>When IP spoofing is enabled, requests originating from a client retain the client's source address and appear to originate from the client rather than from the Web Security appliance.</p> <p><b>Note</b> When IP spoofing is enabled and the appliance is connected to a WCCP router, configure a WCCP service to redirect the return path.</p>
Do you want to pass HTTP X-Forwarded-For headers?	Yes, No (Boolean)	Yes	No	<p>Choose whether or not the Web Proxy retains any "X-Forwarded-For" header included in the requests it receives.</p> <p>When set to No, the Web Proxy removes any "X-Forwarded-For" header from requests that enter the Web Proxy from a downstream proxy server. You might want to do this if the downstream proxy server includes client IP address in the header and you do not want to expose those IP addresses to servers outside your network.</p>

Table 5-14 *advancedproxyconfig CLI Command—Miscellaneous Options (continued)*

Option	Valid Values	Default Value	Web Proxy Must Restart	Description
Would you like to permit tunneling of non-http requests on http ports?	Yes, No (Boolean)	Yes	No	<p>Choose whether or not to allow non-HTTP traffic on ports the Web Proxy is configured to monitor, such as port 80. This option applies when the Web Proxy is in transparent mode.</p> <p>Enabling this option blocks applications that attempt to tunnel non-HTTP traffic on ports typically used for HTTP traffic.</p> <p><b>Note</b> When a transaction is blocked due to this setting, the ACL decision tag for the transaction is logged as BLOCK_ADMIN_TUNNELING.</p>
Would you like to block tunneling of non-SSL transactions on SSL Ports?	Yes, No (Boolean)	No	No	<p>Choose whether or not the Web Proxy should block non-SSL traffic on SSL ports.</p> <p>By default (when this feature is disabled), when a client seeks to connect to server on a configured SSL port and the SSL handshake with the server fails, the Web Proxy tunnels the transaction.</p>
Would you like proxy to log values from X-Forwarded-For headers in place of incoming connection IP addresses?	Yes, No (Boolean)	No	No	<p>Choose whether or not the access logs should include the X-Forwarded-For header value instead of the IP address of the incoming connection.</p>

Table 5-14 *advancedproxyconfig CLI Command—Miscellaneous Options (continued)*

Option	Valid Values	Default Value	Web Proxy Must Restart	Description
Do you want proxy to throttle content served from cache?	Yes, No (Boolean)	Yes	No	Choose whether or not the Web Proxy should apply per user bandwidth controls to content served from the web cache in addition to the content served from web servers. Applies to application types that have bandwidth limits applied.
Would you like the proxy to use client IP addresses from X-Forwarded-For headers?	Yes, No (Boolean)	No	No	<p>Choose whether or not the Web Proxy should accept a client IP address in the X-Forwarded-For header from a trusted downstream proxy or load balancer.</p> <p>If you choose “Yes,” enter the IP addresses of the downstream proxies or load balancers that the Web Proxy will trust. The Web Proxy will not accept the IP address in a X-Forwarded-For header from a machine that is not included in the list. Separate multiple IP addresses with commas. You cannot enter subnets or hostnames.</p> <p><b>Note</b> You can display the downstream IP address in the access logs using the %XV custom format specifier, and in the W3C access logs using the x-request-source-ip variable.</p>



# 6

## SOCKS Proxy Services

- [Overview of SOCKS Proxy Services, page 6-1](#)
- [Enabling Processing of SOCKS Traffic, page 6-2](#)
- [Configuring the SOCKS Proxy, page 6-2](#)
- [Creating SOCKS Policies, page 6-2](#)
- [Logging, page 6-4](#)

### Overview of SOCKS Proxy Services

The Web Security appliance includes a SOCKS proxy to process SOCKS traffic. SOCKS policies, which are the equivalent of access policies control SOCKS traffic. Like access policies, you can make use of Identities to specify which transactions are governed by which SOCKS policy. Like access policies, after SOCKS policies are applied to transactions, Routing policies can then govern routing of the traffic.

#### Notes

- The SOCKS protocol only supports direct forward connections.
- The SOCKS proxy does not support (will not forward to) upstream proxies.
- The SOCKS proxy does not support scanning services, which are used by Application Visibility and Control (AVC), Data Loss Prevention (DLP), and malware detection.
- The SOCKS proxy does not support policy tracing.
- The SOCKS proxy does not decrypt SSL traffic; it tunnels from client to server.

### How to Enable and Configure Processing of SOCKS Traffic

	Task	More Information
<b>Step 1</b>	Enable the Web Proxy.	<a href="#">Enabling Processing of HTTP Traffic, page 5-2</a>
<b>Step 2</b>	Enable the SOCKS Proxy.	<a href="#">Enabling Processing of SOCKS Traffic, page 6-2</a>
<b>Step 3</b>	Configure the SOCKS Proxy.	<a href="#">Configuring the SOCKS Proxy, page 6-2</a>
<b>Step 4</b>	(Optional) Add an Identity for use with SOCKS Policies.	<a href="#">Creating Identities, page 8-18</a>
<b>Step 5</b>	Add one or more SOCKS Policies to manage SOCKS traffic.	<a href="#">Creating SOCKS Policies, page 6-2</a>

## Enabling Processing of SOCKS Traffic

- 
- Step 1** Navigate to **Security Services > SOCKS Proxy**.
  - Step 2** Click **Edit Settings**.
  - Step 3** Select **Enable SOCKS Proxy**.
  - Step 4** **Submit** and **Commit** changes.
- 

### Go back to

- [How to Enable and Configure Processing of SOCKS Traffic, page 6-1](#)

## Configuring the SOCKS Proxy

- 
- Step 1** Navigate to the **Security Services > SOCKS Proxy** page.
  - Step 2** Click **Edit Settings**.
  - Step 3** Verify that **Enable SOCKS Proxy** is selected.
  - Step 4** Configure the basic and advanced SOCKS Proxy settings.

Property	Description
SOCKS Proxy	Enabled.
SOCKS Control Ports	Ports that accept SOCKS requests. Default is 1080.
UDP Request Ports	UDP ports on which the SOCKS server should listen. Default is 16000-16100.
Proxy Negotiation Timeout	Time to wait (in seconds) to send or receive data from a SOCKS client in the negotiation phase. Default is 60.
UDP Tunnel Timeout	Time to wait (in seconds) for data from a UDP client or server before closing the UDP tunnel. Default is 60.

### Go back to

- [How to Enable and Configure Processing of SOCKS Traffic, page 6-1](#)

## Creating SOCKS Policies

- 
- Step 1** Navigate to **Web Security Manager > SOCKS Policies**.
  - Step 2** Click **Add Policy**.
  - Step 3** Assign a name in the **Policy Name** field.



**Note** Each policy group name must be unique and only contain alphanumeric characters or the space character.

---

- Step 4** (Optional) Add a description.
- Step 5** In the **Insert Above Policy** field, choose where in the SOCKS policies table to insert this SOCKS policy. When configuring multiple SOCKS policies, determine a logical order for each policy. Carefully order your policies to ensure that correct matching occurs.
- Step 6** In the **Identities and Users** section, choose one or more Identities to apply to this policy group.
- Step 7** (Optional) Expand the Advanced section to define additional membership requirements.

Advanced Option	Description
Proxy Ports	<p>The port configured in the browser.</p> <p>Optionally, define policy group membership by the proxy port used to access the Web Proxy. Enter one or more port numbers in the Proxy Ports field. Separate multiple ports with commas.</p> <p>You might want to define policy group membership on the proxy port if you have one set of clients configured to explicitly forward requests on one port, and another set of clients configured to explicitly forward requests on a different port.</p> <p><b>Note:</b> If the Identity associated with this policy group defines Identity membership by this advanced setting, the setting is not configurable at the SOCKS policy group level.</p>
Subnets	<p>(Optional) Define policy group membership by subnet or other addresses.</p> <p>You can choose to use the <b>addresses</b> that may be <b>defined</b> with the associated <b>Identity</b>, or you can enter <b>specific addresses</b> here.</p> <p><b>Note:</b> If the Identity associated with this policy group defines its membership by addresses, then in this policy group you must enter addresses that are a subset of the Identity's addresses. Adding addresses in the policy group further narrows down the list of transactions that match this policy group.</p>
Time Range	<p>(Optional) Define policy group membership by time range:</p> <ol style="list-style-type: none"> <li>1. Select a time range from the <b>Time Range</b> field.</li> <li>2. Specify whether this policy group should apply to the times inside or outside the selected time range.</li> </ol> <p>For more information about creating time based policies, see <a href="#">Working with Time Based Policies, page 7-9</a>.</p> <p>For more information about creating time ranges, see <a href="#">Creating Time Ranges, page 7-9</a>.</p>

- Step 8** Submit and commit your changes.

# Logging

This section supplements [Chapter 24, “Logging”](#) with information specific to SOCKS traffic.

## Transaction Result Codes

Result Code	Description
UDP_MISS	The object was fetched from the origin server.

## Log Fields, Format Specifiers, and Field Values

W3C Log Field	Format Specifier	Field Value	Description
x-elapsed-time	%e	97	<p>Elapsed time in milliseconds.</p> <p>For TCP traffic, this is the time elapsed between the opening and closing of the HTTP connection.</p> <p>For UDP traffic, this is the time elapsed between the sending of the first datagram and the time at which the last datagram can be accepted. A large elapsed time value for UDP traffic may indicate that a large timeout value and a long-lived UDP association allowed datagrams to be accepted longer than necessary.</p>

# 7

## Policies

---

- [Overview of Policies, page 7-1](#)
- [Block Versus Allow Decisions, page 7-2](#)
- [Policy Types, page 7-2](#)
- [Working with Policy Groups, page 7-4](#)
- [Policy Group Membership, page 7-7](#)
- [Working with Time Based Policies, page 7-9](#)
- [Working with User Agent Based Policies, page 7-10](#)
- [Tracing Policies, page 7-12](#)

## Overview of Policies

Policies are the means by which you control transactions based on users, groups, and other criteria. Example policies:

- Users in the Marketing group can access a competitor's website, but other users cannot.
- Guest users on customer-facing machines, such as computers in a company store, cannot access banking sites, but employees can.
- No users can access gambling sites. Instead, when they try to view a gambling site, they see a web page that explains the organization's policies.
- All users trying to access a particular site that no longer exists are redirected to a different site.
- All users except those in IT are blocked from accessing potential malware sites, but users in IT can access them for testing purposes, and the downloaded content is scanned for harmful objects.
- All requests for streaming media are blocked during business hours, but allowed outside of business hours.
- All requests from a particular user agent, such as a software update program, are allowed without requiring authentication.
- Block uploads of all Excel spreadsheet files greater than 2 MB.
- Block uploads of data to sites with a bad web reputation.
- Block uploads of data infected with malware.

### Related topics

- [Policy Types, page 7-2.](#)
- [Working with Policy Groups, page 7-4.](#)
- [Tracing Policies, page 7-12.](#)

# Block Versus Allow Decisions

The Web Security appliance is permissive by default. That is, requests are allowed unless specifically blocked in a policy group.

## File Types

AsyncOS first looks at information in file headers to identify file types. If warranted, it then scans the file. If a header identifies a file as one type, for example a PDF, and then through scanning AsyncOS determines that the file is actually of another type, for example, an executable, AsyncOS blocks the transaction even if the actual file type is allowed by policy. It does this because the misidentification of file types indicates a possible security threat.

Policy	File Type (identified by header)	File Type (determined by scanning)	Result
Block file-type <i>X</i>	<i>X</i>	N/A (file not scanned)	Block
Allow file-type <i>X</i>	<i>X</i>	<i>X</i>	Allow
Allow file-type <i>X</i> and Allow file-type <i>Y</i>	<i>X</i>	<i>Y</i>	Block

## Policy Types

The Web Security appliance uses multiple types of policies to enforce organizational policies and requirements.

- **Identities.** “Who are you?”
- **Decryption Policies.** “To decrypt or not to decrypt?”
- **Routing Policies.** “From where to fetch content?”
- **Access Policies.** “To allow or block the transaction?”
- **Cisco IronPort Data Security Policies.** “To block the upload of data?” Cisco IronPort Data Security Policies actions are defined on the Web Security appliance.
- **External DLP (data loss prevention) Policies.** “To block the upload of data?” External DLP Policies actions are defined on an external DLP appliance.
- **Outbound Malware Scanning Policies.** “To block the upload of malicious data?”
- **SaaS Application Authentication Policies.** “To allow this user access to the SaaS application?”

You use the policies together to create the behavior you need or expect when clients access the web.

To define policies, you create policy groups. After you create policy groups, you can define the control settings for each group. For more information about working with policy groups, see [Working with Policy Groups, page 7-4](#).

All policy types have a global policy group that maintains default settings and rules that apply to web transactions not covered by another policy. For more information on global policies, see [Working with Policy Groups, page 7-4](#).

## Identities

An Identity is a policy that identifies the user making a request. This is the only policy where you can define whether or not authentication is required. An Identity addresses the question, “who are you?” However, Identities do *not* specify a list of users who are *authorized* to access the web. You specify authorized users in the other policy types after you specify the Identity to use.

All other policies you create must specify an Identity.

Configure Identities on the Web Security Manager > Identities page. For more information about Identities, see [Identities, page 8-1](#).

## Decryption Policies

Decryption Policies determine whether or not an HTTPS connection should be decrypted, passed through, or dropped. They address the question, “to decrypt or not to decrypt?”

The appliance uses Decryption Policies to evaluate HTTPS requests. The Decryption Policy group that applies to an HTTPS request determines whether the appliance drops the connection, passes it through without decryption, or decrypts the connection and subsequently evaluate the decrypted request and response against the defined Access Policy groups.

Configure Decryption Policy groups on the Web Security Manager > Decryption Policies page. For more information about Decryption Policy groups, see [Processing HTTPS Traffic, page 11-1](#).

## Routing Policies

Routing Policies determine to where to pass the client request, either to another proxy or to the destination server. They address the question, “from where to fetch content?”

You can use this policy type to select a group of upstream proxies configured for load balancing or failover.

Configure Routing Policies on the Web Security Manager > Routing Policies page. For more information about Routing Policies, see [Working with External Proxies, page 10-1](#).

## Access Policies

Access Policies determine whether to allow or block HTTP and decrypted HTTPS transactions. They address the question, “to allow or block the transaction?”

Access Policies determine how the appliance controls access to services, applications, and objects on the web for HTTP and decrypted HTTPS requests. The appliance uses Access Policies to evaluate and scan HTTP requests and HTTPS requests designated for decryption.

Configure Access Policy groups on the Web Security Manager > Access Policies page. For more information about Access Policy groups, see [Block, Allow or Redirect Transaction Requests, page 9-1](#).

## Cisco IronPort Data Security Policies

Cisco IronPort Data Security Policies determine whether or not to block a request to upload data using logic defined on the Web Security appliance. They address the question, “to block the upload of data?”

The Web Proxy uses Cisco IronPort Data Security Policies to evaluate and scan HTTP requests and decrypted HTTPS requests that have any data in the request body.

Configure Data Security Policy groups on the Web Security Manager > Cisco IronPort Data Security page. For more information about Data Security Policy groups, see [Data Security and External DLP Policies, page 13-1](#).

## External DLP Policies

External DLP (data loss prevention) policies determine whether or not to block a request to upload data using logic stored on an external DLP server. They address the question, “to block the upload of data?”

The Web Proxy uses External DLP Policies to evaluate HTTP requests and decrypted HTTPS requests that have any data in the request body and send them to an external DLP server for scanning.

Configure External DLP Policy groups on the Web Security Manager > External Data Loss Prevention page. For more information about External DLP Policy groups, see [Data Security and External DLP Policies, page 13-1](#).

## Outbound Malware Scanning Policies

Outbound Malware Scanning Policies determine whether or not to block a request to upload data that contains malicious data. They address the question, “To block the upload of malicious data?”

The Web Proxy uses Outbound Malware Scanning Policies to scan for malware HTTP requests and decrypted HTTPS requests that have any data in the request body.

Configure Outbound Malware Scanning Policy groups on the Web Security Manager > Outbound Malware Scanning page. For more information about Outbound Malware Scanning Policy groups, see [Outbound Malware Scanning, page 12-1](#).

## SaaS Application Authentication Policies

SaaS Application Authentication Policies determine whether or not a user is allowed access to a Software as a Service (SaaS) application. They address the question, “to allow this user access to a SaaS application?”

SaaS Application Authentication Policies determine how the appliance controls user access to configured SaaS applications, such as WebEx. When you enable Cisco SaaS Access Control, users log into the configured SaaS applications using their network authentication user credentials. That means they use the same user name and password for all SaaS applications as well as network access.

Configure SaaS Application Authentication Policy groups on the Web Security Manager > SaaS Policies page. For more information about SaaS Application Authentication Policy groups, see [Controlling Access to SaaS Applications, page 15-1](#).

## Working with Policy Groups

A policy group is an administrator defined configuration that allows you to apply acceptable use policies to specific categories of users. After you create policy groups, you can define the control settings for each group.



You can create as many user defined policy groups as required to enforce the proper access control. The Web Security appliance displays policy groups together in a policies table.

All policies have a default, global policy group that applies to a transaction if none of the user defined policy groups apply. A global policy group maintains default settings and rules that apply to web transactions not covered by another policy. This group appears in the last row of a policies table, and the Web Proxy applies its rules last if no other matching occurs.

## Creating Policy Groups

You can create policy groups based on combinations of several criteria, such as client subnet or the URL category of the destination site. You must define at least one criterion for policy group membership. When you define multiple criteria, the client request must meet all criteria to match the policy group.

Options used to configure policy groups allow you to specify exceptions to global policy settings and control access to services for groups of users.

For more information about creating policy groups for the different policy types, see the following locations:

- [Creating Identities, page 8-18](#)
- [Creating Access Policies, page 9-5](#)
- [Creating Decryption Policies, page 11-16](#)
- [Creating Routing Policies, page 10-5](#)
- [Creating Data Security and External DLP Policies, page 13-6](#)

## Using the Policies Tables

The policies table is an ordered list of policy groups and the settings you configure for each filtering component. It displays policy groups by row and control settings by column. The control settings you can define vary by policy type.

Figure 7-1 on page 7-5 shows the Access Policies table.

**Figure 7-1 Access Policies Table**

Access Policies

Policies							
Add Policy...							
Order	Group	Protocols and User Agents	URL Filtering	Applications	Objects	Web Reputation and Anti-Malware Filtering	Delete
1	ExampleAP1 Identity: TestLab	(global policy)	(global policy)	(global policy)	(global policy)	(global policy)	🗑️
2	ExampleAP2 Identity: NTLMUsers	(global policy)	(global policy)	(global policy)	(global policy)	(global policy)	🗑️
	<b>Global Policy</b> Identity: All	No blocked items	Monitor: 66	Monitor: 19	No blocked items	Web Reputation: Enabled Webroot: Enabled McAfee: Disabled Sophos: Enabled	Policy Disabled

Click to edit user defined policy group membership.      Global policy group (not editable).      Click to customize policy control settings.

Figure 7-2 shows the Decryption Policies table.

Figure 7-2 Decryption Policies Table

Decryption Policies

Order	Group ?	URL Categories	Web Reputation	Default Action	Delete
1	ExampleDP1 Identity: NTLMUsers	(global policy)	(global policy)	(global policy)	
	<b>Global Policy</b> Identity: All	Monitor: 66	Enabled	Decrypt	

Policy Disabled

*(When enabled, authentication is applicable to forward connections and pre-established transparent IP-based credentials only.)*

Click to edit user defined policy group membership.      Global policy group (not editable).      Click to customize policy control settings.

Any policy group that you create is added as a new row in the policies table. New policy groups inherit global policy settings for each control setting until you override them. To edit policy groups, click the links in each row.

When you create or configure a policy group, you define the following components:

- **Policy group membership.** Define how to group users that belong to the policy group. For user defined policy groups, you can group by different properties, such as client IP address, authentication group or user name, or URL category. The properties you can define for a policy depends on the policy type.

Click the policy group name to edit the group membership requirements, such as client IP address and authentication requirements. A page is displayed where you can configure membership requirements.



**Note** For global policies, you can only define the membership requirements for the global Identity group and not for the global Access, Decryption, or Routing groups. Global Access, Decryption, and Routing groups always match all Identities.

For more information about policy group membership, see [Policy Group Membership, page 7-7](#).

- **Policy group control settings.** Define how users in the group can use the Internet. The control settings you can define depend on the policy type. For example, for Routing Policies, you define from which proxy group to fetch the content, and for Access Policies, you can use the Web Security appliance features, such as Web Reputation, anti-malware scanning, and more to determine whether or not to allow the client request.

Click the link in the policy group row under the control setting you want to configure, such as URL Categories or Routing Destination. When you click a link in the table, a page is displayed where you can configure settings for that policy group.

For more information on configuring control settings for each policy type, see the following sections:

- [Controlling HTTP and Native FTP Traffic, page 9-8](#)
- [Controlling HTTPS Traffic, page 11-20](#)
- [Creating Routing Policies, page 10-5](#)
- [Controlling Upload Requests Using Cisco IronPort Data Security Policies, page 13-9](#)
- [Controlling Upload Requests Using External DLP Policies, page 13-16](#)

# Policy Group Membership

All policy groups define which transactions apply to them. When a client sends a request to a server, the Web Proxy receives the request, evaluates it, and determines to which policy group it belongs. The Web Proxy applies the configured policy control settings to a client request based on the client request's policy group membership.

Transactions belong to a policy group for each type of policy that is enabled. If a policy type has no user defined policy groups, then each transaction belongs to the global policy group for that policy type.

Policy group membership for a Routing, Decryption, Access, Data Security, and External DLP Policies is based on an Identity and optional additional criteria. That means that *the Web Proxy evaluates Identity groups before the other policy types*. The Web Security appliance allows you to define some membership criteria at either the Identity level or the non-Identity policy level. For more information, see [Policy Group Membership Rules and Guidelines, page 7-8](#).

Suppose you define an Identity by subnet 10.1.1.0/24 and then create an Access Policy using that Identity. The Access Policy membership applies to all IP addresses specified in the Identity by default. You can then choose to configure the Access Policy membership so that it applies to a subset of the addresses defined in the Identity, such as addresses 10.1.1.0-15.

For more information defining membership for each policy type, see the following sections:

- [Evaluating Identity Group Membership, page 8-4](#)
- [Evaluating Access Policy Group Membership, page 9-4](#)
- [Evaluating Decryption Policy Group Membership, page 11-14](#)
- [Evaluating Routing Policy Group Membership, page 10-4](#)
- [Evaluating Data Security and External DLP Policy Group Membership, page 13-4](#)

## Authenticating Users versus Authorizing Users

The Web Security appliance separates where it authenticates users from where it authorizes users.

*Authentication* is the mechanism by which the Web Proxy securely identifies a user. It answers the following questions:

- Who is the user?
- Is the user really whom he/she claims to be?

*Authorization* is the mechanism by which the Web Proxy determines the level of access the user has to the World Wide Web. It answers the following questions:

- Is this user allowed to view this website?
- Is this user allowed to connect to this HTTPS server without the connection being decrypted?
- Is this user allowed to directly connect to the web server, or must it connect to another proxy server first?
- Is this user allowed to upload this data?

The Web Proxy can only authorize a user to access an Internet resource *after* it authenticates who the user is. The Web Proxy authenticates users when it evaluates Identity groups, and it authorizes users when it evaluates all other policy group types. What that means is the Identity group indicates who is making the request, but does not indicate whether that client is allowed to make the request.

By separating authentication from authorization, you can create a single Identity group that identifies a group of users and then you can create multiple policy groups that allow different levels of access to subsets of users in the group in the Identity.

For example, you can create one Identity group that covers all users in an authentication sequence. Then you can create an Access Policy group for each authentication realm in the sequence. You can also use this Identity to create one Decryption Policy with the same level of access for all users in the Identity.

## Working with Failed Authentication and Authorization

You can allow users another opportunity to access the web if they fail authentication or authorization. How you configure the Web Security appliance depends on what fails:

- **Authentication.** When authentication fails, you can grant guest access to the user. Authentication might fail under the following circumstances:
  - A new hire has been provided credentials in an email but they are not yet populated in the authentication server.
  - A visitor comes to the office and needs to be granted restrictive Internet access, but is not in the corporate user directory.

For more information on configuring guest access, see [Allowing Guest Access to Users Who Fail Authentication, page 8-10](#).

- **Authorization.** A user might authenticate correctly, but not be granted access to the web due to the applicable Access Policy. In this case, you can allow the user to re-authenticate with more privileged credentials. To do this, enable the “Enable Re-Authentication Prompt If End User Blocked by URL Category or User Session Restriction” global authentication setting. For more information, see [Allowing Users to Re-Authenticate, page 20-25](#).

## Working with All Identities

You can create a policy group that specifies “All Identities” as the configured Identity group. “All Identities” applies to every valid client request because by definition, every request either succeeds and has a user defined or global Identity assigned to it or is terminated because it fails authentication (and no guest access was provided for users failing authentication).

When you create a policy group that uses All Identities, you must configure at least one advanced option to distinguish the policy group from the global policy group.

Typically, you use All Identities in a policy while also configuring an advanced option, such as a particular user agent or destination (using a custom URL category). This allows you to create a single rule that makes an exception for a specific case instead of creating multiple rules to make the exception for the specific case. For example, you can create an Access Policy group whose membership applies to All Identities and a custom URL category for all intranet pages. Then you can configure the Access Policy control settings to disable anti-malware filtering and Web Reputation scoring.

## Policy Group Membership Rules and Guidelines

Consider the following rules and guidelines when defining policy group membership:

- The Web Proxy evaluates Identity groups before the other policy types.
- Subnet membership criteria defined in the Identity group can be further narrowed down in the policy group using the Identity group.

- Advanced membership criteria (proxy ports, URL categories, and user agents) defined in the Identity group cannot be defined in the policy group using the Identity group.
- Define Identity groups as broadly as possible. Then you can use the Identity groups in other policy types and further narrow down membership as necessary.
- Define fewer, more generic Decryption and Routing Policies as much as possible.
- If you need to define membership by URL category, only define it in the Identity group when you need to exempt from authentication requests to that category. For other purposes, define membership by URL category in the Access, Decryption, Routing, Data Security, or External DLP Policy group. This can increase performance in most cases.

## Working with Time Based Policies

The Web Security appliance provides the means to create time based policies by specifying time ranges, such as business hours, and using those time ranges to define access to the web. You can define policy group membership based on time ranges, and you can specify actions for URL filtering based on time ranges.

You might want to use time ranges to accomplish the following tasks:

- You can block access to high bandwidth sites, such as streaming media, or distracting sites, such as games, during business hours.
- You can route transactions to a particular external proxy after midnight when the other proxies are being serviced.
- You can allow larger files to be downloaded on the weekends.

Define time ranges on the Web Security Manager > Defined Time Ranges page. You can create time ranges to define concepts such as “business hours” or “weekend shift.” Then you can use the time ranges in the following locations:

- Policy group membership for a Routing, Access, or Decryption Policy.
- URL filtering settings for Access Policies.

When you define a time range, you can specify the day(s) of the week and the time of day. A transaction matches the time range when it occurs on one of the days specified and during the time specified. You can also define multiple combinations of day and time in a single time range. For example, you can define a time range that applies to transactions that occur on Monday through Friday from 08:00 to 17:00 or on Saturday from 09:00 to 13:00.

Policies and URL filtering actions can be defined inside or outside the defined time ranges.



### Note

Because you can define time based policy group membership only for Routing, Access, and Decryption Policies, but not Identities, you cannot create time based policies that define when users must authenticate. Authentication requirements are defined in Identity groups, but time based policies are defined in other policy group types. (bug #41723)

## Creating Time Ranges

- Step 1** Go to Web Security Manager > Defined Time Ranges.
- Step 2** Click **Add Time Range**.

- Step 3** In the Time Range Name field, enter a unique, descriptive name.
- Step 4** In the Time Zone section, choose whether to use the time zone setting on the Web Security appliance or a different time zone setting you configure.
- Step 5** In the Time Values section, define at least one row that specifies the days of the week and time of day to include in this time range.
- In the Day of the Week section, select at least one day.
  - In the Time of Day section, choose All Day or enter a time range in the day using the From and To fields.

Each time range includes the start time and excludes the end time. For example, entering 8:00 through 17:00 matches 8:00:00 through 16:59:59, but not 17:00:00.

Midnight must be specified as 00:00 for a start time, and as 24:00 for an end time.



**Note** A transaction must occur on the day *and* in the time specified to match a row in the Time Values section. That means the Day of Week and Time of Day values have an “AND” relationship with each other within a single row.

- Step 6** Optionally, you can create additional time value rows by clicking **Add Row**.



**Note** When a time range includes multiple time value rows, a transaction can occur within any of the defined time values to match the time range. That means that multiple time value rows in a single time range have an “OR” relationship with each other.

- Step 7** Submit and commit your changes.

## Working with User Agent Based Policies

The Web Security appliance provides the means to create policies to define access to the web by the client application (user agent), such as a web browser, making the client request. You can define policy group membership based on user agents, and you can specify control settings based on user agents.

You might want to specify user agents to accomplish the following tasks:

- You can exempt certain user agents from authentication. You might want to do this for client applications that cannot handle prompting users for authentication credentials. For more information about how to do this, see [Exempting User Agents from Authentication, page 7-12](#).
- You can block access from particular user agents that you define.

You can configure user agents in the following locations:

- Policy group membership for all policy types, including Identities.
- Application control settings for Access Policies.



**Note** When the appliance is deployed in transparent mode, user agent information is not available for Decryption Policies.

## Configuring User Agents for Policy Group Membership

When you define policy group membership for any policy type, you can expand the Advanced section to define membership by additional criteria, such as user agent. When you click the User Agents link, the Membership by User Agent page appears allowing you to define membership by user agent.

Figure 7-3 on page 7-11 shows the Membership by User Agent page for an Identity policy group.

**Figure 7-3** Defining Policy Group Membership by User Agent

Identities: Policy "New Policy": Membership by User Agent

On this page, you can select as many user agents as desired. The web interface includes some of the more common user agents that you can select using a check box. You can also type a regular expression to define any user agent necessary.

For each user agent you select in the Common User Agents section, AsyncOS for Web creates a regular expression to define the user agent. However, if you select the Any Versions option for each browser type, AsyncOS for Web creates a single regular expression that represents all versions of that browser instead an expression for each version. Creating one regular expression instead of multiple increases performance.

For example, when you select “Version 2.X” and “Version 1.X or earlier” for Firefox, AsyncOS for Web uses the following regular expressions:

```
Firefox/2
Firefox/1
```

However, when you select “Firefox Any Versions,” AsyncOS uses the following regular expression:

```
Firefox
```

Also, you can configure the policy group membership to either match the user agents you define, or matching all other user agents than the ones defined.

## Exempting User Agents from Authentication

---

**Step 1** Create an Identity policy group with membership that is based on the user agent to exempt.



**Note** Do not require authentication for the Identity policy group.

---

For more information about creating Identities, see [Creating Identities, page 8-18](#).

**Step 2** Place the Identity policy group above all other Identity policy groups that require authentication.

**Step 3** Submit and commit your changes.

---

## Tracing Policies

The Web Security appliance web interface includes a tool that traces a particular client request and details how the Web Proxy processes the request. The Web Proxy evaluates the request against all committed Access, Decryption, Cisco IronPort Data Security, Outbound Malware Scanning, and Routing Policies and calculates other attributes, such as the web reputation score.

The policy trace tool allows administrators to troubleshoot when end users ask questions about Web Proxy behavior. It simulates client requests as if they were made by the end users and describes Web Proxy behavior. It can be a powerful troubleshooting or debugging tool, especially if you have combined many of the advanced features available on the Web Security appliance.

When you use the policy trace tool, the Web Proxy does not record the requests in the access log or reporting database.

By default, the Web Proxy simulates an HTTP GET request. However, when you specify a file to upload in the Request Details section, the Web Proxy simulates an HTTP POST request.



**Note** The policy trace tool explicitly makes requests even if the Web Security appliance is deployed in transparent mode.

---

You can trace policies on the System Administration > Policy Trace page.

---

**Step 1** Navigate to the System Administration > Policy Trace page.

**Step 2** In the URL field, enter the URL in the client request to simulate.

**Step 3** Optionally, in the Client IP Address field, enter the IP address of the machine to simulate.



**Note** If no IP address is specified, AsyncOS uses localhost.

---

**Step 4** Optionally, you can simulate an authentication user by entering the following authentication requirements in the User area:

- **User Name.** Enter the user name of the authentication user.
- **Authentication Realm.** Choose an authentication realm.





**Note** For authentication to work for the user you enter here, the user must have already successfully authenticated through the Web Security appliance.

**Step 5** Optionally, by expanding the Advanced section, you can configure additional settings to simulate a more specific user request that you want to trace.

The Advanced settings are divided into details of the transaction request to simulate and transaction response details to override.

**Step 6** Configure the transaction request information to simulate as desired. [Table 7-1](#) describes the request side advanced settings you can configure.

**Table 7-1 Policy Trace Advanced Settings for Requests**

Setting	Description
Proxy Port	Select a specific proxy port to use for the trace request to test policy group membership based on proxy port.
User Agent	Specify the user agent to simulate in the request.
Time of Request	Specify the day of week and time of day to simulate in the request.
Upload File	Choose a local file to simulate uploading in the request. When you specify a file to upload here, the Web Proxy simulates an HTTP POST request instead of a GET request.
Object Size	Enter the size of the request object in bytes. You can enter K, M, or G to represent Kilobytes, Megabytes, or Gigabytes.
MIME Type	Enter the MIME type.
Anti-malware Scanning Verdicts	Choose whether or not to override the Webroot, McAfee, or Sophos scanning verdicts.

**Step 7** Optionally, configure transaction response overrides using the reference information in [Table 7-2](#). You might want to override a transaction response detail to simulate how a different response value, such as a lower web reputation score, would affect the policies assigned to the transaction.

**Table 7-2 Policy Trace Advanced Settings for Response Overrides**

Setting	Description
URL Category	Choose whether or not to override the URL category of the transaction response.
Application	Choose an application that the Application Visibility and Control engine can detect.
Object Size	Enter the size of the response object in bytes. You can enter K, M, or G to represent Kilobytes, Megabytes, or Gigabytes.
MIME Type	Enter the MIME type.
Web Reputation Score	Enter the web reputation score from -10.0 to 10.0.
Anti-malware Scanning Verdicts	Choose whether or not to override the Webroot, McAfee, or Sophos scanning verdicts.

**Step 8** Click **Find Policy Match**.

The policy trace tool displays the results in the Results area.

---

# 8

## Identities

---

- [Overview of Identities, page 8-1](#)
- [Evaluating Identity Group Membership, page 8-4](#)
- [Matching Client Requests to Identity Groups, page 8-8](#)
- [Allowing Guest Access to Users Who Fail Authentication, page 8-10](#)
- [Identifying Users Transparently, page 8-12](#)
- [Creating Identities, page 8-18](#)
- [Configuring Identities in Other Policy Groups, page 8-22](#)
- [Example Identity Policies Tables, page 8-23](#)

## Overview of Identities

Identities serve these purposes:

- Group transaction requests for the application of policies.
- Specify identification or authentication needs for members of the identify group.

AsyncOS assigns an identity to every transaction it processes. A global identity applies to all transactions that do not qualify for membership in a user-defined identity. The identities you create are also available for use in configuring access policies (including SOCKS policies) and decryption policies.

Example of how AsyncOS processes transactions:

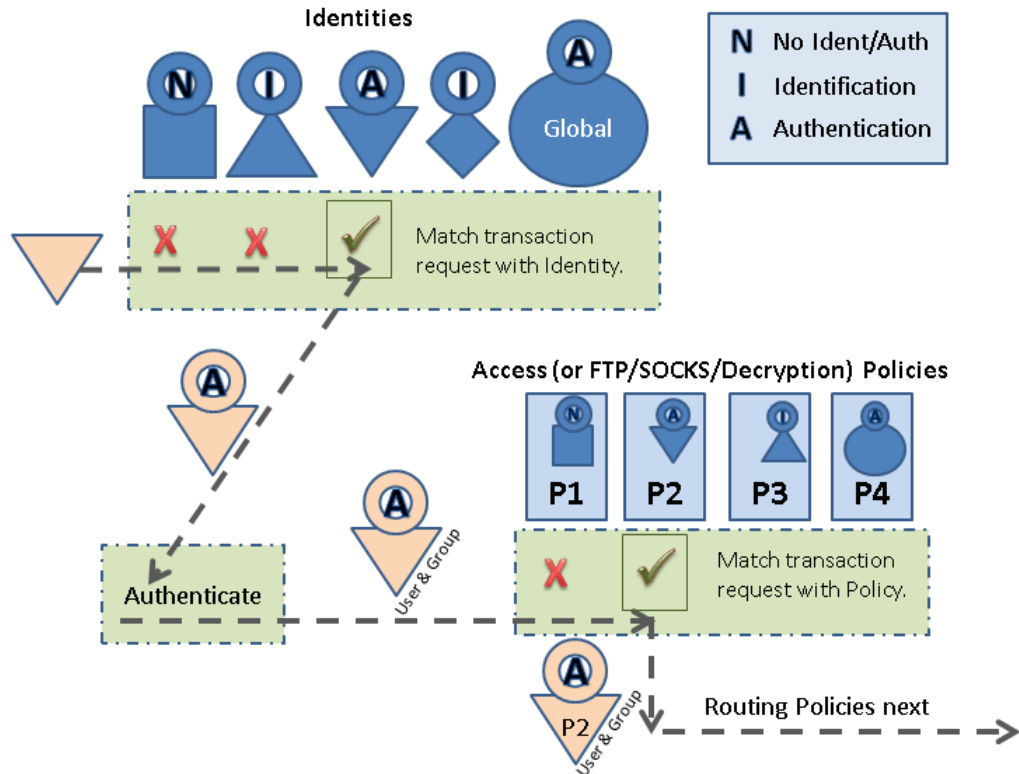

These transaction characteristics are available to define an identity group:

- Subnet — The subnet of the client making the transaction request.
- Protocol — The protocol that the requested transaction will use.
- Port — The port on which the client makes the request.



**Note** Defining identities by port works best when the appliance is deployed in explicit forward mode or when clients explicitly forward requests to the appliance. Defining identities by port when client requests are transparently redirected to the appliance may result in erroneous denial of some requests.

- User agent — The user agent (client application) making the request, for example, Internet Explorer or FireFox.
- URL category — The URL category associated with the URL requested by the client.

Examples:

- An identity could be used for requests coming from user agents that do not support authentication.
- An identity could be used for transaction requests for social networking sites initiated by clients on a particular subnet.

Example of Identities flow:

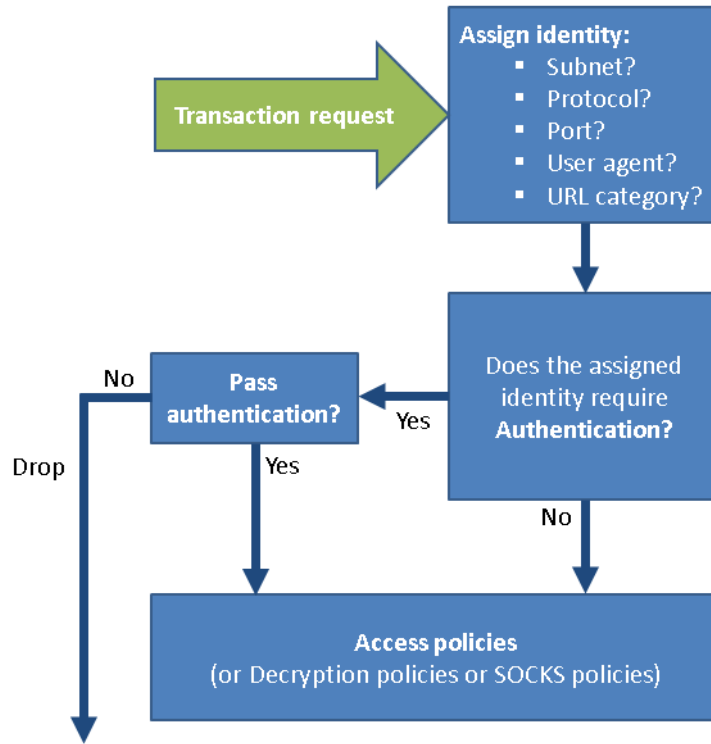

You can use the identities you create as a membership requirement for Access policies (including SOCKS policies) and Decryption policies. For example, if you know that end users want to use XYZ application, which accesses help files at XYZ domain and does not require or support authentication, you might create an identify for XYZ application (the user agent). The identity for XYZ does not require authentication. In addition, you can create an access policy that defines transactions with XYZ identity as group members and only allows access to URLs within the XYZ domain.

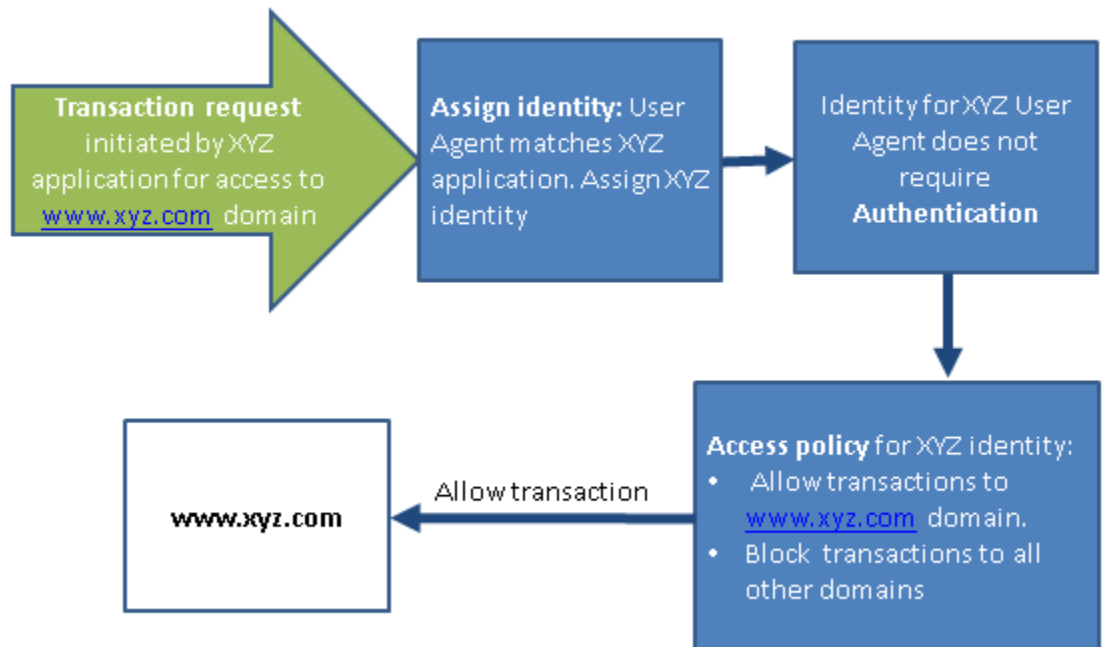

You might want to group the following types of users or machines:

- **A group of machine addresses in a test lab.** You can create a Routing Policy with this Identity so requests from these machines are fetched directly from the destination server.
- **All authenticated users based on the All Realms authentication sequence.** You can create a single Access Policy using this Identity, or you can create a different Access Policy for each authentication realm and configure different control settings for users in each realm.
- **Users accessing the Web Security appliance on a particular proxy port.** You can create a Routing Policy using this Identity that fetches content from a particular external proxy for requests that explicitly connect to the appliance on a particular proxy port.
- **All subnets trying to access a website in a user defined URL category do not require authentication.** You can create an Access Policy using this Identity to exempt requests to particular destinations from authentication. You might want to do this for Windows update servers.

Define Identities on the Web Security Manager > Identities page. For more information about creating Identities, see [Creating Identities, page 8-18](#).

## Evaluating Identity Group Membership

When a client sends a request to a server, the Web Proxy receives the request, evaluates it, and determines to which Identity group it belongs.

To determine the Identity group that a client request matches, the Web Proxy follows a very specific process for matching the Identity group membership criteria. During this process, it considers the following factors for group membership:

- **Subnet.** The client subnet must match the list of subnets in a policy group.
- **Protocol.** The protocol used in the transaction, either HTTP, HTTPS, SOCKS, or native FTP.
- **Port.** The proxy port of the request must be in the Identity group's list of ports, if any are listed. For explicit forward connections, this is the port configured in the browser. For transparent connections, this is the same as the destination port.

You might want to define Identity group membership on the proxy port if you have one set of clients configured to explicitly forward requests on one port, and another set of clients configured to explicitly forward requests on a different port.

- **User agent.** The user agent making the request must be in the Identity group's list of user agents, if any are listed. You might want to group by user agent for user agents that cannot handle authentication and you want to create an Identity that does not require authentication.
- **URL category.** The URL category of the request URL must be in the Identity group's list of URL categories, if any are listed. You might want to group by URL destination category if you create different authentication groups based on URL categories and want to apply them to users depending on the website categorization.
- **Authentication requirements.** If the Identity group requires authentication, the client authentication credentials must match the Identity group's authentication requirements. For more information about how authentication works with Identity groups, see [Understanding How Authentication Affects Identity Groups, page 8-5](#).

The information in this section gives an overview of how the appliance matches client requests to Identity groups. For more details on exactly how the appliance matches client requests, see [Matching Client Requests to Identity Groups, page 8-8](#).

The Web Proxy sequentially reads through each Identity group in the Identity policies table. It compares the client request status to the membership criteria of the first Identity group. If they match, the Web Proxy assigns the Identity group to the transaction.

If they do not match, the Web Proxy compares the client request to the next Identity group. It continues this process until it matches the client request to a user defined Identity group, or if it does not match a user defined Identity group, it matches the global Identity policy. When the Web Proxy matches the client request to an Identity group or the global Identity policy, it assigns the Identity group to the transaction.

If at any time during the comparison process the user fails authentication, the Web Proxy terminates the request. For more information about how authentication works with Identity groups, see [Understanding How Authentication Affects Identity Groups, page 8-5](#).

After the Web Proxy assigns an Identity to a client request, it evaluates the request against the other policy group types. For more information, see the following locations:

- [Evaluating Access Policy Group Membership, page 9-4](#)
- [Evaluating Decryption Policy Group Membership, page 11-14](#)
- [Evaluating Routing Policy Group Membership, page 10-4](#)
- [Evaluating Data Security and External DLP Policy Group Membership, page 13-4](#)

## Understanding How Authentication Affects Identity Groups

To define authentication requirements for an Identity group, you can choose an authentication realm or sequence that applies to the Identity group.



### Note

---

You can specify the authorized users when you use the Identity in a non-Identity policy group.

---

Consider the following rules and guidelines when creating and ordering Identity groups:

- **Identity group order.** All Identity groups that do not require authentication must be above Identity groups that require authentication.
- **Cookie-based authentication.** When the appliance is configured to use cookie-based authentication surrogates, it does not get cookie information from clients for HTTPS and FTP over HTTP requests. Therefore, it cannot get the user name from the cookie. How HTTPS and FTP over HTTP requests are matched against the Identity groups varies based on other factors. For more information, see [Understanding How Authentication Affects HTTPS and FTP over HTTP Requests, page 8-6](#).
- **Identity uniqueness.** Verify the Identity group membership requirements are unique for each Identity group. If two Identity groups require the exact same membership, then client requests never match the lower Identity group. If any non-Identity policy uses the lower Identity group, client requests never match that policy.
- **Global Identity policy.** The global Identity policy does not require authentication by default when you create an authentication realm. If you want the global Identity policy to require authentication, you must assign an authentication realm, authentication sequence, or the All Realms sequence to the global Identity policy.

For some examples of how the Web Proxy matches client requests to an Identity group for different Identity policies tables, see [Example Identity Policies Tables, page 8-23](#).

## Understanding How Authentication Affects HTTPS and FTP over HTTP Requests

How the Web Proxy matches HTTPS and FTP over HTTP requests with Identities depends on the type of request (either explicitly forwarded or transparently redirected to the Web Proxy) and the authentication surrogate type:

- **No authentication surrogates.** The Web Proxy matches HTTPS and FTP over HTTP requests with Identity groups the same way it matches HTTP requests. For a diagram of how this occurs, see [Figure 8-1 on page 8-9](#).
- **IP-based authentication surrogates and explicit requests.** The Web Proxy matches HTTPS and FTP over HTTP requests with Identity groups the same way it matches HTTP requests. For a diagram of how this occurs, see [Figure 8-1 on page 8-9](#).
- **IP-based authentication surrogates and transparent requests.** The Web Proxy matches FTP over HTTP requests with Identity groups the same way it matches HTTP requests. But for HTTPS requests, the behavior is different, depending on whether or not the HTTPS request comes from a client that has authentication information available from an earlier HTTP request:
  - **Information available from a previous HTTP request.** The Web Proxy matches HTTPS requests with Identity groups the same way it matches HTTP requests. HTTPS requests are treated with the Identity associated with the IP address.
  - **No information available from a previous HTTP request.** When the Web Proxy has no credential information for the client, then it either fails the HTTPS request or decrypts the HTTPS request in order to authenticate the user, depending on how you configure the HTTPS Proxy. Use the HTTPS Transparent Request setting on the Security Services > HTTPS Proxy page to define this behavior.

For a diagram of how this occurs, see [Figure 8-1 on page 8-9](#).

- **Cookie-based authentication surrogates and transparent requests.** When the appliance uses cookie-based authentication, the Web Proxy does not get cookie information from clients for HTTPS and FTP over HTTP requests. Therefore, it cannot get the user name from the cookie. In this situation, HTTPS and FTP over HTTP requests still match the Identity group according to the other membership criteria, but the Web Proxy does not prompt clients for authentication *even if the Identity group requires authentication*. Instead, the Web Proxy sets the user name to NULL and considers the user as *unauthenticated*. Then, when the unauthenticated request is evaluated against the non-Identity policy groups, it matches only non-Identity groups that specify “All Identities” and apply to “All Users.” Typically, this is the global policy, such as the global Access Policy. For a diagram of how this occurs, see [Figure 8-2 on page 8-10](#).
- **Cookie-based authentication surrogates and explicit requests.** The behavior is different, depending on whether or not credential encryption is enabled:
  - **Credential encryption enabled.** The behavior is the same as cookie-based authentication with transparent requests, as described previously. See also [Accessing HTTPS and FTP Sites with Credential Encryption Enabled, page 20-24](#).
  - **Credential encryption disabled.** The Web Proxy uses no surrogates. HTTPS and FTP over HTTP requests are authenticated and matched to Identity groups like HTTP requests. For a diagram of how this occurs, see [Figure 8-1 on page 8-9](#).



Table 8-1 summarizes the previous information.

**Table 8-1** *Matching HTTPS and FTP over HTTP Requests to Identities*

Surrogate Types	Explicit Requests	Transparent Requests
No Surrogate	HTTPS and FTP over HTTP requests are matched like HTTP requests.	N/A
IP-based	HTTPS and FTP over HTTP requests are matched like HTTP requests.	<p>FTP over HTTP requests are matched like HTTP requests.</p> <p>HTTPS requests are matched like HTTP requests under any of the following conditions:</p> <ul style="list-style-type: none"> <li>• A previous HTTP request was authenticated using an identity with an IP-based surrogate.</li> <li>• A previous HTTP request was not authenticated, but the HTTPS Proxy is configured to decrypt the first HTTPS request.</li> </ul> <p>Otherwise, if a previous HTTP request was not authenticated and the HTTPS Proxy is configured to deny the request, the HTTPS request fails.</p>
Cookie-based	<p>The client is not prompted for authentication.</p> <p><b>Note:</b> When credential encryption is disabled, no surrogates are used, and HTTPS requests are matched like HTTP requests.</p>	The client is not prompted for authentication.

## Understanding How Authentication Scheme Affects Identity Groups

You define the authentication scheme for each Identity group, not at each realm or sequence. That means you can use the same NTLM realm or a sequence that contains an NTLM realm and use it in Identity groups that use either the NTLMSSP, Basic, or “Basic or NTLMSSP” authentication schemes.

The Web Proxy communicates which scheme(s) it supports to the client application at the beginning of a transaction. The Identity group currently in use determines which scheme(s) it supports. When the Web Proxy informs the client application that it supports both Basic and NTLMSSP, the client application chooses which scheme to use in the transaction.

Some client applications, such as Internet Explorer, always choose NTLMSSP when given a choice between NTLMSSP and Basic. This might cause a user to not pass authentication when all of the following conditions are true:

- The Identity group uses a sequence that contains both LDAP and NTLM realms.
- The Identity group uses the “Basic or NTLMSSP” authentication scheme.

- A user sends a request from an application that chooses NTLMSSP over Basic.
- The user only exists in the LDAP realm.

When this happens, the Web Proxy uses the NTLMSSP scheme to authenticate users in this Identity group because the client requests it. However, LDAP servers do not support NTLMSSP, so no user that exists only in the specified LDAP server(s) can pass authentication in this Identity group.

Therefore, when you need to use an authentication sequence that contains both LDAP and NTLM realms, consider the client applications that might try to access a URL when you configure the authentication scheme for an Identity group. For example, you might want to choose Basic as the only authentication scheme for an Identity group in some cases.

## Matching Client Requests to Identity Groups

[Figure 8-1 on page 8-9](#) shows how the Web Proxy evaluates a client request against the Identity groups when the Identity is configured to use:

- No authentication surrogates
- IP addresses as authentication surrogates
- Cookies as authentication surrogates with transparent requests
- Cookies as authentication surrogates with explicit requests and credential encryption is enabled

[Figure 8-2 on page 8-10](#) shows how the Web Proxy evaluates a client request against the Identity groups when the Identity is configured to use cookies as the authentication surrogates, credential encryption is enabled, and the request is explicitly forwarded.

Figure 8-1 Policy Group Flow Diagram for Identities - No Surrogates and IP-Based Surrogates

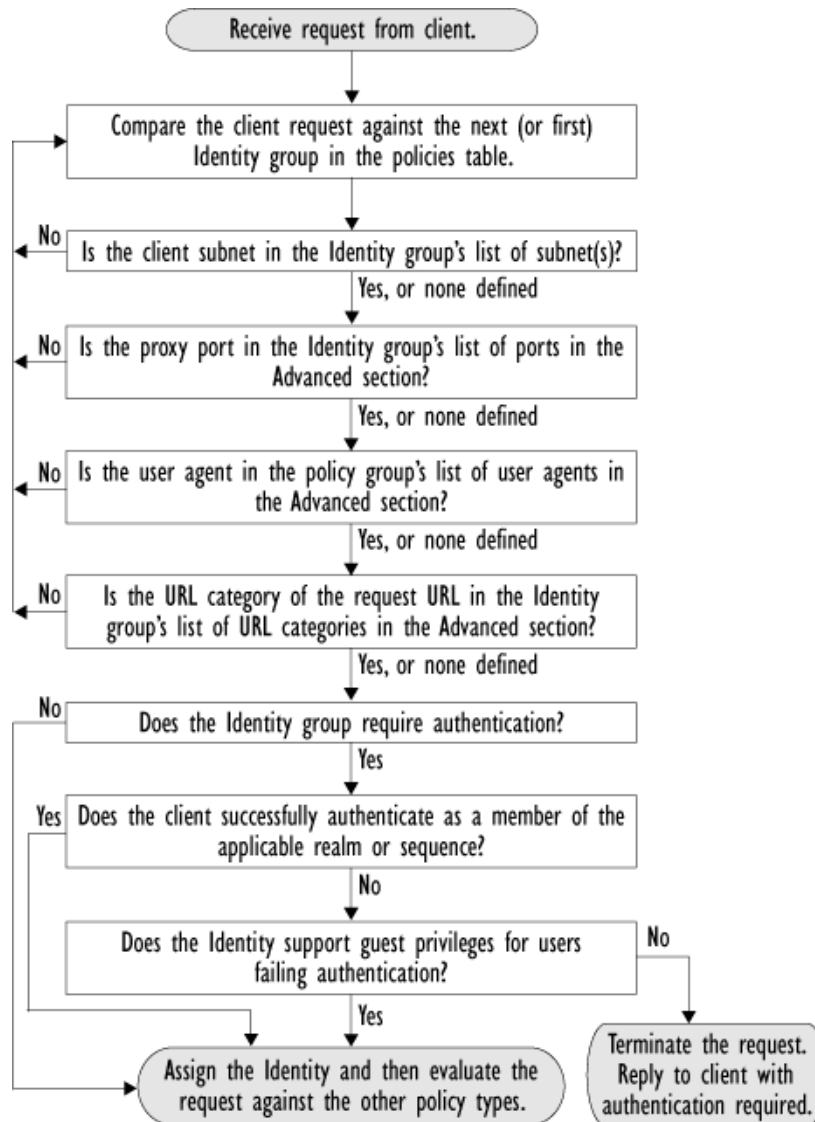
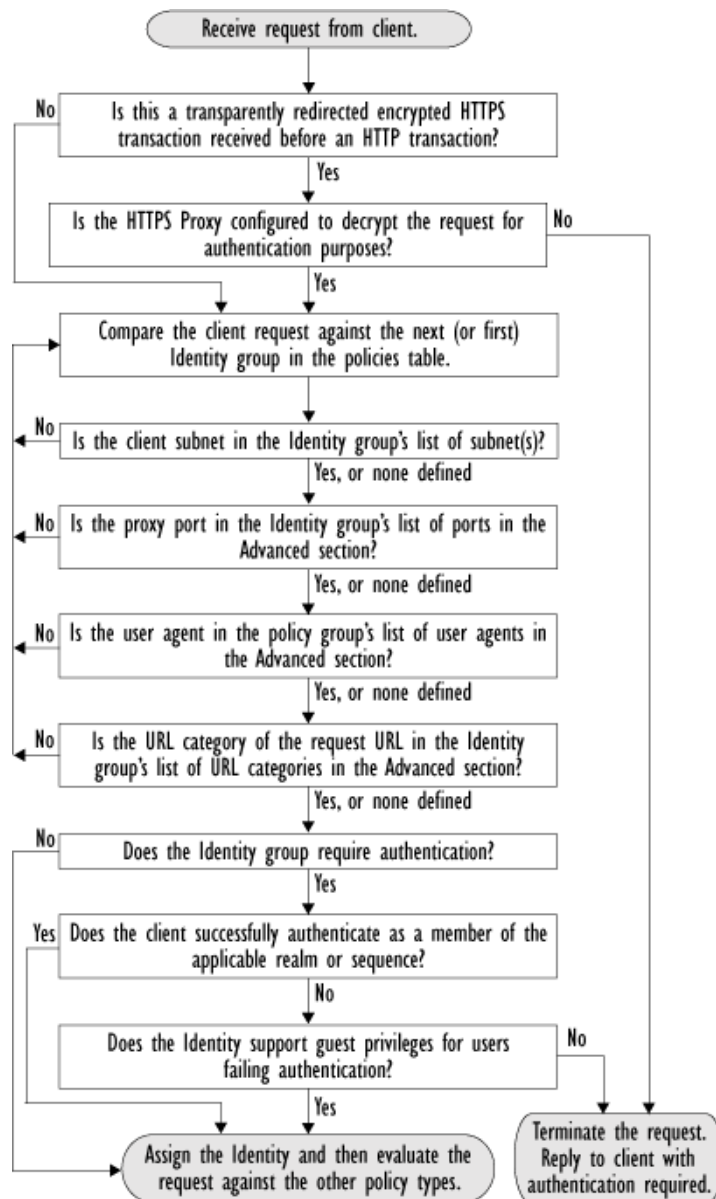

Figure 8-2 Policy Group Flow Diagram for Identities - Cookie-Based Surrogates



## Allowing Guest Access to Users Who Fail Authentication

You can grant limited access to users who fail authentication due to invalid credentials. By default, when a client passes invalid authentication credentials, the Web Proxy continually requests valid credentials, essentially blocking access to all Internet resources. However, when you allow guest access, the first time the client passes invalid authentication credentials, the user is treated as a guest and the Web Proxy does not request authentication again.

You might want to grant guest access to users in the following situations:

- A visitor comes to the office and needs to be granted restrictive Internet access, but is not in the corporate user directory.

- An employee from another branch location (or from an acquired company) comes to the corporate headquarters, and needs Internet access. The user directories of the branch location (or acquired company) and corporate headquarters are separate, so the employee's credentials do not work in the corporate headquarters.
- A new hire has been provided credentials in an email but they are not yet populated in the authentication server.
- A user logs into a Windows workstation using a local account instead of a Windows domain account and the user needs access to the Internet.

The authentication server administrator in your organization can create a guest user account in the user directory. However, allowing guest access through the Web Security appliance has the benefit that the administrator does not have to communicate the guest credentials to every visitor.

To grant guest access to users who fail authentication, you create an Identity that requires authentication, but also allows guest privileges. Then you create another policy using that Identity and apply that policy to the guest users. When users who fail authentication have guest access, they can access the resources defined in the policy group that specifies guest access for that Identity.

A user who fails authentication has all transactions *blocked* if *either* of the following conditions are true:

- Guest privileges are not provided in any Identity.
- The user does not match any Identity that provides guest privileges.

A user who fails authentication has transactions *allowed* when *all* of the following conditions are true:

- The user matches an Identity with guest privileges.
- A non-Identity policy group uses that Identity and applies to guest users.

For example, you can create an Access or Decryption Policy that is specific to guest users.

**Note**

If an Identity allows guest access and there is no user defined policy group that uses that Identity, users who fail authentication match the global policy for that policy type. For example, if MyIdentity allows guest access and there is no user defined Access Policy that uses MyIdentity, users who fail authentication match the global Access Policy. If you do not want guest users to match a global policy, create a policy group above the global policy that applies to guest users and blocks all access.

When the Web Proxy grants a user guest access, it identifies and logs the user as a guest in the access logs. You can specify whether the Web Proxy identifies the user by IP address or user name. In the access logs, reports, and end-user acknowledgement page, entries for guest users have one of the following formats:

- (unauthenticated)*IP\_address*
- (unauthenticated)*username\_entered*

You can enable guest access for an Identity that uses any authentication protocol or scheme.

- 
- Step 1** Define an Identity group and enable the Support Guest privileges option.
- Step 2** Create an Access, Decryption, Routing, Data Security, or External DLP Policy and select the Identity created in step 1.
- Step 3** In the Access, Decryption, Routing, Data Security, or External DLP Policy group membership, select “Guests (users failing authentication)” for the Identity in step 1.
- Step 4** Submit and commit your changes.

**Note**

You can configure the Web Proxy to request authentication again if an authenticated user is blocked from a website due to restrictive URL filtering. To do this, enable the “Enable Re-Authentication Prompt If End User Blocked by URL Category or User Session Restriction” global authentication setting. For more information, see [Allowing Users to Re-Authenticate, page 20-25](#).

## Identifying Users Transparently

Traditionally, users identified by an authentication user name are prompted to enter a user name and password. The credentials the user enters are then validated against an authentication server, and then the Web Proxy applies the appropriate policies to the transaction based on the authenticated user name.

However, you can configure the Web Security appliance so that it identifies users by an authenticated user name transparently—that is, without prompting the end user. Identification is a method of obtaining user credentials that have been obtained from another trusted source. AsyncOS for Web assumes that the username has already been authenticated by the trusted source providing the username.

You might want to identify users transparently to:

- Create a single sign-on environment so users are not aware of the presence of a proxy on the network.
- Use authentication based policies to apply to transactions coming from client applications that are incapable of displaying the authentication prompt to end users.

Identifying users transparently only affects how the Web Proxy obtains the user name and assigns an Identity group. After it obtains the user name and assigns an Identity, it applies all other policies normally, regardless of how it assigned the Identity.

To identify users transparently, complete the following basic steps:

1. Define at least one authentication realm that supports transparent user identification. For more information, see [Understanding Transparent User Identification, page 8-12](#).
2. Create an Identity group that identifies user transparently, and then specify the authentication realm created in the previous step.

**Note**

You can also transparently identify remote users when using Secure Mobility. For more information, see [Transparently Identifying Remote Users, page 14-3](#).

## Understanding Transparent User Identification

You can identify users transparently using one of the following authentication servers:

- **An Active Directory agent** . Create an NTLM authentication realm and enable transparent user identification. In addition, you must deploy a separate Active Directory agent utility. Cisco recommends Cisco Context Directory Agent. For more information, see [Transparent User Identification with Active Directory, page 8-13](#).
- **Novell eDirectory**. Create an LDAP authentication realm that supports Novell eDirectory. For more information, see [Transparent User Identification with Novell eDirectory, page 8-15](#).

AsyncOS for Web works with either Novell eDirectory or an Active Directory agent to maintain a mapping that matches authenticated user names to their current IP addresses. AsyncOS for Web communicates with the Novell eDirectory server and an Active Directory agent at regular intervals to maintain the current IP address to user name mapping.

The following steps are followed when transparent user identification is enabled:

1. Client makes a request for a website.
2. Web Security appliance receives the client request and obtains the IP address from the request.
3. AsyncOS for Web checks the IP address to user name mapping stored on the Web Security appliance to assign a user name to the client request. If no match is found for transparent user identification with Active Directory, AsyncOS for Web then contacts an Active Directory agent to find a matched user name.
4. Assuming it matches a user name to the IP address, AsyncOS for Web fetches the user groups from the Novell eDirectory server or Active Directory Server.
5. AsyncOS for Web applies policies to the transaction as appropriate.

If the IP address does not match a user name, you can configure how to handle the transaction. You can grant the end user guest access, or you can force an authentication prompt to appear to the end user.

When an end user is shown an authentication prompt due to failed transparent user identification, and the user then fails authentication due to invalid credentials, you can choose whether to allow the user guest access. [Figure 8-3](#) shows where you grant user access when configuring an Identity for transparent user identification.

**Figure 8-3 Granting Guest Access—Transparent User Identification**

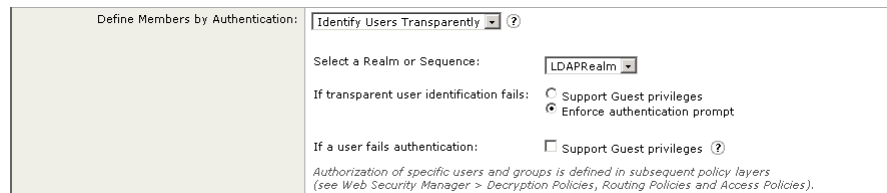

The current IP address to user name mapping is updated, by default, every 600 seconds. You can change this time interval using the `tuiconfig` CLI command. For more information, see [Using the CLI to Configure Transparent User Identification, page 8-17](#).



**Note**

When you enable re-authentication and a transaction is blocked by URL filtering, an end-user notification page appears with the option to log in as a different user. Users who click the link are prompted for authentication. For more information, see [Allowing Users to Re-Authenticate, page 20-25](#).

## Transparent User Identification with Active Directory

Active Directory does not record user login event information in a method that is easily queried by other servers, such as the Web Security appliance. However, Cisco offers the Cisco Context Directory Agent that queries the Active Directory security event logs to maintain an IP address to user name mapping of users authenticated with Active Directory. Active Directory agents, including Cisco Context Directory Agent and others, act as a type of identity repository.

AsyncOS for Web communicates with an Active Directory agent to maintain a local copy of the IP address to user name mapping. When AsyncOS for Web needs to associate an IP address with a user name, it first checks its local copy of the mapping. If no match is found, it queries an Active Directory agent to find a match.

For more information on installing and configuring an Active Directory agent, see [Setting Up the Active Directory Agent to Provide Information to the Web Security Appliance, page 8-14](#).

Consider the following rules and guidelines when you identify users transparently using Active Directory:

- Transparent user identification with Active Directory works with an NTLM authentication realm only. You cannot use it with an LDAP authentication realm that corresponds to an Active Directory instance.
- Transparent user identification works with the versions of Active Directory supported by an Active Directory agent.
- Optionally, you can install a second instance of an Active Directory agent on a different machine to achieve high availability. When you do this, each Active Directory agent maintains an IP address to user name mapping independently of the other agent. AsyncOS for Web uses the backup Active Directory agent after three unsuccessful ping attempts to the primary agent.
- The Active Directory agent uses on-demand mode when it communicates with the Web Security appliance.
- The Active Directory agent pushes user logout information to the Web Security appliance. However, some user logout information never gets recorded in the Active Directory server security logs. This might happen if the client machine crashes or if the user shuts down the machine without logging out. If there is no user logout information in the security logs, an Active Directory agent cannot inform the appliance that the IP address no longer is assigned to that user. Because of this, you can define the timeout value for how long AsyncOS caches the IP address to user mapping when there are no updates from an Active Directory agent. For more information, see [Using the CLI to Configure Transparent User Identification, page 8-17](#).
- The Active Directory agent records the sAMAccountName for each user logging in from a particular IP address to ensure the user name is unique.
- The client IP addresses that the client machines present to the Active Directory server and the Web Security appliance must be the same.
- AsyncOS for Web only searches for direct parent groups that the user belongs to. It does not search nested groups.

### Setting Up the Active Directory Agent to Provide Information to the Web Security Appliance

Because AsyncOS for Web cannot obtain client IP addresses directly from Active Directory, it must obtain IP address to user name mapping information from an Active Directory agent.

Install an Active Directory agent on a machine on the network that is accessible to the Web Security appliance and can communicate with all Windows domain controllers in the forest. For best performance, this machine should be as close as possible to the Web Security appliance on the network. In smaller network environments, you may want to install an Active Directory agent directly on the Active Directory server.

[Figure 8-4](#) shows where an Active Directory agent is installed in the network.

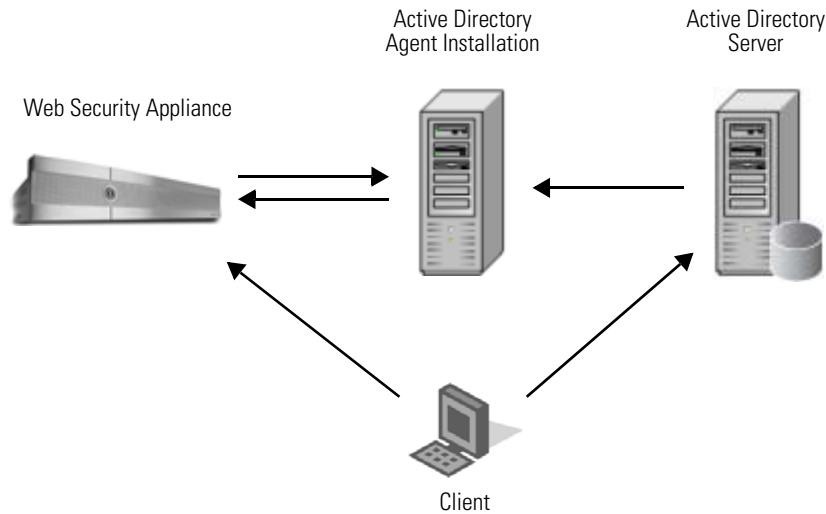

**Figure 8-4 Active Directory Agent Workflow****Note**

The Active Directory agent instance used for communicating with the Web Security appliance can also support other products, such as the adaptive security appliance and other Web Security appliances.

**Obtaining, Installing, and Configuring Cisco Context Directory Agent**

You can find information about downloading, installing, and configuring the Cisco Context Directory Agent here: [http://www.cisco.com/en/US/docs/security/ibf/cda\\_10/Install\\_Config\\_guide/cda10.html](http://www.cisco.com/en/US/docs/security/ibf/cda_10/Install_Config_guide/cda10.html).

**Note**

The Web Security appliance and Active Directory agents communicate with each other using the RADIUS protocol. The appliance and the agent must be configured with the same shared secret to obfuscate user passwords. Other user attributes are not obfuscated.

## Transparent User Identification with Novell eDirectory

AsyncOS for Web communicates with the Novell eDirectory Server to maintain an IP address to user name mapping. When a user logs into a client machine through the Novell Client, Novell Client authenticates the user against the Novell eDirectory Server. When authentication succeeds, the client machine IP address is recorded in the Novell eDirectory Server as an attribute (NetworkAddress field) of the user who logged into the workstation.

Consider the following rules and guidelines when you identify users transparently using Novell eDirectory:

- Novell Client must be installed on each client machine, and end users must use it to authenticate against a Novell eDirectory server.
- The Novell LDAP tree used by the Novell client login must be the same LDAP tree configured in the authentication realm.
- If the Novell clients use multiple Novell LDAP trees, create an authentication realm for each tree, and then create an authentication sequence that uses each Novell LDAP authentication realm.
- When you configure the LDAP authentication realm for Novell eDirectory, you must specify a Bind DN for the query credentials.

- Novell eDirectory must be configured to update the NetworkAddress attribute of the user object when users login. For more information on how to do this, see the following Novell support article: [http://www.novell.com/support/php/search.do?cmd=displayKC&docType=kc&externalId=7004564&sliceId=1&docTypeID=DT\\_TID\\_1\\_1&dialogID=100407203&stateId=0%200%20100405493?](http://www.novell.com/support/php/search.do?cmd=displayKC&docType=kc&externalId=7004564&sliceId=1&docTypeID=DT_TID_1_1&dialogID=100407203&stateId=0%200%20100405493?)



**Note** Novell eDirectory versions 8.6, 8.7, and 8.8 can be configured to update the NetworkAddress attribute.

- When querying Novell eDirectory, AsyncOS for Web only searches for direct parent groups that the user belongs to. It does not search nested groups.
- You can use the “network address” field of the user in Novell eDirectory to obtain the IP address of the workstation from where the user previously logged in.

## Rules and Guidelines

Consider the following rules and guidelines when using transparent user identification with any authentication server:

- When using DHCP to assign IP addresses to client machines, ensure the IP address to user name mapping is updated on the Web Security appliance more frequently than the DHCP lease. Use the `tuiconfig` CLI command to update the mapping update interval. For more information, see [Using the CLI to Configure Transparent User Identification, page 8-17](#).
- If an end user logs out of a machine and another user logs in to the same machine before the IP address to user name mapping is updated on the Web Security appliance, then the Web Proxy logs the client as the previous user.
- You can configure how the Web Proxy handles transactions when transparent user identification fails. It can grant users guest access, or it can force an authentication prompt to appear to end users.
- When a user is shown an authentication prompt due to failed transparent user identification, and the user then fails authentication due to invalid credentials, you can choose whether to allow the user guest access.
- When the assigned Identity uses an authentication sequence with multiple realms in which the user exists, AsyncOS for Web fetches the user groups from the realms in the order in which they appear in the sequence.
- When you configure an Identity to transparently identify users, the authentication surrogate must be IP address. You cannot select a different surrogate type.
- When you view detailed transactions for users, the Web Tracking page shows which users were identified transparently.
- When you configure an Identity to identify users transparently, AsyncOS for Web only displays sequences in which all realms have transparent user identification enabled.
- You can log which users were identified transparently in the access logs and WC3 logs using the `%m` and `x-auth-mechanism` custom fields. A value of `SSO_TUI` indicates that the user name was obtained by matching the client IP address to an authenticated user name using transparent user identification. (Similarly, a value of `SSO_ASA` indicates that the user is a remote user and the user name was obtained from a Cisco ASA using the Secure Mobility Solution.)

## Configuring Transparent User Identification

- 
- Step 1** Create an LDAP authentication realm for a Novell eDirectory server. Configure the realm to use Version 3 and to “Support Novell eDirectory.”
- Step 2** Define an Identity group that identifies users transparently using Novell eDirectory:
- In the **Identification and Authentication** section, select **Identify Users Transparently**.
  - Select the LDAP authentication realm that supports Novell eDirectory.
  - Configure all other Identity options as desired.
- Step 3** Create policies that use the Identity for transparent user identification.
- 

### Related topics

- [LDAP Authentication, page 20-28](#)
- [Adding an LDAP Authentication Realm, page 20-10](#)
- [Creating Identities, page 8-18](#)

## Using the CLI to Configure Transparent User Identification

AsyncOS for Web includes the following CLI commands to use with transparent user identification:

- tuiconfig.** This command allows you to configure some settings associated with transparent user identification. You can use this command in batch mode.
  - Configure mapping timeout for AD agent.** Enter the timeout value for how long AsyncOS caches the IP address to user mapping for an IP address as retrieved from the Active Directory agent when there are no updates from the agent.
  - Configure mapping timeout for Novell eDirectory.** Enter the timeout value for how long AsyncOS caches the IP address to user mapping for an IP address as retrieved from the Novell eDirectory server when there are no updates from the server.
  - Configure query wait time for AD agent.** Enter the time to wait for a reply from the Active Directory agent in seconds. When the query takes more than the timeout value, transparent user identification is considered to have failed. This limits the authentication delay experienced by the end user.
  - Configure query wait time for Novell eDirectory.** Enter the time to wait for a reply from the Novell eDirectory server in seconds. When the query takes more than the timeout value, transparent user identification is considered to have failed. This limits the authentication delay experienced by the end user.
- tuistatus.** This command includes the following subcommands:
  - adagentstatus.** This command displays the current status of all Active Directory agents as well as information about their connections with the Windows domain controllers.
  - listlocalmappings.** This command lists all entries in the IP address to user name mapping stored on the Web Security appliance as retrieved from the Active Directory agent. It does not list entries stored in the Active Directory agent.

# Creating Identities

You can create Identities based on combinations of several criteria, such as client subnet or the URL category of the destination site. You must define at least one criterion for Identity membership. When you define multiple criteria, the client request must meet all criteria to match the Identity.

For more information about how the Web Proxy matches a client request with an Identity, see [Evaluating Identity Group Membership, page 8-4](#) and [Matching Client Requests to Identity Groups, page 8-8](#).

You define Identity group membership on the Web Security Manager > Identities page.



---

**Note** Deleting an authentication realm or sequence disables Identities that depend on the deleted realm or sequence.

---

**Step 1** Navigate to the Web Security Manager > Identities page.

**Step 2** Click **Add Identity**.

**Step 3** Enter a name for the Identity group and an optional description.



---

**Note** Each Identity group name must be unique and only contain alphanumeric characters or the space character.

---

**Step 4** In the Insert Above field, choose where in the policies table to place the Identity group.

When configuring multiple Identity groups, specify a logical order for each group. Carefully order your Identity groups to ensure that correct matching occurs. Position groups that do not require authentication above the first policy group that requires authentication. For more information about how authentication affects Identity groups, see [Understanding How Authentication Affects Identity Groups, page 8-5](#).

**Step 5** In the Define Members by User Location section, configure the Identity to apply to local users, remote users, or both local and remote users.

The setting chosen here affects the available authentication settings for this Identity.



---

**Note** This section only appears when the Secure Mobility is enabled. For more information, see [Achieving Secure Mobility Overview, page 14-1](#).

---

**Step 6** In the Define Members by Subnet field, enter the addresses to which this Identity should apply.

You can enter IP addresses, CIDR blocks, and subnets. Separate multiple addresses with commas.



---

**Note** If you do not enter an address in this field, the Identity group applies to *all* IP addresses. For example, if you configure the Identity to require authentication, but do not define any other settings, then the Identity acts similarly to the Default Identity Policy with authentication required.

---

**Step 7** In the Define Members by Protocol section, choose to which protocols this Identity should apply.



---

**Note** **HTTP/HTTPS Only** applies to all requests that use HTTP or HTTPS as the underlying protocol, including FTP over HTTP and any other protocol tunneled using HTTP CONNECT.

---

**Step 8** In the **Identification and Authentication** section, select one of these options:

- **No Identification or Authentication.** The user is identified primarily by IP address. Go to [Step 15](#).
- **Identify Users Transparently.** The user is identified by the current IP address to user name mapping. This option is available when at least one authentication realm is defined that supports transparent user identification. Go to [Step 10](#).
- **Identify Users Transparently through Cisco ASA Integration.** The user is identified by the current IP address to user name mapping received from the Cisco adaptive security appliance (ASA). This option appears when Secure Mobility is enabled and integrates with a Cisco adaptive security appliance, and when Remote Users is selected in [Step 5](#). Go to [Step 11](#).



---

**Note** (For deployments with a Security Management appliance) When configuring Identities on a Security Management appliance, this option appears when a Web Security appliance with an authentication realm that supports transparent user identification has been added as a managed appliance.

---

- **Authenticate Users** The user is identified by the authentication credentials entered. This option appears when at least one authentication realm is defined. Go to [Step 9](#).

**Step 9** Configure the Identity to authenticate users:

- a. In the Select a Realm or Sequence field, choose a defined authentication realm or sequence.
- b. If you choose an NTLM authentication realm or sequence that contains an NTLM authentication realm, then choose an authentication scheme in the Select a Scheme field.
- c. To grant guest access to users who fail authentication due to invalid credentials, select the Support Guest privileges check box.

For more information, see [Allowing Guest Access to Users Who Fail Authentication, page 8-10](#).



---

**Note** You can specify individual authenticated users or groups of users when you use the Identity in a different type of policy group. For more information, see [Configuring Identities in Other Policy Groups, page 8-22](#).

---

- d. Go to [Step 12](#).

**Step 10** To configure the Identity to use transparent user identification:

- a. In the Select a Realm or Sequence field, choose a defined authentication realm that supports transparent user identification, either an LDAP authentication realm that supports Novell eDirectory or an NTLM authentication realm that is enabled for transparent user identification. You can also choose a sequence that contains only realms that support transparent user identification.
- b. Choose how to handle transactions when transparent user identification fails: either grant users guest access, or force an authentication prompt to appear to end users.

Transparent user identification might fail if the Web Proxy cannot determine the user who is currently logged in from the specified IP address. That is, if the IP address is not in the IP address to user mapping.

- c. Choose whether to allow the user guest access when a user is shown an authentication prompt due to failed transparent user identification and the user then fails authentication due to invalid credentials.

For more information on transparent user identification, see [Identifying Users Transparently, page 8-12](#).

d. Go to [Step 12](#).

**Step 11** To configure the Identity to use transparent user identification by integrating with a Cisco adaptive security appliance (ASA):

- a. In the Select a Realm or Sequence field, choose a defined authentication realm or sequence.
- b. If you choose an NTLM authentication realm or sequence that contains an NTLM authentication realm, then choose the authentication scheme in the Select a Scheme field.



**Note** You can specify individual authenticated users or groups of users when you use the Identity in a different type of policy group. For more information, see [Configuring Identities in Other Policy Groups, page 8-22](#).

c. Go to [Step 12](#).

**Step 12** View the settings in the **Authentication Surrogate** section.

**Step 13** Choose how transactions used for authenticating the client are associated with a user (either by IP address or by using a cookie) after the user has authenticated successfully. Choose one of the options in [Table 8-2](#):

**Table 8-2** *Surrogate Types*

Surrogate Type	Description
IP Address	The Web Proxy tracks an authenticated user at a particular IP address. To achieve transparent user identification, you must choose IP-based authentication.
Persistent Cookie	The Web Proxy tracks an authenticated user on a particular application by generating a persistent cookie for each user per application. Closing the application does not remove the cookie.
Session Cookie	The Web Proxy tracks an authenticated user on a particular application by generating a session cookie for each user per domain per application. (However, when a user provides different credentials for the same domain from the same application, the cookie is overwritten.) Closing the application removes the cookie.
No Surrogate	The Web Proxy does not use a surrogate to cache the credentials, and it tracks an authenticated user for every new TCP connection. When you choose this option, the web interface disables other settings that no longer apply.  This option is available only in explicit forward mode and when you disable credential encryption on the Network > Authentication page.

You might want to use IP-based authentication when:

- There is only one user on a client machine and you want users to be able to achieve single sign-on behavior.
- You want to use transparent user identification.
- You want to create an Identity that works with applications that do not work with cookie-based surrogates, such as MSN Messenger.

You might want to choose cookie-based authentication when there are multiple users on one machine, such as a Citrix server or a kiosk shared by many users.

For more information about which authentication surrogates are supported with other configurations and different types of requests, see [Tracking Authenticated Users, page 20-27](#).



**Note** You can define a timeout value for the authentication surrogate for all requests. For more information, see [Configuring Global Authentication Settings, page 20-18](#).

**Step 14** In the Explicit Forward Request field, choose whether or not the surrogate used for transparent requests should also be used for explicit requests.

Enabling credential encryption automatically enables this field.

This option appears only when the Web Proxy is deployed in transparent mode.

**Step 15** Optionally, expand the Advanced section to define additional membership requirements.

**Table 8-3 Identity Group Advanced Options**

Advanced Option	Description
Proxy Ports	<p>To define policy group membership by the proxy port used to access the Web Proxy, enter one or more port numbers in the Proxy Ports field. Separate multiple ports with commas.</p> <p>For explicit forward connections, this is the port configured in the browser. For transparent connections, this is the same as the destination port. You might want to define policy group membership on the proxy port if you have one set of clients configured to explicitly forward requests on one port, and another set of clients configured to explicitly forward requests on a different port.</p> <p><b>Note:</b> Cisco recommends defining policy group membership by the proxy port only when the appliance is deployed in explicit forward mode, or when clients explicitly forward requests to the appliance. If you define policy group membership by the proxy port when client requests are transparently redirected to the appliance, some requests might be denied.</p>
URL Categories	<p>Choose the user defined or predefined URL categories.</p> <p>Membership for both user defined and predefined URL categories is excluded by default, meaning the Web Proxy ignores all categories unless they are selected in the Add column.</p>
User Agents	<p>Choose whether or not to define policy group membership by the user agent used in the client request. You can select some commonly defined browsers, or define your own using regular expressions. Choose whether this policy group should apply to the selected user agents or to any user agent that is not in the list of selected user agents.</p> <p>For more information on creating user agent based policies, see <a href="#">Working with User Agent Based Policies, page 7-10</a>.</p>

**Step 16** Submit and commit your changes.



**Note** When you commit a change to Identities, end-users must re-authenticate.

## Configuring Identities in Other Policy Groups

Every non-Identity policy group specifies at least one Identity group as part of its policy group membership. You can configure a non-Identity policy group to use multiple Identity groups, and you can specify which users or groups of users are authorized to access the web using the policy group.

You might want to specify multiple Identity groups in a policy group under the following circumstances:

- You have an Identity group defined for HTTP transactions and another Identity group defined for native FTP transactions. You can create a single non-Identity policy group that applies to both HTTP and native FTP transactions
- Separate Identity groups are defined for each authentication realm. You want to create one Access Policy group that defines the same access control settings for users in multiple authentication realms.



### Note

You can also specify All Identities and configure the authenticated users.

Figure 8-5 shows a policy group that uses multiple Identities.

**Figure 8-5 Multiple Identities in a Policy Group**

Identity	Authorized Users and Groups	
IdentityPolicy2	<input checked="" type="radio"/> All Authenticated Users Realm: NTLMRealm2 <input type="radio"/> Selected Groups and Users Groups: No groups entered Users: No users entered	
IdentityPolicy1	<input type="radio"/> All Authenticated Users <input checked="" type="radio"/> Selected Groups and Users Groups: <b>Realm: NTLMRealm1</b> WGA\Administrator1 WGA\Cert Publishers WGA\Domain Guests Users: No users entered <input type="radio"/> Guests (users failing authentication)	
IdentityPolicyForFTP	No authentication required	
IdentityPolicy4	<input type="radio"/> All Authenticated Users <input type="radio"/> Selected Groups and Users Groups: No groups entered Users: No users entered <input checked="" type="radio"/> Guests (users failing authentication)	

This Identity allows guest access and applies to users who fail authentication.

Authentication is not used for this Identity.

The specified user groups in this Identity are authorized for this policy group.

This Identity uses an authentication sequence and this policy group applies to one realm in the sequence.



### Note

If an Identity group becomes disabled, then that Identity group is *removed* (not disabled) from any non-Identity policy group that used it. If the Identity group becomes enabled again, the non-Identity policy groups that previously used the Identity do not automatically include the enabled Identity. Identity groups become disabled due to a deleted authentication realm or sequence.



- 
- Step 1** Create a new policy group or edit the membership of an existing policy group for Access, Decryption, Routing, Data Security, or External DLP Policy.
- Step 2** Scroll down to the Identities and Users section.
- Step 3** Choose one of the following options from the dropdown menu:
- **Select One or More Identities.** This option allows you to configure specific Identity groups. Go to step 4.
  - **All Identities.** This option specifies all configured Identity groups. Go to step 5.
- Step 4** Under the Identity column, choose the Identity group to apply to this policy group.
- Step 5** If you choose an Identity that requires authentication, you can specify which users are authorized for this policy group. These users must authenticate. In the Authorized Users and Groups column, choose one of the following options:
- **All authenticated users.** You can configure the Identity in this policy group to apply to all *authenticated* users in the Identity group by default. If the Identity group specifies an authentication sequence, you can configure this policy group to apply to one authentication realm or all realms in the sequence.
  - **Selected Groups and Users.** You can configure the Identity in this policy group to apply to specific users. You can define users by group object or user object. Click the link for either Groups or Users, and enter the group or user information on the page that opens.  
When you add groups of users for an Identity using an NTLM authentication realm, the Edit Groups page displays the first 500 matching entries, omitting built-in groups.
  - **Guests (users failing authentication).** If the Identity group allows guest access, you can configure this policy group to apply to all users who fail to authenticate in this Identity. For more information, see [Allowing Guest Access to Users Who Fail Authentication, page 8-10](#).
  - **All users (authenticated and unauthenticated users).** You can configure this policy group to apply to every user in every Identity group. This option only appears when you choose All Identities.  
When you apply the policy group to all users, you must specify at least one advanced option to distinguish this policy group from the global policy.
- Step 6** (Optional) Add another Identity group to this policy group by clicking **Add Identity**.  
You can add additional Identity groups if you configured specific Identity groups instead of All Identities.
- Step 7** If you add another Identity group, repeat steps 4 through 5.
- Step 8** Submit and commit your changes.
- 

## Example Identity Policies Tables

This section shows some sample Identity groups defined in an Identity policies table and describes how the Web Proxy evaluates different client requests using each Identity policies table.

## Example 1

Table 8-4 shows an Identity policies table with three user defined Identity groups. The first Identity group applies to a particular subnet and does not require authentication. The second Identity group applies to all subnets and requests for URLs in the “Proxies & Translators” category, and requires authentication on RealmA. The third Identity group applies to all subnets, has no advanced options defined, and requires authentication on RealmA. The global Identity policy applies to all subnets (by definition) and does not require authentication.

**Table 8-4 Policies Table Example 1**

Order	Subnet(s)	Authentication Required?	Realm or Sequence	Advanced Options
1	10.1.1.1	No	N/A	none
2	All	Yes	RealmA	URL Category is “Proxies & Translators”
3	All	Yes	RealmA	none
Global Identity policy	All (by default)	No	N/A	N/A (none by default)

The Web Proxy matches client requests to Identity groups in this scenario differently, depending on the client’s subnet and the URL category of the request:

- **Any client on subnet 10.1.1.1 for any URL.** When a client on subnet 10.1.1.1 sends a request for any URL, the Web Proxy evaluates the first Identity group and determines that the client subnet matches the first Identity group subnet. Then it determines that no authentication is required and no advanced options are configured, so it assigns the first Identity group to the transaction.
- **Any client on a subnet other than 10.1.1.1 for URLs in the “Proxies & Translators” URL category.** When a client on a subnet other than 10.1.1.1 sends a request for a URL in the “Proxies & Translators” category, the Web Proxy evaluates the first Identity group and determines that the client subnet is not listed in the first Identity group’s list of subnets. Therefore, it evaluates the second Identity group, and then determines that the client subnet is listed in the second Identity group’s list of subnets. Then it determines that the URL in the request matches the URL category in the second Identity group’s advanced section. Then it determines that the second Identity group requires authentication, so it tries to authenticate the user against the authentication server(s) defined in RealmA. If the user exists in RealmA, the Web Proxy assigns the second Identity group to the transaction. If the user does not exist in RealmA, AsyncOS terminates the client request because the client failed authentication.
- **Any client on a subnet other than 10.1.1.1 for any URL *not* in the “Proxies & Translators” URL category.** When a client on a subnet other than 10.1.1.1 sends a request for a URL, the Web Proxy evaluates the first Identity group and determines that the client subnet is not listed in the first Identity group’s list of subnets. Therefore, it evaluates the second Identity group, and then determines that the client subnet is listed in the second Identity group’s list of subnets. Then it determines that the URL in the request *does not* match the URL category in the second Identity group’s advanced section. Therefore, it evaluates the third Identity group, and then determines that the client subnet is listed in the third Identity group’s list of subnets. The third Identity group does not have any advanced options configured, so continues to compare against authentication requirements. Then it determines that the third Identity group requires authentication, so it tries to authenticate the user

against the authentication server(s) defined in RealmA. If the user exists in RealmA, the Web Proxy assigns the third Identity group to the transaction. If the user does not exist in RealmA, the Web Proxy terminates the client request because the client failed authentication.

Note that in this scenario, most client requests will never match the global Identity group because of the user defined Identity group (the third group) that applies to all subnets, has no advanced options, and requires authentication. Any client on the network that does not match the first or second Identity group will match the third Identity group. The exception to this is for HTTPS requests when the appliance is in transparent mode with cookie-based authentication. Any client on a subnet other than 10.1.1.1 will match the global Identity group even though it requires authentication.

## Example 2

Table 8-5 shows a policies table with two user defined Identity groups. The first Identity group applies to all subnets, requires authentication, and specifies RealmA for authentication. The second Identity group applies to all subnets, requires authentication, and specifies RealmB for authentication. Neither Identity group has any advanced option configured. The global Identity group applies to all subnets, requires authentication, and specifies the All Realms sequence for authentication.

**Table 8-5 Policies Table Example 2**

Order	Subnet(s)	Authentication Required?	Realm or Sequence	Advanced Options
1	All	Yes	RealmA	none
2	All	Yes	RealmB	none
Global Identity policy	All	Yes	All Realms	N/A (none by default)

In this scenario, when a client sends a request for a URL, the Web Proxy evaluates the first Identity group and determines that the Identity group applies to all subnets and has no advanced options configured. It determines that the Identity group requires authentication and that the only realm specified in the Identity group is RealmA. Therefore, *in order for a client on any subnet to pass authentication, it must exist in RealmA.*

When a client that exists in RealmA sends a request for a URL, the client passes authentication and the Web Proxy assigns the first Identity group to the transaction. When a client that does *not* exist in RealmA sends a request for a URL, the client fails authentication and the Web Proxy terminates the request.

Note that when a client in RealmB sends a request for a URL, the Web Proxy does *not* match the client request with the second Identity group. This is because a previous Identity group already applies to the same subnets (and the exact same advanced options, which in this example is none) in the second Identity group and it requires authentication, but from RealmA instead. Clients in RealmB do not “fall through” to the second Identity group.

If you want users in RealmB to have different Access, Decryption, and Routing Policy settings applied to them than users in RealmA, perform the following steps:

- Step 1** Create an authentication sequence that contains both RealmA and RealmB. You can choose the order of the realms in the sequence depending on your business needs.
- Step 2** Create one Identity group and configure it for whichever subnets on which users in RealmA and RealmB might exist. In this example, you would configure the Identity group for all subnets.
- Step 3** Configure the Identity group to use the sequence you defined in step 1.

- Step 4** Create two user defined policy groups of the same type, such as Access Policies, and configure them both to use the Identity group with the authentication sequence you defined in step 3.
- Step 5** Configure the first policy group to only apply to users in one realm, such as RealmA. You can do this by specifying a particular realm in the sequence, or by using authentication groups, or entering specific usernames.
- Step 6** Configure the second policy group to only apply to users in the other realm, such as RealmB. You can do this by specifying a particular realm in the sequence, or by using authentication groups, or entering specific usernames.

When you configure the appliance in this way, any client that sends a request for a URL must exist in either realm in the sequence (RealmA or RealmB) in order to pass authentication at the Identity level. Once an Identity has been assigned to the client request, the Web Proxy can compare the client request against the other policy types and determine which policy group, such as an Access Policy group, to match and then apply those control settings. In this example, the Web Proxy matches users in RealmA with the policy group configured in step 5, and matches users in RealmB with the policy group configured in step 6.

# 9

## Block, Allow or Redirect Transaction Requests

- [Overview of Block, Allow, or Redirect Transaction Requests, page 9-1](#)
- [Evaluating Access Policy Group Membership, page 9-4](#)
- [Creating Access Policies, page 9-5](#)
- [Controlling HTTP and Native FTP Traffic, page 9-8](#)
- [Blocking Specific Applications and Protocols, page 9-12](#)

### Overview of Block, Allow, or Redirect Transaction Requests

The web proxy controls web traffic based on the policies that you create for groups of transaction requests.

- **Allow.** The Web Proxy permits the connection without interruption. Allowed connections may not have been scanned by the DVS engine.
- **Block.** The Web Proxy does not permit the connection and instead displays an end user notification page explaining the reason for the block.
- **Redirect.** The Web Proxy does not allow the connection to the originally requested destination server and instead connects to a different specified URL. You might want to redirect traffic at the appliance if your organization published the links to an internal site, but the location of the site changed since publication, or if you do not have control over the web server.

Generally, different types of policies control traffic based on the transport protocol.

Protocol	Policy Type				Notes
	Access	Decryption	FTP	SOCKS	
HTTP	X				
HTTPS	X	X			Decryption policy takes precedence over Access policy.
FTP	X		X		FTP Policy takes precedence over Access policy.
SOCKS				X	

You can configure AsyncOS to block, allow, or redirect transaction requests based on these characteristics of the transaction request:

- **Identity** assigned by AsyncOS to the transaction request
- **Protocol** the transaction will follow
- **Proxy Port** that received the request
- **Subnet** from which the request originated

- **Time Range** within which the request is made
- **URL Category** of the Destination web site
- **User Agents** (application) making the request

AsyncOS for Web uses multiple web security features in conjunction with its Web Proxy and DVS engine to control web traffic, protect networks from web-based threats, and enforce organization acceptable use policies. You can define policies that determine which HTTP connections are allowed and blocked.

To configure the appliance to handle HTTP requests, perform the following tasks:

- 
- Step 1 Enable the Web Proxy.** To allow or block HTTP traffic, you must first enable the Web Proxy. Usually, the Web Proxy is enabled during the initial setup using the System Setup Wizard. For more information, see [Configuring the Web Proxy, page 5-3](#).
- Step 2 Create and configure Access Policy groups.** After the Web Proxy is enabled, you create and configure Access Policy groups to determine how to handle each request from each user. For more information, see [Access Policy Groups, page 9-2](#).
- 

## Access Policy Groups

Access Policies define how the Web Proxy handles HTTP and FTP requests and decrypted HTTPS connections for network users. You can apply different actions to specified groups of users. You can also specify which ports the Web Proxy monitors for HTTP transactions.



### Note

HTTP PUT and POST requests are handled by Outbound Malware Scanning, Cisco IronPort Data Security, and External DLP Policies. For more information, see [Data Security and External DLP Policies Overview, page 13-1](#) and [Outbound Malware Scanning, page 12-1](#).

When the Web Proxy receives an HTTP request on a monitored port or a decrypted HTTPS connection, it compares the request to the Access Policy groups to determine which Access Policy group to apply. After it assigns the request to an Access Policy group, it can determine what to do with the request. For more information about evaluating policy group membership, see [Policy Group Membership, page 7-7](#).

The Web Proxy can perform any of the following actions on an HTTP request or decrypted HTTPS connection:

- **Allow.** The Web Proxy permits the connection without interruption. Allowed connections may not have been scanned by the DVS engine.
- **Block.** The Web Proxy does not permit the connection and instead displays an end user notification page explaining the reason for the block.
- **Redirect.** The Web Proxy does not allow the connection to the originally requested destination server and instead connects to a different specified URL. You might want to redirect traffic at the appliance if your organization published the links to an internal site, but the location of the site changed since publication, or if you do not have control over the web server. For more information about redirecting traffic, see [Redirecting Traffic, page 17-19](#).

**Note**

The preceding actions are final actions that the Web Proxy takes on a client request. The Monitor action that you can configure for Access Policies is not a final action. For more information, see [Understanding the Monitor Action, page 9-3](#).

After the Web Proxy assigns an Access Policy to an HTTP or decrypted HTTPS request, it compares the request to the policy group's configured control settings to determine which action to apply. You can configure multiple security components to determine how to handle HTTP and decrypted HTTPS requests for a particular policy group. For more information about the security components that you can configure and how the Web Proxy uses Access Policy groups to control HTTP traffic, see [Controlling HTTP and Native FTP Traffic, page 9-8](#).

## Understanding the Monitor Action

When the Web Proxy compares a transaction to the control settings, it evaluates the settings in order. Each control setting can be configured to perform one of the following actions for Access Policies:

- Monitor
- Allow
- Block
- Redirect

All actions except Monitor are final actions that the Web Proxy applies to a transaction. A final action is an action that causes the Web Proxy to stop comparing the transaction to the rest of the control settings.

The Monitor action is an intermediary action. The Web Proxy continues comparing the transaction to the other control settings to determine which final action to apply.

For example, if an Access Policy is configured to *monitor* a suspect user agent, the Web Proxy does not make a final determination about a request from the user agent. If an Access Policy is configured to *block* a particular URL category, then any request to that URL category is blocked before fetching the content from the server regardless of the server's reputation score.

**Note**

When a control setting matches Monitor and the transaction is ultimately allowed, the Web Proxy logs the monitored setting in the access logs. For example, when a URL matches a monitored URL category, the Web Proxy logs the URL category in the access logs.

[Figure 9-3 on page 9-9](#) shows the order that the Web Proxy uses when evaluating control settings for Access Policies. The flow diagram shows that the only actions applied to a transaction are the final actions: Allow, Block, and Redirect.

**Note**

[Figure 11-5 on page 11-21](#) shows the order the Web Proxy uses when evaluating control settings for Decryption Policies and [Figure 13-3 on page 13-11](#) shows the order when evaluating control settings for Cisco IronPort Data Security Policies.

# Evaluating Access Policy Group Membership

After the Web Proxy assigns an Identity to a client request, the Web Proxy evaluates the request against the other policy types to determine which policy group it belongs for each type. When the HTTPS Proxy is enabled, it applies HTTP and *decrypted* HTTPS requests against the Access Policies. When HTTPS Proxy is not enabled, by default, it evaluates HTTP and all HTTPS requests against the Access Policies.

The Web Proxy applies the configured policy control settings to a client request based on the client request's policy group membership.

To determine the policy group that a client request matches, the Web Proxy follows a specific process for matching the group membership criteria. During this process, it considers the following factors for group membership:

- **Identity.** Each client request either matches an Identity, fails authentication and is granted guest access, or fails authentication and gets terminated. For more information about evaluating Identity group membership, see [Evaluating Identity Group Membership, page 8-4](#).
- **Authorized users.** If the assigned Identity requires authentication, the user must be in the list of authorized users in the Access Policy group to match the policy group. The list of authorized users can be any of the specified groups or users or can be guest users if the Identity allows guest access.
- **Advanced options.** You can configure several advanced options for Access Policy group membership. Some options (such as proxy port and URL category) can also be defined within the Identity. When an advanced option is configured in the Identity, it is not configurable in the Access Policy group level.

The information in this section gives an overview of how the Web Proxy matches client requests to Access Policy groups. For more details about exactly how the Web Proxy matches client requests, see [Matching Client Requests to Access Policy Groups, page 9-4](#).

The Web Proxy sequentially reads through each policy group in the policies table. It compares the client request status to the membership criteria of the first policy group. If they match, the Web Proxy applies the policy settings of that policy group.

If they do not match, the Web Proxy compares the client request to the next policy group. It continues this process until it matches the client request to a user defined policy group. If it does not match a user defined policy group, it matches the global policy group. When the Web Proxy matches the client request to a policy group or the global policy group, it applies the policy settings of that policy group.

## Matching Client Requests to Access Policy Groups

[Figure 9-1 on page 9-5](#) shows how the Web Proxy evaluates a client request against the Access Policy groups.



Figure 9-1 Policy Group Flow Diagram for Access Policies

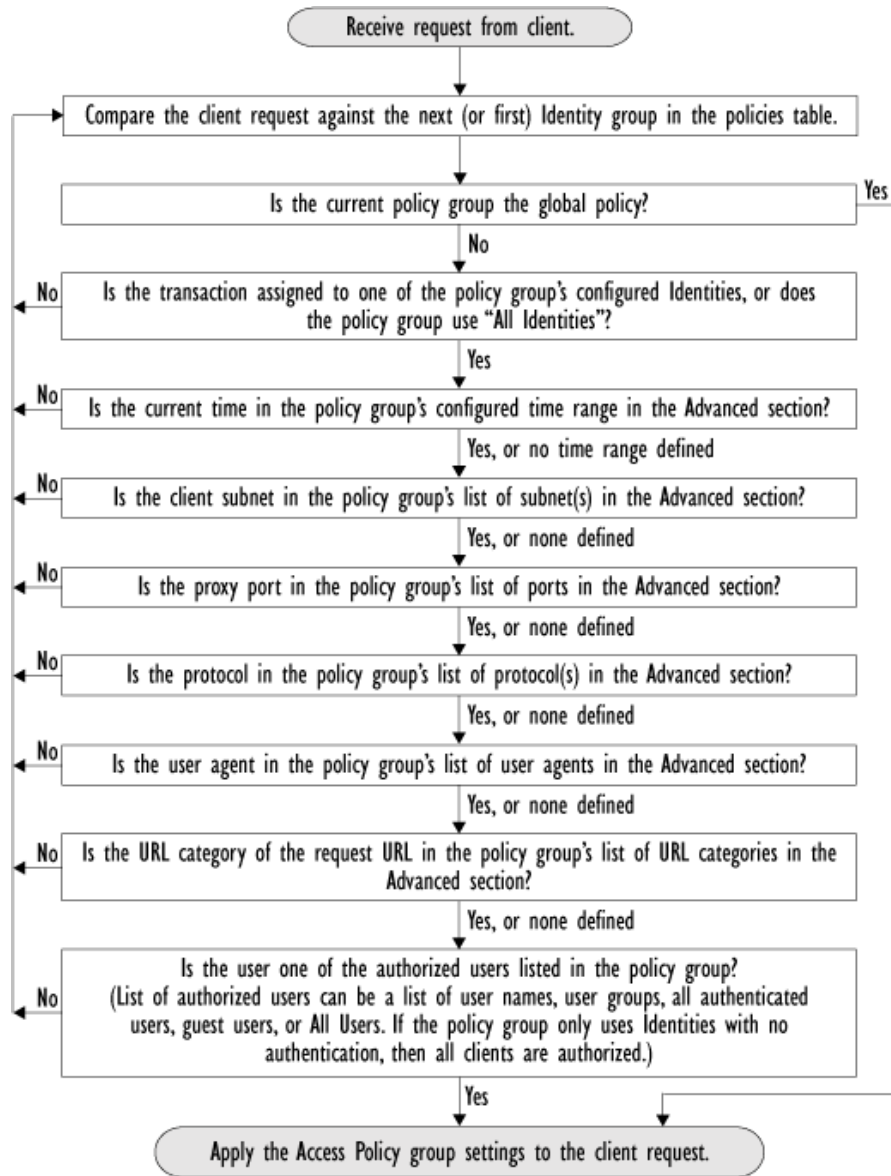

## Creating Access Policies

You can create Access Policy groups based on combinations of several criteria, such as one or more Identities or the URL category of the destination site. You must define at least one criterion for policy group membership. When you define multiple criteria, the client request must meet all criteria to match the policy group. However, the client request needs to match only one of the configured Identities.

For more information about how the Web Proxy matches a client request with a policy group, see [Evaluating Access Policy Group Membership, page 9-4](#) and [Matching Client Requests to Access Policy Groups, page 9-4](#).

You define policy group membership on the Web Security Manager > Access Policies page.

- Step 1** Navigate to the Web Security Manager > Access Policies page.
- Step 2** Click **Add Policy**.
- Step 3** In the Policy Name field, enter a name for the policy group, and in the Description field, optionally add a description.



**Note** Each policy group name must be unique and only contain alphanumeric characters or the space character.

- Step 4** In the Insert Above Policy field, choose where in the policies table to place the policy group. When configuring multiple policy groups you must specify a logical order for each group. Carefully order your policy groups to ensure that correct matching occurs.
- Step 5** In the Identities and Users section, choose one or more Identity groups to apply to this policy group. For more information on how to do this, see [Configuring Identities in Other Policy Groups, page 8-22](#).
- Step 6** Optionally, expand the Advanced section to define additional membership requirements.

**Table 9-1 Access Policy Group Advanced Options**

Advanced Option	Description
Protocols	<p>Choose whether or not to define policy group membership by the protocol used in the client request. Select the protocols to include.</p> <p>“All others” means any protocol not listed above this option.</p> <p><b>Note:</b> When the HTTPS Proxy is enabled, only Decryption Policies apply to HTTPS transactions. You cannot define policy membership by the HTTPS protocol for Access, Routing, Outbound Malware Scanning, Data Security, or External DLP Policies.</p>
Proxy Ports	<p>Choose whether or not to define policy group membership by the proxy port used to access the Web Proxy. Enter one or more port numbers in the Proxy Ports field. Separate multiple ports with commas.</p> <p>For explicit forward connections, this is the port configured in the browser. For transparent connections, this is the same as the destination port. You might want to define policy group membership on the proxy port if you have one set of clients configured to explicitly forward requests on one port, and another set of clients configured to explicitly forward requests on a different port.</p> <p>Cisco recommends only defining policy group membership by the proxy port when the appliance is deployed in explicit forward mode, or when clients explicitly forward requests to the appliance. If you define policy group membership by the proxy port when client requests are transparently redirected to the appliance, some requests might be denied.</p> <p><b>Note:</b> If the Identity associated with this policy group defines Identity membership by this advanced setting, the setting is not configurable at the non-Identity policy group level.</p>

**Table 9-1** Access Policy Group Advanced Options (continued)

Advanced Option	Description
Subnets	<p>Choose whether or not to define policy group membership by subnet or other addresses.</p> <p>You can choose to use the addresses that may be defined with the associated Identity, or you can enter specific addresses here.</p> <p><b>Note:</b> If the Identity associated with this policy group defines its membership by addresses, then in this policy group you must enter addresses that are a subset of the Identity's addresses. Adding addresses in the policy group further narrows down the list of transactions that match this policy group.</p>
Time Range	<p>Choose whether or not to define policy group membership by a defined time range. Choose the time range from the Time Range field and then choose whether this policy group should apply to the times inside or outside the selected time range.</p> <p>For more information on creating time based policies, see <a href="#">Working with Time Based Policies, page 7-9</a>.</p> <p>For more information on creating time ranges, see <a href="#">Creating Time Ranges, page 7-9</a>.</p>
URL Categories	<p>Choose whether or not to define policy group membership by URL categories. Select the user defined or predefined URL categories.</p> <p><b>Note:</b> If the Identity associated with this policy group defines Identity membership by this advanced setting, the setting is not configurable at the non-Identity policy group level.</p>
User Agents	<p>Choose whether or not to define policy group membership by the user agent used in the client request. You can select some commonly defined browsers, or define your own using regular expressions. Choose whether this policy group should apply to the selected user agents or to any user agent that is not in the list of selected user agents.</p> <p>For more information on creating user agent based policies, see <a href="#">Working with User Agent Based Policies, page 7-10</a>.</p> <p><b>Note:</b> If the Identity associated with this policy group defines Identity membership by this advanced setting, the setting is not configurable at the non-Identity policy group level.</p>
User Location	<p>Choose whether or not to define policy group membership by user location, either remote or local.</p> <p>This option only appears when the Secure Mobility is enabled. For more information, see <a href="#">Achieving Secure Mobility Overview, page 14-1</a>.</p>

**Step 7** Submit your changes.

**Step 8** Configure Access Policy group control settings to define how the Web Proxy handles transactions. The new Access Policy group automatically inherits global policy group settings until you configure options for each control setting. For more information, [Controlling HTTP and Native FTP Traffic, page 9-8](#).

**Step 9** Submit and commit your changes.

# Controlling HTTP and Native FTP Traffic

After the Web Proxy assigns an HTTP, native FTP, or decrypted HTTPS request to an Access Policy group, the request inherits the control settings of that policy group. The control settings of the Access Policy group determine whether the appliance allows, blocks, or redirects the connection.

Configure control settings for Access Policy groups on the Web Security Manager > Access Policies page.

Figure 9-2 shows where you can configure control settings for the Access Policy groups.

**Figure 9-2** Creating Secure Access Policies

## Access Policies

Policies							
Add Policy...							
Order	Group	Protocols and User Agents	URL Filtering	Applications	Objects	Web Reputation and Anti-Malware Filtering	Delete
1	ExampleAP1 Identity: TestLab	(global policy)	Block: 4 Warn: 3 Monitor: 59	Block: 6 Monitor: 13	(global policy)	(global policy)	
2	ExampleAP2 Identity: NTLMUsers	(global policy)	(global policy)	(global policy)	(global policy)	(global policy)	
	<b>Global Policy</b> Identity: All	No blocked items	Monitor: 66	Monitor: 19	No blocked items	Web Reputation: Enabled Webroot: Enabled McAfee: Disabled Sophos: Enabled	

Policy Disabled

You can configure the following settings to determine what action to take on the request:

- **Protocols and User Agents.** For more information, see [Protocols and User Agents, page 9-9](#).
- **URL Categories.** For more information, see [URL Categories, page 9-10](#).
- **Applications.** For more information, see [Applications, page 9-10](#).
- **Objects.** For more information, see [Object Blocking, page 9-11](#).
- **Web Reputation and Anti-Malware Filtering.** For more information, see [Web Reputation and Anti-Malware, page 9-12](#).

After an Access Policy group is assigned to a request, the control settings for the policy group are evaluated to determine whether to allow, block, or redirect the request. For more information about assigning an Access Policy group to a request, see [Policy Group Membership, page 7-7](#).

Figure 9-3 on page 9-9 shows how the Web Proxy determines which action to take on a request after it has assigned a particular Access Policy to the request.

Figure 9-3 Applying Access Policy Actions

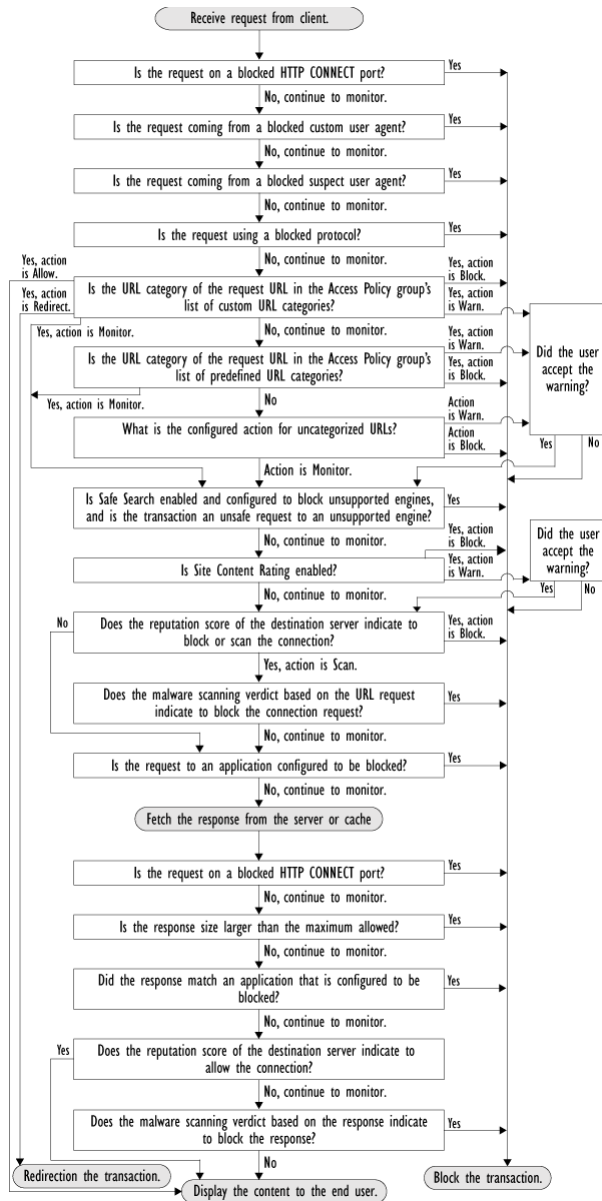

Figure 9-3 on page 9-9 shows two different decision points that involve the web reputation score of the destination server. The web reputation score of the server is evaluated only once, but the result is applied at two different points in the decision flow.

## Protocols and User Agents

You can use the Protocols and User Agents settings on the Access Policies > Protocols and User Agents page to control policy group access to protocols and configure blocking for particular client applications (also known as user agents), such as instant messaging clients, web browsers, and Internet phone services. You can also configure the appliance to tunnel HTTP CONNECT requests on specific ports. With tunneling enabled, the appliance passes HTTP traffic through specified ports without evaluating it.

For more information about blocking user agents, see [Blocking Specific Applications and Protocols](#), page 9-12.

**Figure 9-4** Settings for Controlling Protocols and User Agents

Access Policies: Protocols and User Agents: exampleaccesspolicy



**Note**

When the HTTPS Proxy is enabled, you can only use Decryption Policies to control access to HTTPS transactions. You cannot configure Access Policies on this page to block HTTPS connections.

## URL Categories

AsyncOS for Web allows you to configure how the appliance handles a transaction based on the URL category of a particular HTTP or HTTPS request. Using a predefined category list, you can choose to monitor or block content by category. You can also create custom URL categories and choose to allow, monitor, block, warn, or redirect traffic for a website in the custom category. You can use custom URL categories to create block and allow lists based on destination.

For information about enabling a URL filtering engine, see [Configuring the URL Filtering Engine](#), page 17-4. For information on configuring URL categories in Access Policies, see [Configuring URL Filters for Access Policy Groups](#), page 17-10.

You can also use the Access Policies > URL Categories page to filter adult content by enforcing safe searches and site content ratings. For more information, see [Filtering Adult Content](#), page 17-17.

## Applications

You can use the Access Policies > Applications Visibility and Control page to configure the Web Proxy block or allow applications by application type or a particular application. You can also apply controls to particular application behaviors within a particular application, such as file transfers.

Cisco IronPort Web Usage Controls includes the Application Visibility and Control engine (AVC engine) which allows you to apply deeper controls to particular application types. The AVC engine is an acceptable use policy component that inspects web traffic to gain deeper understanding and control of web traffic used for applications.

For more information on enabling the AVC engine, see [Enabling the AVC Engine, page 18-2](#). For more information on configuring application settings in Access Policies, see [Understanding Application Control Settings, page 18-3](#).

## Object Blocking

You can use the settings on the Access Policies > Objects page to configure the Web Proxy to block file downloads based on file characteristics, such as file size and file type.



### Note

Object blocking does not inspect inside compressed files.

For more information about blocking a specific object or MIME-type, see [Blocking Specific Applications and Protocols, page 9-12](#).



### Note

When you block Microsoft Office files in the Block Object Type section, it is possible that some Microsoft Office files will not be blocked. If you need to be sure to block all Microsoft Office files, add **application/x-ole** in the Block Custom MIME Types field. However, blocking this custom MIME type also blocks all Microsoft Compound Object format types, such as Visio files and some third party applications.

**Figure 9-5** Blocking Object Types

Access Policies: Objects: exampleaccesspolicy

**Edit Objects Blocking Settings**

Define Custom Objects Blocking Settings

**Objects Blocking Settings**

**Object Size**

HTTP/HTTPS Max Download Size:  MB  No Maximum

FTP Max Download Size:  MB  No Maximum

**Block Object Type**

Object and MIME Type Reference

- Archives
- Document Types
- Executable Code
- Installers
- Media
- P2P Metafiles
- Web Page Content
- Miscellaneous

**Custom MIME Types**

Object and MIME Type Reference

Block Custom MIME Types:

(Enter multiple entries on separate lines. Example: audio/x-mpeg3 or audio/\* are valid entries.)

## Web Reputation and Anti-Malware

The Web Reputation and Anti-Malware Filtering policy inherits global settings respective to each component. To customize filtering and scanning for a particular policy group, you can use the Web Reputation and Anti-Malware Settings pull-down menu to customize monitoring or blocking for malware categories based on malware scanning verdicts and to customize web reputation score thresholds.

For more information, see [Web Reputation and Anti-Malware Settings in Access Policies, page 19-11](#).

## Blocking Specific Applications and Protocols

You can configure how the appliance manages some kinds of applications based on the port being used:

- **Port 80.** You can control how the Web Security appliance manages these applications using Access Policies, but only as they are accessed via HTTP tunneling on port 80.
- **Ports other than 80.** You can block these applications on other ports by using the L4 Traffic Monitor.

Use the Web Security Manager > Access Policies page to manage access and monitoring for these types of applications on a more granular (per policy) level. Use the L4 Traffic Monitor to manage access and monitoring on a more global basis.

## Blocking on Port 80

To block access to these types of applications where port 80 is used, you can use the Web Security Manager > Access Policies page. The Access Policies page provides several methods for blocking access. You can block access by clicking on any of the following columns for a particular policy group:

- Protocols and User Agents
- URL Categories
- Objects

You can block access to predefined URL categories such as “Chat and Instant Messaging” and “Peer File Transfer”, or create your own custom URL categories. You can block specific applications based on their “agent patterns” or signatures.

You can apply some or all of these methods on various Access Policies by creating additional Access Policy groups. For details on how to create additional Access Policy groups, see [Creating Access Policies, page 9-5](#).

## Policy: Protocols and User Agents

You can create a rule that blocks a particular user agent based on its pattern using Regular Expressions.

You block access to applications based on their agent pattern similarly for the different Access Policies:

- **User defined policies** — On the Web Security Manager > Access Policies page, click the value in the Protocols and User Agents column for the desired policy. Choose Define Applications Custom Settings.
- **Global Policy** — On the Web Security Manager > Access Policies page, click the value in the Protocols and User Agents column for the Global Policy.



Once you view the Access Policies: Protocols and User Agents: *Policy\_Name* page, add user agent patterns (also called signatures) to the Block Custom User Agents section of the page.

**Figure 9-6** Entering Agent Patterns to Block



**Note**

You can click the Example User Agent Patterns link for a list of some example user agent patterns.

Table 9-2 provides a list of common patterns.

**Table 9-2** Common Application Agent Patterns

Application	Search in Setting	HTTP Header	Signature
AOL Messenger	Request headers	User-Agent	Gecko/
BearShare	Response header	Server	Bearshare
BitTorrent	Request headers	User-Agent	BitTorrent
eDonkey	Request headers	User-Agent	e2dk
Gnutella	Request headers	User-Agent	Gnutella Gnucleus
Kazaa	Request headers	P2P-Agent	Kazaa Kazaaclient:
Kazaa	Request headers	User-Agent	KazaClient Kazaaclient:
Kazaa	Request headers	X-Kazaa-Network	KaZaA
Morpheus	Response header	Server	Morpheus
MSN Messenger	Request headers	User-Agent	MSN Messenger
Trillian	Request headers	User-Agent	Trillian/
Windows Messenger	Request headers	User-Agent	MSMSGSGS
Yahoo Messenger	Request headers	Host	msg.yahoo.com
Yahoo Messenger	Request headers	User-Agent	ymsgr

This is not a comprehensive list, as signatures change occasionally, and new applications are developed. You can find additional signatures at various websites, including the following websites:

- <http://www.user-agents.org/>
- <http://www.useragentstring.com/pages/useragentstring.php>
- <http://www.infosyssec.com/infosyssec/security/useragentstrings.shtml>



**Note**

Cisco IronPort does not maintain, verify, or support the user agent listings at any of these websites.

## Policy: URL Categories

You can specify categories of URLs to block, including the predefined “Chat and Instant Messaging” and “Peer File Transfer” categories. You can also add specific custom URL categories should you want to add a URL that is not already included in the predefined categories. You may then add the custom category to the list of blocked URLs.

For more information about using URL Categories, see [URL Categories, page 9-10](#).

## Policy: Objects

You can block some Peer-to-Peer files directly, via the Access Policies: Objects: Global Policy page.

On the Web Security Manager > Access Policies page, click on the value in the Objects column for the desired policy.

In the Block Object Type section, check any boxes in the P2P Metafiles group. You can add custom MIME (Multipurpose Internet Mail Extensions) types by entering them in the Custom MIME Types field. For example, entering the `application/x-zip` signature blocks ZIP archive files.

## Blocking on Ports Other Than 80

If these applications are using ports other than 80, you may want to block access to a specific server or block of IP addresses to which the client must connect. To manage these applications on other ports, use the L4 Traffic Monitor. The L4 Traffic monitor allows you to restrict access on specific ports. However, the restriction is global, so it will apply to all traffic on that port.

# 10

## Working with External Proxies

---

- [Working with External Proxies Overview, page 10-1](#)
- [Routing Traffic to Upstream Proxies, page 10-1](#)
- [Adding External Proxy Information, page 10-3](#)
- [Evaluating Routing Policy Group Membership, page 10-4](#)
- [Creating Routing Policies, page 10-5](#)

### Working with External Proxies Overview

The Web Security appliance is a proxy-compatible device, and is easily deployed within an existing proxy environment. However, it is recommended that you place the appliance downstream from existing proxy servers, meaning closer to the clients.

You can configure the appliance to work with multiple existing, upstream proxies. Use the Network > Upstream Proxies page to define upstream proxies or to modify existing settings. You define groups of proxies, and you can configure the appliance to use load balancing and failover features when connecting to multiple proxies.

After defining proxy groups, you can create Routing Policies to determine whether the Web Proxy connects to the server identified by the client or to a member of one the proxy groups.

For more information about using Routing Policies to route transactions, see [Routing Traffic to Upstream Proxies, page 10-1](#). For more information about defining external proxies, see [Adding External Proxy Information, page 10-3](#).

### Routing Traffic to Upstream Proxies

When the Web Proxy does not deliver a response from the cache, it can direct client requests directly to the destination server or to an external proxy on the network. You use Routing Policies to create rules that indicate when and to where to direct transactions. A Routing Policy determines to where to pass the client request, either to another proxy (as defined by the proxy group) or to the destination server. It addresses the question, “from where to fetch content?” You might want to create Routing Policies if you have a highly distributed network.

[Figure 10-1](#) shows Routing Policies on the Web Security Manager > Routing Policies page.

**Figure 10-1 Routing Policies****Routing Policies**

Routing Definitions			
Add Policy...			
Order	Members	Routing Destination	Delete
1	LondonOffice Identity: LondonOffice ?	ProxyGroup2 10.8.8.8:3128, 10.8.8.9:3128, 10.8.8.10:3128	🗑️
2	TestLab Identity: TestLab	Direct Connection	🗑️
<b>Global Routing Policy</b>		ProxyGroup1 10.1.1.1:3128, 10.1.1.2:3128	

When you define multiple external proxies in a proxy group, the Web Proxy can use load balancing techniques to distribute requests to different proxies defined in the group. You can choose the following load balancing techniques:

- **None (failover).** The Web Proxy directs transactions to one external proxy in the group. It tries to connect to the proxies in the order they are listed. If one proxy cannot be reached, the Web Proxy attempts to connect to the next one in the list.
- **Fewest connections.** The Web Proxy keeps track of how many active requests are with the different proxies in the group and it directs a transaction to the proxy currently servicing the fewest number of connections.
- **Hash based.** The Web Proxy uses a hash function to distribute requests to the proxies in the group. The hash function uses the proxy ID and URL as inputs so that requests for the same URL are always directed to the same external proxy.
- **Least recently used.** The Web Proxy directs a transaction to the proxy that least recently received a transaction if all proxies are currently active. This setting is similar to round robin except the Web Proxy also takes into account transactions a proxy has received by being a member in a different proxy group. That is, if a proxy is listed in multiple proxy groups, the “least recently used” option is less likely to overburden that proxy.
- **Round robin.** The Web Proxy cycles transactions equally among all proxies in the group in the listed order.

For information about creating Routing Policies, see [Creating Routing Policies, page 10-5](#).

**Note**

If your network contains an upstream proxy that does not support FTP connections, then you must create a Routing Policy that applies to all Identities and to just FTP requests. Configure that Routing Policy to directly connect to FTP servers or to connect to a proxy group whose proxies all support FTP connections.

## Accessing HTTPS Sites using Routing Policies with URL Category Membership Criteria

For transparently redirected HTTPS requests, the Web Proxy must contact the destination server to determine the server name and therefore the URL category in which it belongs. Due to this, when the Web Proxy evaluates Routing Policy Group membership, it cannot yet know the URL category of an HTTPS request because it has not yet contacted the destination server. If the Web Proxy does not know the URL category, it cannot match the transparent HTTPS request to a Routing Policy that uses a URL category as membership criteria.

As a result, transparently redirected HTTPS transactions only match Routing Policies that do not define Routing Policy Group membership criteria by URL category. If all user-defined Routing Policies define their membership by URL category, transparent HTTPS transactions match the Default Routing Policy Group.

## Adding External Proxy Information

To define external proxy information, you create a proxy group. A proxy group is an object that defines a list of proxies and their connection information and the load balancing technique to use when distributing requests to proxies in the group. You can create multiple proxy groups and can define multiple proxies within a group.

AsyncOS for Web allows you to enter the same proxy server information multiple times into the same proxy group. You might want to include the same proxy server multiple times to allow unequal load distribution among the proxies in the proxy group.

**Note**

You can only specify one existing proxy during the System Setup Wizard. AsyncOS creates a proxy group with one proxy using the information you enter in the System Setup Wizard. You can specify additional proxies in the web interface after initial setup.

## Creating Proxy Groups

- 
- Step 1** Navigate to Network > Upstream Proxies, and click **Add Group**.
  - Step 2** Enter a name for the proxy group in the Name field.
  - Step 3** In the Proxy Servers section, define at least one external proxy.
    - a. In the Proxy Address field, enter the hostname or IP address of the proxy server.
    - b. In the Port field, enter the port number used to access the proxy.
    - c. In the Reconnection Attempts field, enter the number of times the Web Proxy should try to connect to the proxy server before ignoring it.
    - d. Optionally, you can define another proxy server by clicking Add Row.
  - Step 4** In the Load Balancing field, choose the method the Web Proxy should use to distribute transactions to the proxies when the group contains multiple proxies.

For more information about the load balancing options, see [Routing Traffic to Upstream Proxies, page 10-1](#).
  - Step 5** In the Failure Handling field, choose how the Web Proxy should handle transactions when all proxies in the group fail.
  - Step 6** Submit and commit your changes.
-

# Evaluating Routing Policy Group Membership

After the Web Proxy assigns an Identity to a client request, it evaluates the request against the other policy types to determine which policy group it belongs for each type. Any request that does not get terminated due to failed authentication gets evaluated against the Routing Policies to determine from where to fetch the data.

Once the Web Proxy assigns a Routing Policy group to a request, it fetches the content from the location configured for the policy group, either from a configured proxy group or directly from the server.

To determine the policy group that a client request matches, the Web Proxy follows a specific process for matching the group membership criteria. During this process, it considers the following factors for group membership:

- **Identity.** Each client request either matches an Identity, fails authentication and is granted guest access, or fails authentication and gets terminated. For more information about evaluating Identity group membership, see [Evaluating Identity Group Membership, page 8-4](#).
- **Authorized users.** If the assigned Identity requires authentication, the user must be in the list of authorized users in the Routing Policy group to match the policy group.
- **Advanced options.** You can configure several advanced options for Routing Policy group membership. Some options (such as proxy port and URL category) can also be defined within the Identity. When an advanced option is configured in the Identity, it is not configurable in the Routing Policy group level.

The information in this section gives an overview of how the appliance matches client requests to Routing Policy groups. For more details about exactly how the appliance matches client requests, see [Matching Client Requests to Routing Policy Groups, page 10-4](#).

The Web Proxy sequentially reads through each policy group in the policies table. It compares the client request status to the membership criteria of the first policy group. If they match, the Web Proxy applies the policy settings of that policy group.

If they do not match, the Web Proxy compares the client request to the next policy group. It continues this process until it matches the client request to a user defined policy group. If it does not match a user defined policy group, it matches the global policy group. When the Web Proxy matches the client request to a policy group or the global policy group, it applies the policy settings of that policy group.

## Matching Client Requests to Routing Policy Groups

[Figure 10-2 on page 10-5](#) shows how the Web Proxy evaluates a client request against the Routing Policy groups.

Figure 10-2 Policy Group Flow Diagram for Routing Policies

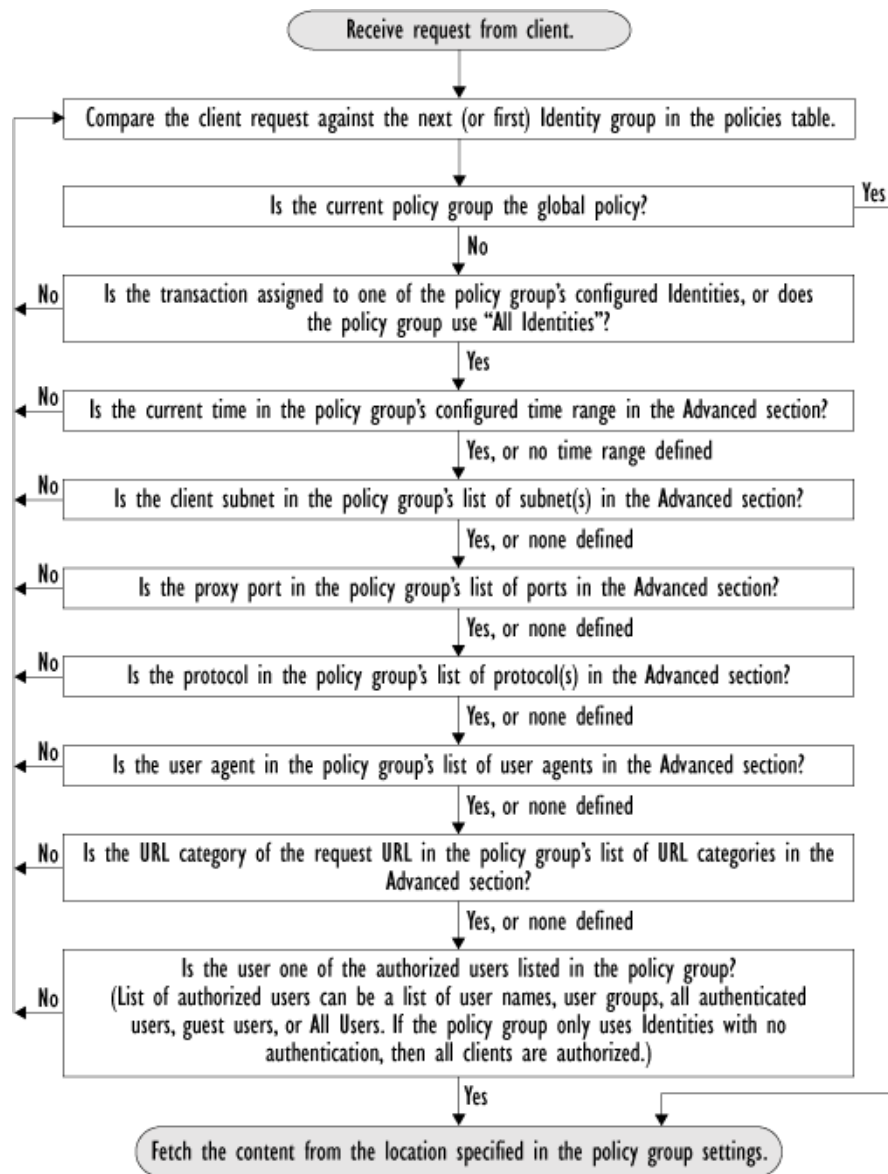

## Creating Routing Policies

You can create Routing Policy groups based on combinations of several criteria, such as Identity or the port used to access the Web Proxy. You must define at least one criterion for policy group membership. When you define multiple criteria, the client request must meet all criteria to match the policy group.

For more information about how the appliance matches a client request with a policy group, see [Evaluating Routing Policy Group Membership](#), page 10-4 and [Matching Client Requests to Routing Policy Groups](#), page 10-4.

You define policy group membership on the Web Security Manager > Routing Policies page.

- 
- Step 1** Navigate to the Web Security Manager > Routing Policies page.
- Step 2** Click **Add Group**.
- Step 3** In the Policy Name field, enter a name for the policy group, and in the Description field, optionally add a description.



---

**Note** Each policy group name must be unique and only contain alphanumeric characters or the space character.

---

- Step 4** In the Insert Above Policy field, choose where in the policies table to place the policy group. When configuring multiple policy groups you must specify a logical order for each group. Carefully order your policy groups to ensure that correct matching occurs.
- Step 5** In the Identities and Users section, choose one or more Identity groups to apply to this policy group. For more information on how to do this, see [Configuring Identities in Other Policy Groups, page 8-22](#).
- Step 6** Optionally, expand the Advanced section to define additional membership requirements.
- Step 7** To define policy group membership by any of the advanced options, click the link for the advanced option and configure the option on the page that appears.

[Table 10-1](#) describes the advanced options you can configure for policy groups.

**Table 10-1 Policy Group Advanced Options**

Advanced Option	Description
Protocols	<p>Choose whether or not to define policy group membership by the protocol used in the client request. Select the protocols to include.</p> <p>“All others” means any protocol not listed above this option.</p> <p><b>Note:</b> When the HTTPS Proxy is enabled, only Decryption Policies apply to HTTPS transactions. You cannot define policy membership by the HTTPS protocol for Access, Routing, Outbound Malware Scanning, Data Security, or External DLP Policies.</p>
Proxy Ports	<p>Choose whether or not to define policy group membership by the proxy port used to access the Web Proxy. Enter one or more port numbers in the Proxy Ports field. Separate multiple ports with commas.</p> <p>For explicit forward connections, this is the port configured in the browser. For transparent connections, this is the same as the destination port. You might want to define policy group membership on the proxy port if you have one set of clients configured to explicitly forward requests on one port, and another set of clients configured to explicitly forward requests on a different port.</p> <p>Cisco recommends only defining policy group membership by the proxy port when the appliance is deployed in explicit forward mode, or when clients explicitly forward requests to the appliance. If you define policy group membership by the proxy port when client requests are transparently redirected to the appliance, some requests might be denied.</p> <p><b>Note:</b> If the Identity associated with this policy group defines Identity membership by this advanced setting, the setting is not configurable at the non-Identity policy group level.</p>



**Table 10-1** Policy Group Advanced Options (continued)

Advanced Option	Description
Subnets	<p>Choose whether or not to define policy group membership by subnet or other addresses.</p> <p>You can choose to use the addresses that may be defined with the associated Identity, or you can enter specific addresses here.</p> <p><b>Note:</b> If the Identity associated with this policy group defines its membership by addresses, then in this policy group you must enter addresses that are a subset of the Identity's addresses. Adding addresses in the policy group further narrows down the list of transactions that match this policy group.</p>
Time Range	<p>Choose whether or not to define policy group membership by a defined time range. Choose the time range from the Time Range field and then choose whether this policy group should apply to the times inside or outside the selected time range.</p> <p>For more information on creating time based policies, see <a href="#">Working with Time Based Policies, page 7-9</a>.</p> <p>For more information on creating time ranges, see <a href="#">Creating Time Ranges, page 7-9</a>.</p>
URL Categories	<p>Choose whether or not to define policy group membership by URL categories. Select the user defined or predefined URL categories.</p> <p><b>Note:</b> If the Identity associated with this policy group defines Identity membership by this advanced setting, the setting is not configurable at the non-Identity policy group level.</p>
User Agents	<p>Choose whether or not to define policy group membership by the user agent used in the client request. You can select some commonly defined browsers, or define your own using regular expressions. Choose whether this policy group should apply to the selected user agents or to any user agent that is not in the list of selected user agents.</p> <p>For more information on creating user agent based policies, see <a href="#">Working with User Agent Based Policies, page 7-10</a>.</p> <p><b>Note:</b> If the Identity associated with this policy group defines Identity membership by this advanced setting, the setting is not configurable at the non-Identity policy group level.</p>
User Location	<p>Choose whether or not to define policy group membership by user location, either remote or local.</p> <p>This option only appears when the Secure Mobility is enabled. For more information, see <a href="#">Achieving Secure Mobility Overview, page 14-1</a>.</p>

**Step 8** Submit your changes.

**Step 9** Configure Routing Policy group control settings to define how the Web Proxy handles transactions.

The new policy group automatically inherits global policy group settings until you configure options for each control setting. For more information, see [Routing Traffic to Upstream Proxies, page 10-1](#).

**Step 10** Submit and commit your changes.



# 11

## Processing HTTPS Traffic

---

- [Overview of Processing HTTPS Traffic, page 11-1](#)
- [Decryption Policies, page 11-2](#)
- [Managing Certificate Validation and Decryption for HTTPS, page 11-7](#)
- [Certificates, page 11-3](#)
- [Enabling the HTTPS Proxy, page 11-13](#)
- [Evaluating Decryption Policy Group Membership, page 11-14](#)
- [Creating Decryption Policies, page 11-16](#)
- [Routing HTTPS Traffic, page 11-19](#)
- [Controlling HTTPS Traffic, page 11-20](#)
- [Bypassing Decryption for Particular Websites, page 11-22](#)
- [Trusted Root Certificates, page 11-22](#)
- [Logging, page 11-23](#)

## Overview of Processing HTTPS Traffic

HTTPS traffic is encrypted. The Web Proxy can pass through encrypted HTTPS traffic, serving as a “man in the middle”, but unless the content is decrypted, the web proxy cannot apply the content-based rules contained within access policies, for example, it cannot block executable files or scan for malware. The HTTPS proxy can decrypt HTTPS traffic and pass it to access policies for the application of content-based policies. The web proxy then applies access policies to the decrypted HTTPS content.

When the HTTPS proxy is enabled, HTTPS-specific rules in access policies, for example, “block HTTPS traffic”, are disabled. The web proxy processes decrypted HTTPS traffic using rules for HTTP.

Decryption policies specify which HTTPS connections to monitor, drop, pass through, or decrypt.

**Note**

**Handle personally identifiable information with care:** If you choose to decrypt an end-user’s HTTPS session, the Web Security appliance access logs and reports may contain personally identifiable information. Cisco recommends that Web Security appliance administrators take care when handling this sensitive information.

You can configure how much URI text is stored in the logs using the `advancedproxyconfig` CLI command and the `HTTPS` subcommand. You can log the entire URI, or a partial form of the URI with the query portion removed. However, even when you choose to strip the query from the URI, personally identifiable information may still remain. configure how much URI text is stored in the logs using the

`advancedproxyconfig` CLI command and the `HTTPS` subcommand. You can log the entire URI, or a partial form of the URI with the query portion removed. However, even when you choose to strip the query from the URI, personally identifiable information may still remain.

Task	Notes
Enable the HTTPS proxy	Selecting Enable HTTPS proxy enables decryption and processing of HTTPS traffic. When you enable the HTTPS proxy,
Generate or upload certificate and private key	Your certificate and private key provide the trust necessary to decrypt content.
Manage trusted and blocked certificates	Manage lists of trusted and blocked certificates over time.
Configure invalid and revoked certificate handling	Specify whether to drop, decrypt, or monitor HTTPS connections that use invalid or revoked certificates.
Create decryption policies	Specify when to monitor, drop, pass through, or decrypt HTTPS connections.

## Decryption Policies

Decryption policies define the handling of HTTPS traffic within the web proxy:

- When to decrypt HTTPS traffic.
- How to handle requests that use invalid or revoked security certificates.

The appliance can perform any of the following actions on an HTTPS connection request:

- **Monitor.** Monitor is an intermediary action that indicates the Web Proxy should continue evaluating the transaction against the other control settings to determine which final action to ultimately apply.
- **Drop.** The appliance drops the connection and does not pass the connection request to the server. The appliance does not notify the user that it dropped the connection. You might want to drop connections to third party proxies that allow users on the network to bypass the organization's acceptable use policies.
- **Pass through.** The appliance passes through the connection between the client and the server without inspecting the traffic content. You might want to pass through connections to trusted secure sites, such as well known banking and financial institutions.
- **Decrypt.** The appliance allows the connection, but inspects the traffic content. It decrypts the traffic and applies Access Policies to the decrypted traffic as if it were a plaintext HTTP connection. By decrypting the connection and applying Access Policies, you can scan the traffic for malware. You might want to decrypt connections to third party email providers, such as gmail or hotmail. For more information about how the appliance decrypts HTTPS traffic, see [Certificates, page 11-3](#).

All actions except Monitor are final actions the Web Proxy applies to a transaction. A final action is an action that causes the Web Proxy to stop evaluating the transaction against other control settings.

For example, if a Decryption Policy is configured to monitor invalid server certificates, the Web Proxy makes no final decision on how to handle the HTTPS transaction if the server has an invalid certificate. If a Decryption Policy is configured to block servers with a low web reputation score, then any request to a server with a low reputation score is dropped without considering the URL category actions.

**Note**

Cisco recommends creating fewer, more general Decryption Policy groups that apply to all users or fewer, larger groups of users on the network. Then, if you need to apply more granular control to decrypted HTTPS traffic, use more specific Access Policy groups. For more information about Access Policy groups, see [Block, Allow or Redirect Transaction Requests, page 9-1](#).

[Figure 11-5 on page 11-21](#) shows the order the Web Proxy uses when evaluating control settings for Decryption Policies. [Figure 9-3 on page 9-9](#) shows the order the Web Proxy uses when evaluating control settings for Access Policies.

## Certificates

The HTTPS proxy uses the root certificates and private key files that you upload to the appliance to decrypt traffic. The root certificate and private key files you upload to the appliance must be in PEM format.

You can enter root certificate information in the following ways:

- **Generate.** You can enter some basic organization information and then click a button so the appliance generates the rest of the certificate and a private key. You might want to generate a certificate and key when your organization does not have a certificate and key in use, or when it wants to create a new and unique certificate and key.
- **Upload.** You can upload a certificate file and its matching private key file created outside of the appliance. You might want to upload a certificate and key file if the clients on the network already have the root certificates on their machines.  
The certificate and key files you upload must be in PEM format. DER format is not supported. For more information about converting a DER formatted certificate or key to PEM format, see [Converting Certificate and Key Formats, page A-9](#).

**Note**

**Mozilla Firefox browsers:** The certificate you upload must contain “basicConstraints=CA:TRUE” to work with Mozilla Firefox browsers. This constraint allows Firefox to recognize the root certificate as a trusted root authority.

For more information about how to generate or upload a certificate and key, see [Enabling the HTTPS Proxy, page 11-13](#).

However, typically, the root certificate information you generate or upload in the appliance is not listed as a trusted root certificate authority in client applications. By default in most web browsers, when users send HTTPS requests, they will see a warning message from the client application informing them that there is a problem with the website’s security certificate. Usually, the error message says that the website’s security certificate was not issued by a trusted certificate authority or the website was certified by an unknown authority. Some other client applications do not show this warning message to users nor allow users to accept the unrecognized certificate.

**Note**

You can also upload an intermediate certificate that has been signed by a root certificate authority. When the Web Proxy mimics the server certificate, it sends the uploaded certificate along with the mimicked certificate to the client application. That way, as long as the intermediate certificate is signed by a root certificate authority that the client application trusts, the application will trust the mimicked server

certificate, too. You might want to upload an intermediate certificate if your organization uses its own root certificate authority, but does not want to upload the root certificate to the Web Security appliance for security reasons.

Figure 11-1 on page 11-4 shows an example error message when a users sends an HTTPS request through Netscape Navigator.

**Figure 11-1 Unknown Certificate Authority Error Message**

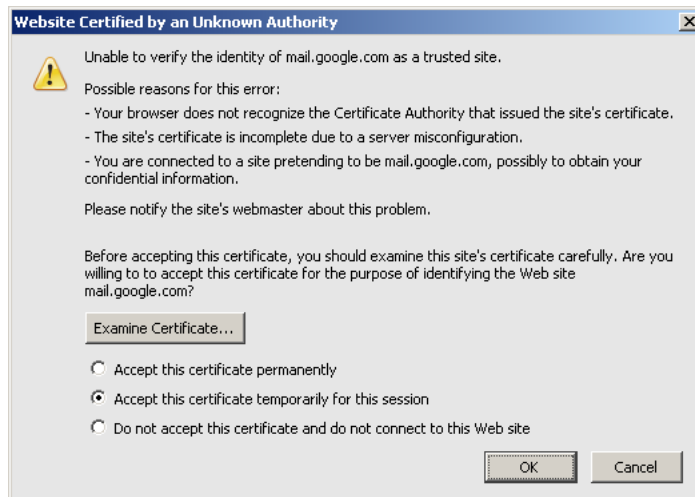

Typically, users can view the certificate and use the information in the certificate to choose whether or not to allow the secure connection with this website. In Figure 11-1, you can view the certificate contents by clicking **Examine Certificate**.

Figure 11-2 on page 11-5 shows an example root certificate issued by the appliance.

Figure 11-2 Certificate Issued by Web Security Appliance

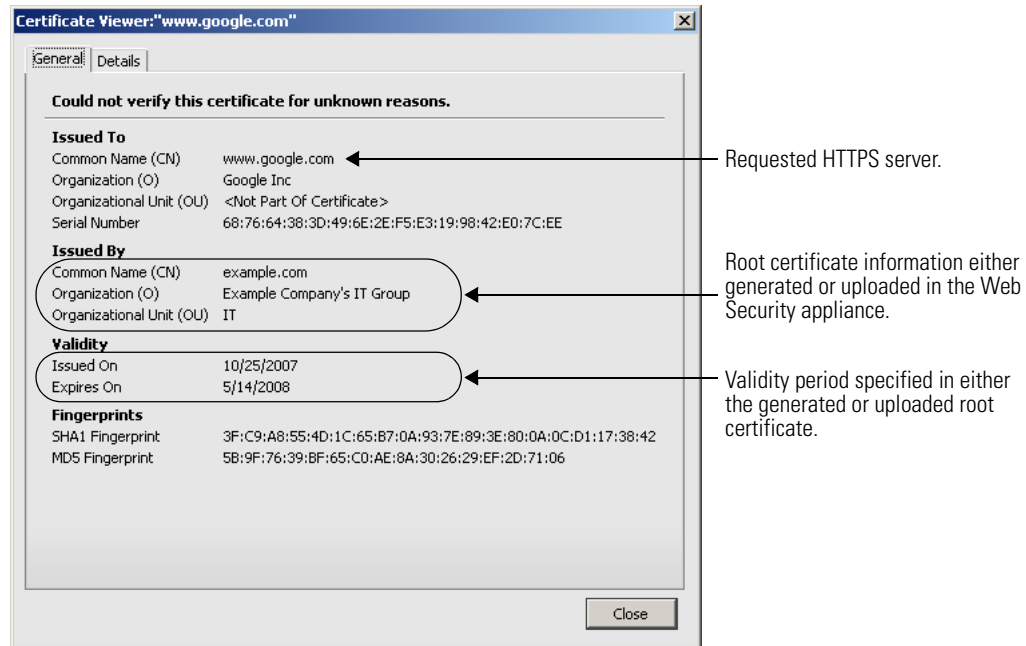

You can choose how to handle the root certificates issued by the Web Security appliance:

- **Inform users to accept the root certificate.** You can inform the users in your organization what the new policies are at the company and tell them to accept the root certificate supplied by the organization as a trusted source.
- **Add the root certificate to client machines.** You can add the root certificate to all client machines on the network as a trusted root certificate authority. This way, the client applications automatically accept transactions with the root certificate. To verify you distribute the root certificate the appliance is using, you can download the root certificate from the Security Services > HTTPS Proxy page. Click **Edit Settings**, and then click the Download Certificate link for either the generated or uploaded certificate.

You might want to download the root certificate from the appliance if a different person uploaded the root certificate to the appliance and you want to verify you distribute the same root certificate to the client machines.



**Note** To reduce the possibility of client machines getting a certificate error, submit the changes after you generate or upload the root certificate to the Web Security appliance, then distribute the certificate to client machines, and then commit the changes to the appliance.

## Authentication and HTTPS Connections

Authentication at the HTTPS connection layer is available for these types of requests:

- explicit requests with
  - secure client authentication disabled or
  - secure client authentication enabled and an IP-based surrogate

- transparent requests with
  - IP-based surrogate, decryption for authentication enabled or
  - IP-based surrogate, client previously authenticated using an HTTP request

## Decryption with the AVC Engine

The HTTPS Proxy can decrypt HTTPS connections to web applications. This allows the AVC engine to more accurately detect and block web applications that use HTTPS. These web applications may use web browsers or other client applications, such as instant messaging applications.

However, to ensure that all applications work properly when HTTPS connections are decrypted, you must add the root certificate for signing to all client machines on the network as a trusted root certificate authority. For example, on Windows machines, you must install the root certificate into Internet Explorer for many instant messaging client applications to work, such as Yahoo Instant Messenger, MSN Messenger, and Google Talk.

## Decryption with AOL Instant Messenger

Most AOL Instant Messenger (AIM) client applications do not allow you to add root certificates to their list of trusted certificates. Because you cannot add the appliance root certificate for signing to AIM client applications, AIM users are unable to log into AIM when the HTTPS connection to the AIM server is decrypted. Decryption to AIM servers might occur if the web reputation filters are configured to decrypt traffic to servers with the reputation score equal to the AIM server, or if a Decryption Policy is configured to decrypt all traffic.

To allow users to log into AIM, you must ensure that HTTPS traffic to the AIM servers are never decrypted and instead are passed through.

**Note**

---

Once users are logged into AIM, all instant messenger traffic uses HTTP and is subject to the configured Access Policies.

---

To pass through HTTPS traffic to AIM servers:

- 
- Step 1** Create a custom URL category in the first position of custom URL categories and enter the following addresses:
- aimpro.premiumservices.aol.com
  - bos.oscar.aol.com
  - kdc.uas.aol.com
  - buddyart-d03c-sr1.blue.aol.com
  - 205.188.8.207
  - 205.188.248.133
  - 205.188.13.36
  - 64.12.29.131



- Step 2** Create a Decryption Policy and use the custom URL category created in [Step 1](#) as part of the policy group membership. Depending on the other Decryption Policies configured, you might want to place this Decryption Policy at the top of the list.
  - Step 3** Configure the Decryption Policy to pass through all traffic to the custom URL category.
  - Step 4** Choose pass through as the default action for the Decryption Policy.
  - Step 5** Submit and commit your changes.
- 

## Managing Certificate Validation and Decryption for HTTPS

The Web Security appliance validates certificates before inspecting and decrypting content.

### Valid Certificates

Qualities of a valid certificate:

- **Not expired.** The certificate's validity period includes the current date.
- **Recognized certificate authority.** The issuing certificate authority is included in the list of trusted certificate authorities stored on the Web Security appliance.
- **Valid signature.** The digital signature was properly implemented based on cryptographic standards.
- **Consistent naming.** The common name matches the hostname specified in the HTTP header.
- **Not revoked.** The issuing certificate authority has not revoked the certificate.

#### Related Topics

- [Managing Certificate Validation and Decryption for HTTPS, page 11-7](#)
- [Configuring Invalid Certificate Handling, page 11-10](#)
- [Options for Certificate Revocation Status Checking, page 11-11](#)
- [Enabling Real-Time Revocation Status Checking, page 11-12](#)

### Invalid Certificate Handling

The appliance can perform one of the following actions for invalid server certificates:

- **Drop.** The appliance drops the connection and does not notify the client. This is the most restrictive option.
- **Decrypt.** The appliance allows the connection, but inspects the traffic content. It decrypts the traffic and applies Access Policies to the decrypted traffic as if it were a plaintext HTTP connection.
- **Monitor.** The appliance does not drop the connection, and instead it continues comparing the server request with the Decryption Policy groups. When an invalid server certificate is monitored, the errors in the certificate are maintained and passed along to the end-user. This is the least restrictive option.

#### Related topics

- [Certificates, page 11-3](#)

## Certificates that are Invalid for Multiple Reasons

For server certificates that are invalid due to both an unrecognized root authority and an expired certificate, the HTTPS proxy performs the action that applies to unrecognized root authorities.

In all other cases, for server certificates that are invalid for multiple reasons simultaneously, the HTTPS Proxy performs actions in order from the most restrictive action to the least restrictive action.

## Untrusted Certificate Warnings for Decrypted Connections

When the Web Security appliance encounters an invalid certificate and is configured to decrypt the connection, AsyncOS creates an untrusted certificate that requires the end-user to accept or reject the connection. The common name of the certificate is “Untrusted Certificate Warning.”

Adding this untrusted certificate to the list of trusted certificates will remove the end user’s option to accept or reject the connection.

When AsyncOS generates one of these certificates, it creates a proxy log entry with the text “Signing untrusted key” or “Signing untrusted cert”.

## Enabling HTTPS Certificate Validation and Content Decryption

- 
- Step 1** Navigate to the Security Services > HTTPS Proxy page, and click **Enable and Edit Settings**.
  - Step 2** Read the terms of the HTTPS Proxy License Agreement, and click **Accept**.
  - Step 3** Verify the Enable HTTPS Proxy field is enabled.
  - Step 4** Specify the ports for which the appliance should serve as HTTPS Proxy. Separate multiple port numbers with commas. Port 443 is the default port.



### Note

The maximum number of ports for which the Web Security appliance can serve as proxy is 30, which includes both HTTP and HTTPS. See [Configuring the Web Proxy, page 5-3](#), for information about specifying the ports for which the appliance serves as HTTP proxy.

---

- Step 5** Either upload or generate a root/signing certificate to use for decryption.



### Note

If the appliance has both an uploaded certificate and key pair and a generated certificate and key pair, it only uses the certificate and key pair currently selected in the Root Certificate for Signing section.

---



### Related topics

- [Uploading a Root Certificate and Key, page 11-9](#)
- [Generating a Certificate and Key, page 11-9](#)

## Uploading a Root Certificate and Key

### Before you begin

- Enable the HTTPS Proxy. [Enabling HTTPS Certificate Validation and Content Decryption, page 11-8.](#)

- 
- Step 1** Navigate to the **Security Services > HTTPS Proxy** page.
- Step 2** Click **Edit Settings**.
- Step 3** Select **Use Uploaded Certificate and Key**.
- Step 4** Click **Browse** for the Certificate field to navigate to the certificate file stored on the local machine.  
If the file you upload contains multiple certificates or keys, the Web Proxy uses the first certificate or key in the file.
-  **Note** The certificate file must be in PEM format. DER format is not supported.
- 
- Step 5** Click **Browse** for the Key field to navigate to the private key file.
-  **Note** The key length must be 512, 1024, or 2048 bits. Also, the private key file must be in PEM format. DER format is not supported.
- 
- Step 6** Select **Key is Encrypted** if the key is encrypted.
- Step 7** Click **Upload Files** to transfer the certificate and key files to the Web Security appliance.  
The uploaded certificate information is displayed on the Edit HTTPS Proxy Settings page.
- Step 8** (Optional) Click **Download Certificate** so you can transfer it to the client applications on the network.
- 

## Generating a Certificate and Key

### Before you begin

- Enable the HTTPS Proxy. [Enabling HTTPS Certificate Validation and Content Decryption, page 11-8.](#)

- 
- Step 1** Navigate to the **Security Services > HTTPS Proxy** page.
- Step 2** Click **Edit Settings**.
- Step 3** Select **Use Generated Certificate and Key**.
- Step 4** Click **Generate New Certificate and Key**.
- Step 5** In the Generate Certificate and Key dialog box, enter the information to display in the root certificate.  
You can enter any ASCII character except the forward slash ( / ) in the **Common Name** field.
- Step 6** Click **Generate**. The Web Security appliance generates the certificate with the data you entered and generates a key.
- Step 7** The generated certificate information is displayed on the Edit HTTPS Proxy Settings page.

- Step 8** (Optional) Click **Download Certificate** so you can transfer it to the client applications on the network.
- Step 9** (Optional) Click the **Download Certificate Signing Request** link, so you can submit the Certificate Signing Request (CSR) to a certificate authority (CA).
- Step 10** (Optional) Upload the signed certificate to the Web Security appliance after receiving it back from the CA. You can do this at anytime after generating the certificate on the appliance.
- Step 11** Submit and commit changes.

---

#### Related topics

- [Uploading a Root Certificate and Key, page 11-9.](#)

## Configuring Decryption Options

#### Before you begin

- Verify that the HTTPS proxy is enabled as described in [Enabling HTTPS Certificate Validation and Content Decryption, page 11-8](#)

- Step 1** Navigate to the **Security Services > HTTPS Proxy** page.
- Step 2** Click **Edit Settings**.
- Step 3** Enable the decryption options.

Decryption Option	Description
Decrypt for Authentication	For users who have not been authenticated prior to this HTTPS transaction, allow decryption for authentication.
Decrypt for End-User Notification	Allow decryption so that AsyncOS can display the end-user notification.  <b>Note</b> If the certificate is invalid and invalid certificates are set to drop, when running a policy trace, the first logged action for the transaction will be “decrypt”.
Decrypt for End-User Acknowledgement	For users who have not acknowledged the web proxy prior to this HTTPS transaction, allow decryption so that AsyncOS can display the end-user acknowledgement.
Decrypt for Application Detection	Enhances the ability of AsyncOS to detect HTTPS applications.

## Configuring Invalid Certificate Handling

#### Before you begin

- Verify that the HTTPS proxy is enabled as described in [Enabling HTTPS Certificate Validation and Content Decryption, page 11-8](#)

- Step 1** Navigate to the **Security Services > HTTPS Proxy** page.

**Step 2** Click **Edit Settings**.

**Step 3** For each type of certificate error, define the proxy response.

Certificate Error Type	Description
Expired	The current date falls outside of the range of validity for the certificate.
Mismatched hostname	<b>Note</b> The hostname in the certificate does not match the hostname the client was trying to access. This might happen during a “man in the middle attack,” or when a server redirects a request to a different URL. For example, <code>http://mail.google.com</code> gets redirected to <code>http://www.gmail.com</code> . The Web Proxy can only perform hostname match when it is deployed in explicit forward mode. When it is deployed in transparent mode, it does not know the hostname of the destination server (it only knows the IP address), so it cannot compare it to the hostname in the server certificate.
Unrecognized root authority/issuer	Either the root authority or an intermediate certificate authority is unrecognized.
Invalid signing certificate	There was a problem with the signing certificate, for example, a failure to verify or decrypt the signature.
Invalid leaf certificate	There was a problem with the leaf certificate, for example, a rejection, decoding, or mismatch problem.
All other error types	Most other error types are due to the appliance not being able to complete the SSL handshake with the HTTPS server. For more information about additional error scenarios for server certificates, see <a href="http://www.openssl.org/docs/apps/verify.html">http://www.openssl.org/docs/apps/verify.html</a> .
Proxy Response Type	Description
Drop	Drop the connection.
Decrypt	Decrypt the content and apply access policies as if this was an HTTP connection.
Monitor	Do not take determinative action based on this certificate error. Continue validation services.

For more information about handling invalid server certificates, see [Certificates, page 11-3](#).

**Step 4** Submit and commit changes.

## Options for Certificate Revocation Status Checking

To determine whether the issuing certificate authority has revoked a certificate, the Web Security appliance can check with the issuing certificate authority in these ways:

- **Certificate Revocation List (Comodo certificates only).** The Web Security appliance checks Comodo's certificate revocation list. Comodo maintains this list, updating it according to their own policies. Depending on when it was last updated, the certificate revocation list may be out of date at the time the Web Security appliance checks it.
- **Online Certificate Status Protocol (OCSP).** The Web Security appliance checks the revocation status with the issuing certificate authority in real time. If the issuing certificate authority supports OCSP, the certificate will include a URL for real-time status checking. This feature is enabled by default for fresh installations and disabled by default for updates.

**Note**

The Web Security appliance only performs the OCSP query for certificates that it determines to be valid in all other respects and that include the OCSP URL.

**Related Topics**

- [Enabling Real-Time Revocation Status Checking, page 11-12](#)
- [Configuring Invalid Certificate Handling, page 11-10](#)

## Enabling Real-Time Revocation Status Checking

**Before you Begin**

- Ensure the HTTPS Proxy is enabled. See [Enabling the HTTPS Proxy, page 11-13](#)

- 
- Step 1** Navigate to Security Services > HTTPS Proxy.
- Step 2** Click Edit Settings.
- Step 3** Select Enable Online Certificate Status Protocol (OCSP).
- Step 4** Configure the OCSP Result Handling properties,  
Cisco recommends configuring the OCSP Result Handling options to the same actions as Invalid Certificate Handling options. For example, if you set Expired Certificate to Monitor, configure Revoked Certificate to monitor.
- Step 5** (Optional) Expand the Advanced configuration section and configure the settings described in [Table 11-1](#).

**Table 11-1** OCSP Configuration Fields

Field Name	Description
<b>OCSP Valid Response Cache Timeout</b>	Time to wait before rechecking a valid OCSP response in seconds (s), minutes (m), hours (h), or days (d). Default unit is seconds. Valid range is from 1 second to 7 days.
<b>OCSP Invalid Response Cache Timeout</b>	Time to wait before rechecking an invalid OCSP response in seconds (s), minutes (m), hours (h), or days (d). Default unit is seconds. Valid range is from 1 second to 7 days.
<b>OCSP Network Error Cache Timeout</b>	Time to wait before attempting to contact the OCSP responder again after failing to get a response in seconds (s), minutes (m), hours (h), or days (d). Valid range from 1 second to 24 hours.

Field Name	Description
<b>Allowed Clock Skew</b>	Maximum allowed difference in time settings between the Web Security appliance and the OCSP responder in seconds (s) or minutes (m). Valid range from 1 second to 60 minutes.
<b>Maximum Time to Wait for OCSP Response</b>	Maximum time to wait for a response from the OCSP responder. Valid range is from 1 second to 10 minutes. Specify a shorter duration to reduce delays in end user access to HTTPS requests in the event that the OCSP responder is unavailable.
<b>Use upstream proxy for OCSP checking</b>	Group Name of the upstream proxies.
<b>Servers exempt from upstream proxy</b>	IP addresses or hostnames of the servers to exempt. May be left blank.

## Enabling the HTTPS Proxy

To monitor and decrypt HTTPS traffic, you must enable the HTTPS Proxy on the Security Services > HTTPS Proxy page. When you enable the HTTPS Proxy, you must configure what the appliance uses for a root certificate when it sends self-signed server certificates to the client applications on the network. You can upload a root certificate and key that your organization already has, or you can configure the appliance to generate a certificate and key with information you enter.

Once the HTTPS Proxy is enabled, all HTTPS policy decisions are handled by Decryption Policies. You can no longer define Access and Routing Policy group membership by HTTPS, nor can you configure Access Policies to block HTTPS transactions. If some Access and Routing Policy group memberships are defined by HTTPS and if some Access Policies block HTTPS, then when you enable the HTTPS Proxy those Access and Routing Policy groups become disabled. You can choose to enable the policies at any time, but all HTTPS related configurations are removed.

Also on this page, you can configure what the appliance does with HTTPS traffic when the server certificate is invalid.



### Note

For information on importing a custom root authority certificate, see [Trusted Root Certificates](#), page 11-22.

To enable the HTTPS Proxy:

- Step 1** Navigate to the Security Services > HTTPS Proxy page, and click **Enable and Edit Settings**.  
The HTTPS Proxy License Agreement appears.
- Step 2** Read the terms of the HTTPS Proxy License Agreement, and click **Accept**.
- Step 3** Verify the Enable HTTPS Proxy field is enabled.
- Step 4** In the HTTPS Ports to Proxy field, enter the ports the appliance should check for HTTPS traffic. Port 443 is the default port.



### Note

In deployments using WCCP, the maximum number of port entries is 30 for HTTP and HTTPS ports combined. You can use port ranges to reduce the number of entries. You can use both port numbers and port ranges. Example: 443, 3128, 14001-14015.

**Step 5** In the HTTPS Transparent Request section, choose how the Web Proxy handles transparently redirected HTTPS transactions it receives before an HTTP request that was authenticated using an identity with an IP-based surrogate. Select one of the following options:

- Decrypt the HTTPS request and redirect for authentication
- Deny the HTTPS request

This setting only applies to transactions that use IP address as the authentication surrogate and when the user has not yet been authenticated.

For more information, see [Understanding How Authentication Affects HTTPS and FTP over HTTP Requests](#), page 8-6.



---

**Note** This field only appears when the appliance is deployed in transparent mode.

---

**Step 6** In the Applications that Use HTTPS section, choose whether to enable decryption for enhanced application visibility and control.

Enabling this setting allows the Web Proxy to detect applications that use HTTPS with better accuracy. This setting supersedes the “Pass Through” decision made by the Web Reputation Filters as configured in the Decryption Policies. However, the URL category decision still applies.



---

**Note** Decryption may cause some applications to fail unless the root certificate for signing is installed on the client. For more information on the appliance root certificate, see .

---

**Step 7** Submit and commit your changes.

---

#### Related topics

- [Certificates](#), page 11-3
- [Decryption with the AVC Engine](#), page 11-6

## Evaluating Decryption Policy Group Membership

After the Web Proxy assigns an Identity to a client request, it evaluates the request against the other policy types to determine which policy group it belongs for each type.

The Web Proxy applies the configured policy control settings to a client request based on the client request’s policy group membership.

To determine the policy group that a client request matches, the Web Proxy considers the following factors for group membership:

- **Identity.** Each client request either matches an Identity, fails authentication and is granted guest access, or fails authentication and gets terminated. For more information about evaluating Identity group membership, see [Evaluating Identity Group Membership](#), page 8-4.
- **Authorized users.** If the assigned Identity requires authentication, the user must be in the list of authorized users in the Decryption Policy group to match the policy group.



- **Advanced options.** You can configure several advanced options for Decryption Policy group membership. Some of the options (such as proxy port, and URL category) can also be defined within the Identity. When an advanced option is configured in the Identity, it is not configurable in the Decryption Policy group level.

The information in this section gives an overview of how the appliance matches client requests to Decryption Policy groups. For more details about exactly how the appliance matches client requests, see [Matching Client Requests to Decryption Policy Groups, page 11-15](#).

The Web Proxy sequentially reads through each policy group in the policies table. It compares the client request status to the membership criteria of the first policy group. If they match, the Web Proxy applies the policy settings of that policy group.

If they do not match, the Web Proxy compares the client request to the next policy group. It continues this process until it matches the client request to a user defined policy group. If it does not match a user defined policy group, it matches the global policy group. When the Web Proxy matches the client request to a policy group or the global policy group, it applies the policy settings of that policy group.

## Matching Client Requests to Decryption Policy Groups

[Figure 11-3 on page 11-16](#) shows how the Web Proxy evaluates a client request against the Decryption Policy groups.

Figure 11-3 Policy Group Flow Diagram for Decryption Policies

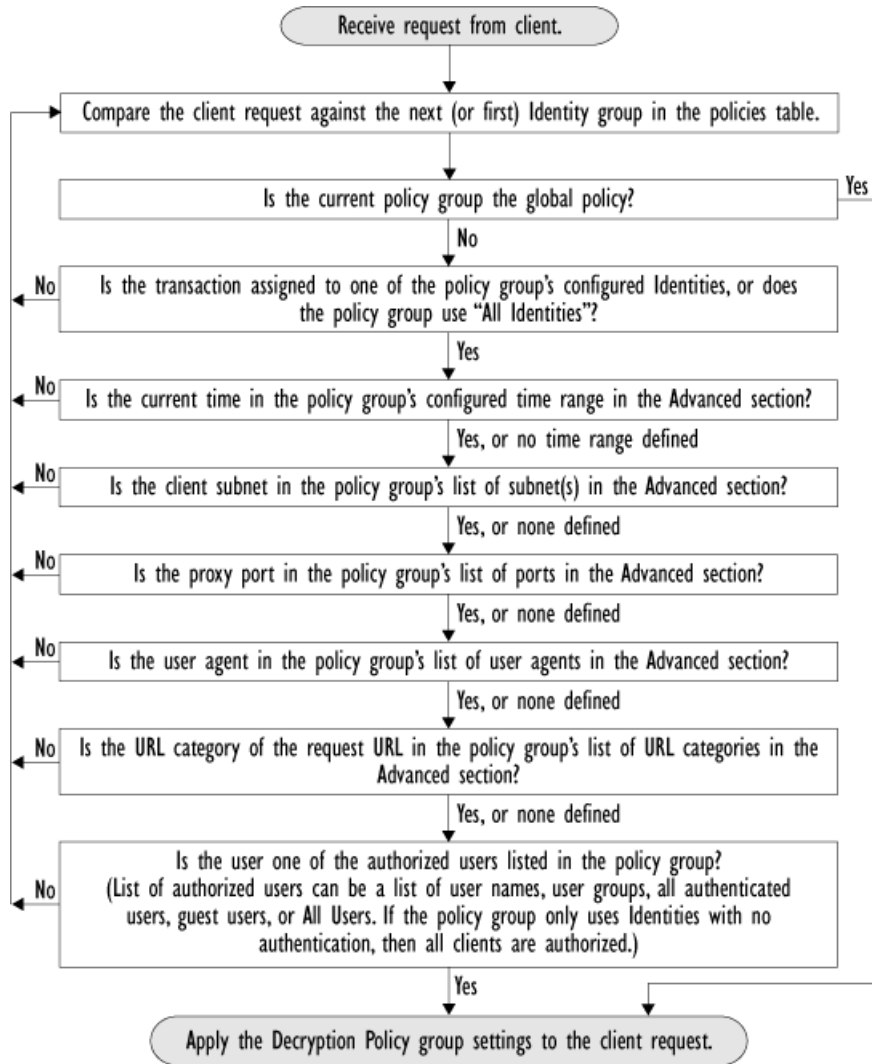

## Creating Decryption Policies

You can create Decryption Policy groups based on combinations of several criteria, such as Identity or the URL category of the destination site. You must define at least one criterion for policy group membership. When you define multiple criteria, the client request must meet all criteria to match the policy group.

For more information about how the appliance matches a client request with a policy group, see [Evaluating Decryption Policy Group Membership, page 11-14](#) and [Matching Client Requests to Decryption Policy Groups, page 11-15](#).

You define policy group membership on the Web Security Manager > Decryption Policies page.

- Step 1** Navigate to the Web Security Manager > Decryption Policies page.
- Step 2** Click **Add Policy**.

**Step 3** In the Policy Name field, enter a name for the policy group, and in the Description field, optionally add a description.



**Note** Each policy group name must be unique and only contain alphanumeric characters or the space character.

**Step 4** In the Insert Above Policy field, choose where in the policies table to place the policy group. When configuring multiple policy groups you must specify a logical order for each group. Carefully order your policy groups to ensure that correct matching occurs.

**Step 5** In the Identities and Users section, choose one or more Identity groups to apply to this policy group.



**Note** If the Identity requires authentication, then authentication information may not be available when a user tries to connect to an HTTPS server. For more information on how HTTPS and authentication work together, see [Understanding How Authentication Affects HTTPS and FTP over HTTP Requests](#), page 8-6.

For more information on how to do this, see [Configuring Identities in Other Policy Groups](#), page 8-22.

**Step 6** Optionally, expand the Advanced section to define additional membership requirements.

<p>Advanced</p>	<p>Use the Advanced options to define or edit membership by proxy port, subnet, Time Range, destination (URL Category), User Agents, or User Location.</p> <p>The following advanced membership criteria have been defined:</p> <p><b>Proxy Ports:</b> None Selected</p> <p><b>Subnets:</b> None Selected</p> <p><b>Time Range:</b> None Selected</p> <p><b>URL Categories:</b> None Selected</p> <p><b>User Agents:</b> None Selected</p> <p><b>User Location:</b> None Selected</p>
-----------------	---

**Step 7** To define policy group membership by any of the advanced options, click the link for the advanced option and configure the option on the page that appears.

Table 11-2 describes the advanced options you can configure for Decryption Policy groups.

**Table 11-2** Decryption Policy Group Advanced Options

Advanced Option	Description
Proxy Ports	<p>Choose whether or not to define policy group membership by the proxy port used to access the Web Proxy. Enter one or more port numbers in the Proxy Ports field. Separate multiple ports with commas.</p> <p>For explicit forward connections, this is the port configured in the browser. For transparent connections, this is the same as the destination port. You might want to define policy group membership on the proxy port if you have one set of clients configured to explicitly forward requests on one port, and another set of clients configured to explicitly forward requests on a different port.</p> <p>Cisco recommends only defining policy group membership by the proxy port when the appliance is deployed in explicit forward mode, or when clients explicitly forward requests to the appliance. When you define policy group membership by the proxy port when clients requests get transparently redirected to the appliance, some requests might be denied.</p> <p><b>Note:</b> If the Identity associated with this policy group defines Identity membership by this advanced setting, the setting is not configurable at the non-Identity policy group level.</p>
Subnets	<p>Choose whether or not to define policy group membership by subnet or other addresses.</p> <p>You can choose to use the addresses that may be defined with the associated Identity, or you can enter specific addresses here.</p> <p><b>Note:</b> If the Identity associated with this policy group defines its membership by addresses, then in this policy group you must enter addresses that are a subset of the Identity's addresses. Adding addresses in the policy group further narrows down the list of transactions that match this policy group.</p>
Time Range	<p>Choose whether or not to define policy group membership by a defined time range. Choose the time range from the Time Range field and then choose whether this policy group should apply to the times inside or outside the selected time range.</p> <p>For more information on creating time based policies, see <a href="#">Working with Time Based Policies, page 7-9</a>.</p> <p>For more information on creating time ranges, see <a href="#">Creating Time Ranges, page 7-9</a>.</p>
URL Categories	<p>Choose whether or not to define policy group membership by URL categories. Select the user defined or predefined URL categories.</p> <p><b>Note:</b> If the Identity associated with this policy group defines Identity membership by this advanced setting, the setting is not configurable at the non-Identity policy group level.</p>

**Table 11-2** Decryption Policy Group Advanced Options (continued)

Advanced Option	Description
User Agents	<p>Choose whether or not to define policy group membership by the user agent used in the client request. You can select some commonly defined browsers, or define your own using regular expressions. Choose whether this policy group should apply to the selected user agents or to any user agent that is not in the list of selected user agents.</p> <p>For more information on creating user agent based policies, see <a href="#">Working with User Agent Based Policies, page 7-10</a>.</p> <p><b>Note:</b> If the Identity associated with this policy group defines Identity membership by this advanced setting, the setting is not configurable at the non-Identity policy group level.</p>
User Location	<p>Choose whether or not to define policy group membership by user location, either remote or local.</p> <p>This option only appears when the Secure Mobility is enabled. For more information, see <a href="#">Achieving Secure Mobility Overview, page 14-1</a>.</p>

- Step 8** Submit your changes.
- Step 9** Configure Decryption Policy group control settings to define how the Web Proxy handles transactions. The new policy group automatically inherits global policy group settings until you configure options for each control setting. For more information, see [Controlling HTTPS Traffic, page 11-20](#).
- Step 10** Submit and commit your changes.

## Routing HTTPS Traffic

The ability of AsyncOS to route HTTPS transactions based on information stored in client headers is limited and is different for transparent and explicit HTTPS.

### Transparent HTTPS

In the case of transparent HTTPS, AsyncOS does not have access to information in the client headers. Therefore, AsyncOS cannot enforce routing policies that rely on information in client headers. For example, for transparent HTTPS transactions, AsyncOS does not have access to the username in the HTTPS client header and therefore it cannot match a routing policy based on username. In this case, AsyncOS uses the default routing policy.

### Explicit HTTPS

In the case of explicit HTTPS, AsyncOS has access to the following information in client headers:

- URL
- Destination port number

Therefore, for explicit HTTPS transactions, it is possible to match a routing policy based on URL or port number.

## Controlling HTTPS Traffic

After the Web Security appliance assigns an HTTPS connection request to a Decryption Policy group, the connection request inherits the control settings of that policy group. The control settings of the Decryption Policy group determine whether the appliance decrypts, drops, or passes through the connection. For more information about the actions the appliance can take on an HTTPS request, see [Overview of Processing HTTPS Traffic, page 11-1](#).

Configure control settings for Decryption Policy groups on the Web Security Manager > Decryption Policies page.

[Figure 11-4](#) shows where you can configure control settings for the Decryption Policy groups.

**Figure 11-4** Decryption Policies Table

### Decryption Policies

Policies					
Add Policy...					
Order	Group (?)	URL Categories	Web Reputation	Default Action	Delete
1	ExampleDP1 Identity: NTLMUsers	(global policy)	(global policy)	(global policy)	
	<b>Global Policy</b> Identity: All	Monitor: 66	Enabled	Decrypt	

Policy Disabled

(When enabled, authentication is applicable to forward connections and pre-established transparent IP-based credentials only.)

You can configure the following settings to determine what action to take on the HTTPS connection:

- **URL categories.** You can configure the action to take on HTTPS requests for each predefined and custom URL category. Click the link under the URL Categories column for the policy group you want to configure. For more information about working with URL filters, see [URL Filters, page 17-1](#). For more information about configuring URL categories, see [Configuring URL Filters for Decryption Policy Groups, page 17-12](#).



**Note** If you want to *block* (with end-user notification) a particular URL category for HTTPS requests instead of *drop* (with no end-user notification), choose to decrypt that URL category in the Decryption Policy group and then choose to block the same URL category in the Access Policy group.

- **Web reputation.** You can configure the action to take on HTTPS requests based on the web reputation score of the requested server. Click the link under the Web Reputation column for the policy group you want to configure. For more information about working with web reputation scores, see [Web Reputation in Decryption Policies, page 19-4](#).
- **Default action.** You can configure the action the appliance should take when none of the other settings apply. Click the link under the Default Action column for the policy group you want to configure.

**Note**

The configured default action only affects the transaction when no decision is made based on URL category or Web Reputation score. If Web Reputation filtering is disabled, the default action applies to all transactions that match a Monitor action in a URL category. If Web Reputation filtering is enabled, the default action is used only if the Monitor action is selected for sites with no score.

After a Decryption Policy group is assigned to an HTTPS request, the control settings for the policy group are evaluated to determine whether to drop, pass through, or decrypt the HTTPS connection request. For more information about assigning a Decryption Policy group to an HTTPS request, see [Policy Group Membership](#), page 7-7.

Figure 11-5 on page 11-21 shows how the appliance determines which action to take on an HTTPS request after it has assigned a particular Decryption Policy to the request.

**Figure 11-5** Applying Decryption Policy Actions

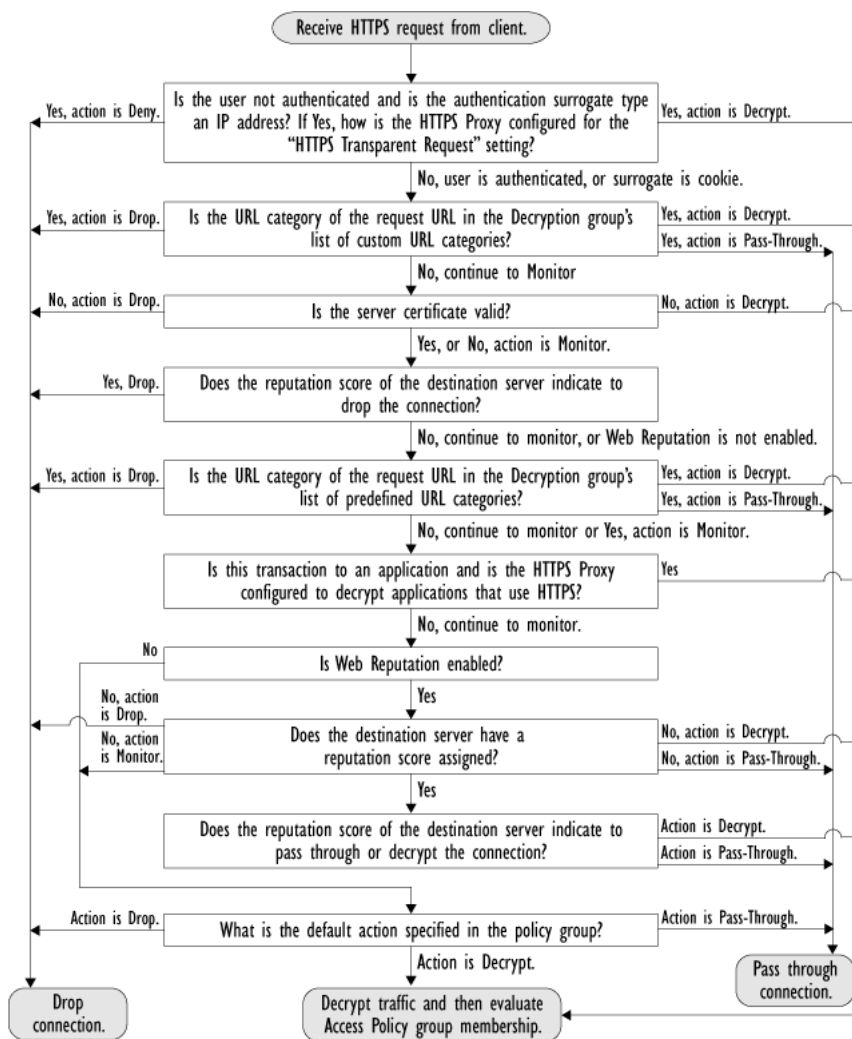

Figure 11-5 shows two different decision points that involve the web reputation score of the destination server. The web reputation score of the server is evaluated only once, but the result is applied at two different points in the decision flow.

For example, note that a web reputation score drop action overrides any action defined for predefined URL categories.

**Note**

The configured default action only affects the action on the HTTPS request when web reputation filtering is not enabled, or when it is enabled and the server has no score assigned and the action for servers with no scores is to Monitor.

## Bypassing Decryption for Particular Websites

Some HTTPS servers do not work as expected when traffic to them is decrypted by a proxy server, such as the Web Proxy. For example, some websites and their associated web applications and applets, such as high security banking sites, maintain a hard-coded list of trusted certificates instead of relying on the operating system certificate store.

You can bypass decryption for HTTPS traffic to these servers to ensure all users can access these types of sites.

- 
- Step 1** Create a custom URL category that contains the affected HTTPS servers by configuring the Advanced properties.
  - Step 2** Create a Decryption Policy that uses the custom URL category created in [Step 1](#) as part of its membership, and set the action for the custom URL category to Pass Through.

## Trusted Root Certificates

The Web Security appliance ships with and maintains a list of trusted root certificates. Web sites with trusted certificates do not require decryption.

You can manage the trusted certificate list, adding certificates to it and functionally removing certificates from it. While the Web Security appliance does not delete certificates from the master list, it allows you to override trust in a certificate, which functionally removes the certificate from the trusted list.

## Adding Certificates to the Trusted List

**Before you begin**

- Verify that the HTTPS Proxy is enabled.

- 
- Step 1** Select **Security Services > HTTPS Proxy**.
  - Step 2** Click **Manage Trusted Root Certificates**.
  - Step 3** Click **Import**.
  - Step 4** Click **Browse** and navigate to the certificate file.
  - Step 5** **Submit** and **Commit** your changes.

Look for the certificate you uploaded in the **Custom Trusted Root Certificates** list.



**Related topics**

- [Enabling the HTTPS Proxy, page 11-13](#)

## Removing Certificates from the Trusted List

---

- Step 1** Select **Security Services > HTTPS Proxy**.
- Step 2** Click **Manage Trusted Root Certificates**.
- Step 3** Select the **Override Trust** checkbox corresponding to the certificate you wish to remove from the list.
- Step 4** **Submit** and **Commit** your changes.

## Logging

HTTPS transactions in the access logs appear similar to HTTP transactions, but with slightly different characteristics. What gets logged depends on whether the transaction was explicitly sent or transparently redirected to the HTTPS Proxy:

- **TUNNEL.** This gets written to the access log when the HTTPS request was transparently redirected to the HTTPS Proxy.
- **CONNECT.** This gets written to the access log when the HTTPS request was explicitly sent to the HTTPS Proxy.

When HTTPS traffic is decrypted, the access logs contain two entries for a transaction:

- TUNNEL or CONNECT depending on the type of request processed.
- The HTTP Method and the decrypted URL. For example, “GET https://ftp.example.com”.

The full URL is only visible when the HTTPS Proxy decrypts the traffic.



# 12

## Outbound Malware Scanning

---

This chapter contains the following information:

- [Evaluating Outbound Malware Scanning Policy Group Membership](#), page 12-2
- [Creating Outbound Malware Scanning Policies](#), page 12-4
- [Controlling Upload Requests Using Outbound Malware Scanning Policies](#), page 12-6
- [Logging](#), page 12-8

### Outbound Malware Scanning Overview

Malware is pervasive and persistent, and unfortunately, usually finds access to the computers inside your network. Users increasingly work with customers and partners to collaborate on projects and increase productivity. This increased collaboration poses challenges for information security professionals to determine how to prevent malware infections on internal systems from accidentally infecting key partners, and therefore adversely affecting their reputation.

The Web Security appliance provides the outbound malware scanning feature which allows you to stop malware that is already active on computers inside the network from escaping the network and affecting customers and partners.

The Cisco IronPort Dynamic Vectoring and Streaming (DVS) engine scans transaction requests as they leave the network in real time. By working with the Cisco IronPort DVS engine, the Web Security appliance enables you to prevent users from unintentionally uploading malicious data.

To prevent malicious data from leaving the network, the Web Security appliance provides the Outbound Malware Scanning policy groups. You define which uploads are scanned for malware, which anti-malware scanning engines to use for scanning, and which malware types to block.

For more information on anti-malware scanning, see [Anti-Malware Scanning Overview](#), page 19-4.

### User Experience with Blocked Requests

When the Cisco IronPort DVS engine blocks an upload request, the Web Proxy sends a block page to the end user. However, not all websites display the block page to the end user. For example, some Web 2.0 websites display dynamic content using javascript instead of a static webpage and are not likely to display the block page. Users are still properly blocked from uploading malicious data, but they may not always be informed of this by the website.

## Outbound Malware Scanning Policy Groups

Outbound Malware Scanning Policies define whether or not the Web Proxy blocks HTTP requests and decrypted HTTPS connections for transactions that upload data to a server (upload requests). An upload request is an HTTP or decrypted HTTPS request that has content in the request body.

When the Web Proxy receives an upload request, it compares the request to the Outbound Malware Scanning policy groups to determine which policy group to apply. After it assigns the request to a policy group, it compares the request to the policy group's configured control settings to determine whether to block the request or monitor the request. When an Outbound Malware Scanning Policy determines to monitor a request, it is evaluated against the Access Policies, and the final action the Web Proxy takes on the request is determined by the applicable Access Policy.

For more information on configuring Outbound Malware Scanning Policies to block requests based on outbound malware, see [Controlling Upload Requests Using Outbound Malware Scanning Policies](#), page 12-6.

**Note**

---

Upload requests that try to upload files with a size of zero (0) bytes are not evaluated against Outbound Malware Scanning Policies.

---

## Evaluating Outbound Malware Scanning Policy Group Membership

Each client request is assigned to an Identity and is then evaluated against the other policy types to determine to which policy group it belongs for each type. The Web Proxy evaluates *upload requests* against the Outbound Malware Scanning Policies.

The Web Proxy applies the configured policy control settings to a client request based on the client request's policy group membership.

To determine the policy group that a client request matches, the Web Proxy follows a specific process for matching the group membership criteria. During this process, it considers the following factors for group membership:

- **Identity.** Each client request either matches an Identity, fails authentication and is granted guest access, or fails authentication and is terminated. For more information about evaluating Identity group membership, see [Evaluating Identity Group Membership](#), page 8-4.
- **Authorized users.** If the assigned Identity requires authentication, the user must be in the list of authorized users in the Outbound Malware Scanning Policy group to match the policy group. The list of authorized users can be any of the specified groups or users or can be guest users if the Identity allows guest access.
- **Advanced options.** You can configure several advanced options for Outbound Malware Scanning Policy group membership. Some options, such as proxy port and URL category, can also be defined within the Identity. When an advanced option is configured in the Identity, it is not configurable in the Outbound Malware Scanning Policy group level.

The information in this section gives an overview of how the Web Proxy matches upload requests to Outbound Malware Scanning Policy groups. For more details about exactly how the Web Proxy matches client requests, see [Matching Client Requests to Outbound Malware Scanning Policy Groups](#), page 12-3.

The Web Proxy reads sequentially through each policy group in the policies table. It compares the upload request status to the membership criteria of the first policy group. If they match, the Web Proxy applies the policy settings of that policy group.

If they do not match, the Web Proxy compares the upload request to the next policy group. It continues this process until it matches the upload request to a user defined policy group. If it does not match a user defined policy group, it matches the global policy group. When the Web Proxy matches the upload request to a policy group or the global policy group, it applies the policy settings of that policy group.

## Matching Client Requests to Outbound Malware Scanning Policy Groups

Figure 12-1 on page 12-3 shows how the Web Proxy evaluates an upload request against the Outbound Malware Scanning groups.

**Figure 12-1** Policy Group Flow Diagram for Outbound Malware Scanning Policies

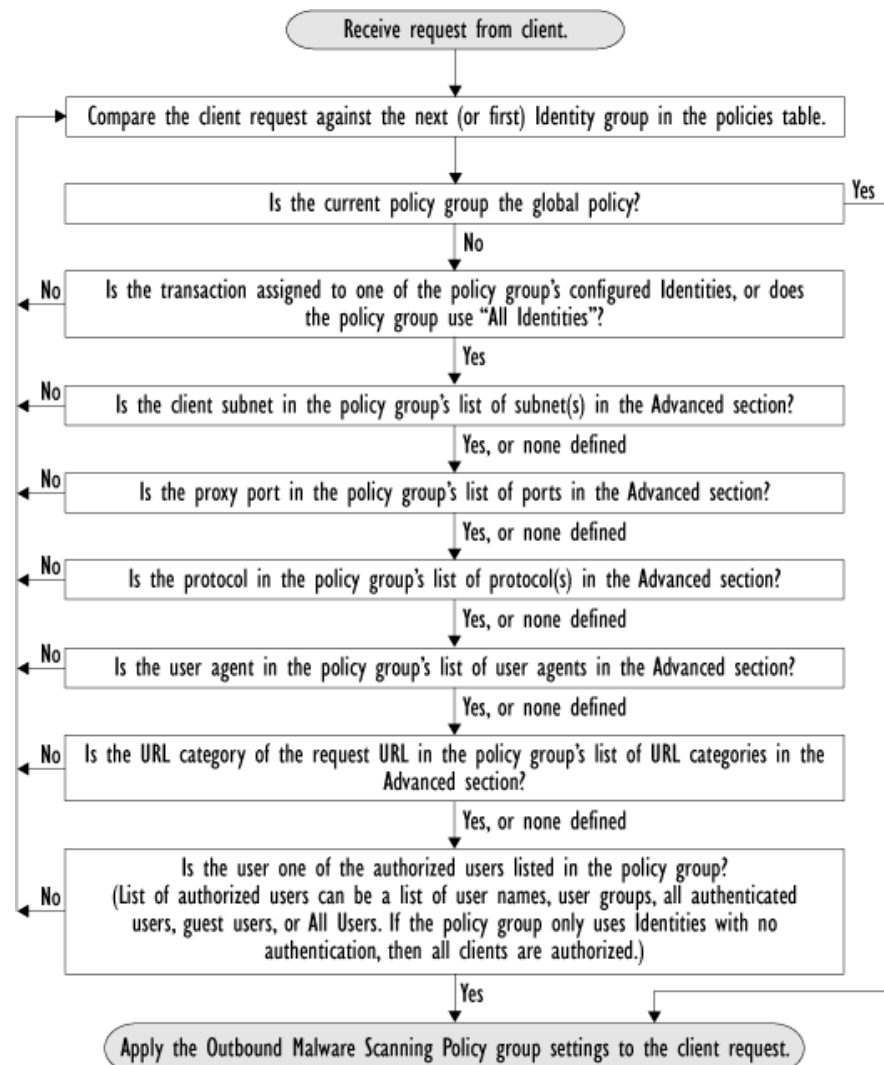

# Creating Outbound Malware Scanning Policies

You can create Outbound Malware Scanning Policy groups based on combinations of several criteria, such as one or more Identities or the URL category of the destination site. You must define at least one criterion for policy group membership. When you define multiple criteria, the upload request must meet all criteria to match the policy group. However, the upload request needs to match only one of the configured Identities.

For more information about how the Web Proxy matches an upload request with a policy group, see [Evaluating Outbound Malware Scanning Policy Group Membership, page 12-2](#) and [Matching Client Requests to Outbound Malware Scanning Policy Groups, page 12-3](#).

**Step 1** Navigate to the Web Security Manager > Outbound Malware Scanning page, and click **Add Policy**.

**Step 2** Enter a name and an optional description for the policy group.



**Note** Each policy group name must be unique and only contain alphanumeric characters or the space character.

**Step 3** In the Insert Above Policy field, select where in the policies table to place the policy group.

When configuring multiple policy groups, you must specify a logical order for each group. Carefully order your policy groups to ensure that correct matching occurs.

**Step 4** In the Identities and Users section, select one or more Identity groups to apply to this policy group.

For more information, see [Configuring Identities in Other Policy Groups, page 8-22](#).

**Step 5** Optionally, expand the Advanced section to define additional membership requirements.

▾ Advanced	Use the Advanced options to define or edit membership by protocol, proxy port, subnet, destination (URL Category), User Agents, or User Location.  The following advanced membership criteria have been defined: <ul style="list-style-type: none"> <li><b>Protocols:</b>    None Selected</li> <li><b>Proxy Ports:</b>    None Selected</li> <li><b>Subnets:</b>    None Selected</li> <li><b>URL Categories:</b>    None Selected</li> <li><b>User Agents:</b>    None Selected</li> <li><b>User Location:</b>    None Selected</li> </ul>
------------	--

**Step 6** To define policy group membership by any of the advanced options, click the link for the advanced option and configure the option on the page that appears.

Table 12-1 describes the advanced options you can configure for Outbound Malware Scanning Policy groups.

**Table 12-1** *Outbound Malware Scanning Policy Group Advanced Options*

Advanced Option	Description
Protocols	<p>Choose whether or not to define policy group membership by the protocol used in the client request. Select the protocols to include.</p> <p>“All others” means any protocol not listed above this option.</p> <p><b>Note:</b> When the HTTPS Proxy is enabled, only Decryption Policies apply to HTTPS transactions. You cannot define policy membership by the HTTPS protocol for Access, Routing, Outbound Malware Scanning, Data Security, or External DLP Policies.</p>
Proxy Ports	<p>Choose whether or not to define policy group membership by the proxy port used to access the Web Proxy. Enter one or more port numbers in the Proxy Ports field. Separate multiple ports with commas.</p> <p>For explicit forward connections, this is the port configured in the browser. For transparent connections, this is the same as the destination port. You might want to define policy group membership on the proxy port if you have one set of clients configured to explicitly forward requests on one port, and another set of clients configured to explicitly forward requests on a different port.</p> <p>Cisco recommends defining policy group membership by the proxy port only when the appliance is deployed in explicit forward mode, or when clients explicitly forward requests to the appliance. If you define policy group membership by the proxy port when client requests are transparently redirected to the appliance, some requests might be denied.</p> <p><b>Note:</b> If the Identity associated with this policy group defines Identity membership by this advanced setting, the setting is not configurable at the non-Identity policy group level.</p>
Subnets	<p>Choose whether or not to define policy group membership by subnet or other addresses.</p> <p>You can select to use the addresses that may be defined with the associated Identity, or you can enter specific addresses here.</p> <p><b>Note:</b> If the Identity associated with this policy group defines its membership by addresses, then in this policy group you must enter addresses that are a subset of the addresses defined in the Identity. Adding addresses in the policy group further narrows down the list of transactions that match this policy group.</p>
URL Categories	<p>Choose whether or not to define policy group membership by URL categories. Select the user defined or predefined URL categories.</p> <p><b>Note:</b> If the Identity associated with this policy group defines Identity membership by this advanced setting, the setting is not configurable at the non-Identity policy group level.</p>

**Table 12-1** Outbound Malware Scanning Policy Group Advanced Options (continued)

Advanced Option	Description
User Agents	<p>Choose whether or not to define policy group membership by the user agent used in the client request. You can select some commonly defined browsers, or define your own using regular expressions. Choose whether this policy group should apply to the selected user agents or to any user agent that is not in the list of selected user agents.</p> <p>For more information on creating user agent based policies, see <a href="#">Working with User Agent Based Policies, page 7-10</a>.</p> <p><b>Note:</b> If the Identity associated with this policy group defines Identity membership by this advanced setting, the setting is not configurable at the non-Identity policy group level.</p>
User Location	<p>Choose whether or not to define policy group membership by user location, either remote or local.</p> <p>This option only appears when the Secure Mobility is enabled. For more information, see <a href="#">Achieving Secure Mobility Overview, page 14-1</a>.</p>

**Step 7** Submit your changes.

**Step 8** Configure Outbound Malware Scanning Policy group control settings to define how the Web Proxy handles transactions.

The new Outbound Malware Scanning Policy group automatically inherits global policy group settings until you configure options for each control setting. For more information, see [Controlling Upload Requests Using Outbound Malware Scanning Policies, page 12-6](#).

**Step 9** Submit and commit your changes.

## Controlling Upload Requests Using Outbound Malware Scanning Policies

Each upload request is assigned to an Outbound Malware Scanning Policy group and inherits the control settings of that policy group. The control settings of the Outbound Malware Scanning Policy group determine whether or not to scan the upload request for malware and, if scanned, which malware types to block.

After the Web Proxy receives the upload request headers, it has all the information necessary to decide if it should scan the request body. The DVS engine scans the request and returns a verdict to the Web Proxy: either block or monitor (evaluate the request against the Access Policies). The block page appears to the end user, if applicable.

[Figure 12-2](#) shows where you can configure control settings for the Outbound Malware Scanning Policy groups.



**Figure 12-2** *Creating Outbound Malware Scanning Policies*

## Outbound Malware Scanning

Outbound Malware Scan Policies				
Order	Outbound Malware Scan Policies	Destinations	Anti-Malware Filtering	Delete
1	<b>exampleOMSP</b> Identity: TestLab	(global policy)	(global policy)	
	<b>Global Policy</b> Identity: All	Scan: None	Webroot: Enabled McAfee: Disabled Sophos: Enabled	

Policy Disabled

- Step 1** Navigate to the Web Security Manager > Outbound Malware Scanning page.
- Step 2** In the Destinations column, click the link for the policy group you want to configure.
- Step 3** In the Edit Destination Settings section, select “Define Destinations Scanning Custom Settings” from the drop-down menu.

**Figure 12-3** *Scanning Destinations Settings for Outbound Malware Scanning Policies*

## Outbound Malware Scan Policies: Destinations: exampleOMSPolicy

**Edit Destination Settings**

Define Destinations scanning Custom Settings ▾

**Scanning Destinations**

Destinations to Scan:

Do not scan any uploads  
 Scan all uploads  
 Scan uploads to specified custom URL categories:  
No custom URL categories have been selected  
[Edit custom categories list...](#)

- Step 4** In the Destinations to Scan section, select one of the following options:
- **Do not scan any uploads.** The DVS engine scans no upload requests. All upload requests are evaluated against the Access Policies.
  - **Scan all uploads.** The DVS engine scans all upload requests. The upload request is blocked or evaluated against the Access Policies, depending on the DVS engine scanning verdict.
  - **Scan uploads to specified custom URL categories.** The DVS engine scans upload requests that belong in specific custom URL categories. The upload request is blocked or evaluated against the Access Policies, depending on the DVS engine scanning verdict. Click **Edit custom categories list** to select the URL categories to scan.
- Step 5** Submit your changes.
- Step 6** In the Anti-Malware Filtering column, click the link for the policy group.
- Step 7** In the Anti-Malware Settings section, select “Define Anti-Malware Custom Settings” from the drop-down menu.

**Figure 12-4** Anti-Malware Settings for Outbound Malware Scanning Policies

Outbound Malware Scan Policies: Anti-Malware Settings: exampleOMSPolicy

Malware Categories	Monitor	Block
Browser Helper Object	Select all	Select all
Commercial System Monitor		✓
Dialer		✓
Encrypted File		✓
Hijacker		✓

**Step 8** In the Cisco IronPort DVS Anti-Malware Settings section, select which anti-malware scanning engines to enable for this policy group.

When you enable Sophos or McAfee scanning, you can select to monitor or block some additional categories in the Malware Categories on this page.

**Step 9** In the Malware Categories section, select whether to monitor or block the various malware categories based on a malware scanning verdict.

The categories listed in this section depend on which scanning engines you enable.



**Note** URL transactions are categorized as unscannable when the configured maximum time setting is reached or when the system experiences a transient error condition. For example, transactions might be categorized as unscannable during scanning engine updates or AsyncOS upgrades. The malware scanning verdicts SV\_TIMEOUT and SV\_ERROR are considered unscannable transactions.

**Step 10** Submit and commit your changes.

## Logging

The access logs indicate whether or not the DVS engine scanned an upload request for malware. The scanning verdict information section of each access log entry includes values for the DVS engine activity for scanned uploads. You can also add one of the fields in [Table 12-2](#) to the W3C or access logs to more easily find this DVS engine activity:

**Table 12-2** Log Fields in W3C Logs and Format Specifiers in Access Logs

W3C Log Field	Format Specifier in Access Logs
x-req-dvs-scanverdict	%X2
x-req-dvs-threat-name	%X4
x-req-dvs-verdictname	%X3

When the DVS engine marks an upload request as being malware and it is configured to block malware uploads, the ACL decision tag in the access logs is BLOCK\_AMW\_REQ.

However, when the DVS engine marks an upload request as being malware and it is configured to *monitor* malware uploads, the ACL decision tag in the access logs is actually determined by the Access Policy applied to the transaction.

To determine whether or not the DVS engine scanned an upload request for malware view the results of the DVS engine activity in the scanning verdict information section of each access log entry, or view the results of the fields from [Table 12-2](#) added to the W3C or access logs.

For more information, see [Understanding Scanning Verdict Information, page 24-21](#).



# 13

## Data Security and External DLP Policies

---

- [Data Security and External DLP Policies Overview, page 13-1](#)
- [Working with Data Security and External DLP Policies, page 13-3](#)
- [Evaluating Data Security and External DLP Policy Group Membership, page 13-4](#)
- [Creating Data Security and External DLP Policies, page 13-6](#)
- [Controlling Upload Requests Using Cisco IronPort Data Security Policies, page 13-9](#)
- [Defining External DLP Systems, page 13-13](#)
- [Controlling Upload Requests Using External DLP Policies, page 13-16](#)
- [Logging, page 13-17](#)

### Data Security and External DLP Policies Overview

In the Information Age, your organization's data is one of its most prized possessions. Your organization spends a lot of money making data available to your employees, customers, and partners. Data is always on the move by traveling over the web and email. This increased access poses challenges for information security professionals to figure out how to prevent the malicious, accidental, or unintentional loss of sensitive and proprietary information.

The Web Security appliance secures your data by providing the following capabilities:

- **Cisco IronPort Data Security Filters.** The Cisco IronPort Data Security Filters on the Web Security appliance evaluate data leaving the network over HTTP, HTTPS, and FTP to control what data goes where and how and by whom.
- **Third party data loss prevention (DLP) integration.** The Web Security appliance integrates with leading third party content-aware DLP systems that identify and protect sensitive data. The Web Proxy uses the Internet Content Adaptation Protocol (ICAP) which is a lightweight HTTP based protocol that allows proxy servers to offload content scanning to external systems. By offloading the content scanning to dedicated external systems, the Web Proxy can take advantage of the deep content scanning in other products while being free to perform other Web Proxy functions with minimal performance impact.

By working with the Cisco IronPort Data Security Filters and external DLP systems, the Web Security appliance allows you to protect information and intellectual property and enforce regulatory and organization compliance by preventing users from unintentionally uploading sensitive data. You define what kind of data is allowed to leave the network.

To restrict data that is leaving the network, the Web Security appliance provides the following types of policy groups:

- **Cisco IronPort Data Security Policies.** When you enable the Cisco IronPort Data Security Filters, you can create Cisco IronPort Data Security Policies to enforce business policies. For example, you can create a Data Security Policy that prevents users from sending out Excel or zip files. For more information, see [Data Security Policy Groups, page 13-3](#).
- **External DLP Policies.** When you configure the appliance to work with an external DLP system, you can create External DLP Policies to pass data leaving the network to the external DLP system which scans the content and determines whether or not to block the request. For more information, see [External DLP Policy Groups, page 13-4](#).

Depending on your organization's needs, you might want to use both Data Security and External DLP Policies. For example, you might use the Cisco IronPort Data Security Policies to block data uploads to websites with a low reputation score. This way, the data is never sent to the external DLP system for a deep content scan, which improves overall performance.

## Bypassing Upload Requests Below a Minimum Size

Many websites are interactive, meaning users send data as well as receive data. Users might send data when logging into a website or sending simple form data. A lot of web traffic can consist of relatively small POST requests that are harmless, but can take up many lines in the log files. This creates a lot of “noise” in the logs that can make it difficult to find and troubleshoot the true data security violations, such as users uploading company files using their personal email account.

To help reduce the number of upload requests recorded in the log files, you can define a minimum request body size, below which upload requests are not scanned by the Cisco IronPort Data Security Filters or the external DLP server.

To do this, use the following CLI commands:

- **datasecurityconfig.** Applies to the Cisco IronPort Data Security Filters.
- **externaldlpconfig.** Applies to the configured external DLP servers.

The default minimum request body size is 4 KB (4096 bytes) for both CLI commands. Valid values are 1 to 64 KB. The size you specify applies to the entire size of the upload request body.



### Note

All chunk encoded uploads and all native FTP transactions are scanned by the Cisco IronPort Data Security Filters or external DLP servers when enabled. However, they can still be bypassed based on a custom URL category. For more information, see [Figure 13-3 on page 13-11](#).

## User Experience with Blocked Requests

When the Cisco IronPort Data Security Filters or an external DLP server blocks an upload request, it provides a block page that the Web Proxy sends to the end user. However, not all websites display the block page to the end user. For example, some Web 2.0 websites display dynamic content using javascript instead of a static webpage and are not likely to display the block page. Users are still properly blocked from performing data security violations, but they may not always be informed of this by the website.

# Working with Data Security and External DLP Policies

Cisco IronPort Data Security Policies and External DLP Policies define how the Web Proxy handles HTTP requests and decrypted HTTPS connections for transactions that upload data to a server (upload requests). However, Cisco IronPort Data Security Policies use logic defined on the Web Security appliance and External DLP Policies use logic defined on the DLP system. An upload request is an HTTP or decrypted HTTPS request that has content in the request body.

When the Web Proxy receives an upload request, it compares the request to the Data Security and External DLP Policy groups to determine which policy group to apply. If both types of policies are configured, it compares the request to Cisco IronPort Data Security Policies before external DLP Policies. After it assigns the request to a policy group, it compares the request to the policy group's configured control settings to determine what to do with the request.

How you configure the appliance to handle upload requests depends on the policy group type. For more information, see [Data Security Policy Groups, page 13-3](#) and [External DLP Policy Groups, page 13-4](#).

**Note**

Upload requests that try to upload files with a size of zero (0) bytes are not evaluated against Cisco IronPort Data Security or External DLP Policies.

## Data Security Policy Groups

To configure the Web Security appliance to handle upload requests on the appliance itself, perform the following tasks:

- Step 1** **Enable the Cisco IronPort Data Security Filters.** To scan upload requests on the appliance, you must first enable the Cisco IronPort Data Security Filters. Usually, the Cisco IronPort Data Security Filters feature is enabled during the initial setup using the System Setup Wizard. Otherwise, go to the Security Services > Data Security Filters page to enable it.
- Step 2** **Create and configure Data Security Policy groups.** After the Cisco IronPort Data Security Filters feature is enabled, you create and configure Data Security Policy groups to determine how to handle upload requests from each user.

Cisco IronPort Data Security Policies use URL filtering, web reputation, and upload content information when evaluating the upload request. You configure each of these security components to determine whether or not to block the upload request. For more information about the security components that you can configure and how the Web Proxy uses Data Security Policy groups to control upload requests, see [Controlling Upload Requests Using Cisco IronPort Data Security Policies, page 13-9](#).

When the Web Proxy compares an upload request to the control settings, it evaluates the settings in order. Each control setting can be configured to perform one of the following actions for Cisco IronPort Data Security Policies:

- **Block.** The Web Proxy does not permit the connection and instead displays an end user notification page explaining the reason for the block.
- **Allow.** The Web Proxy bypasses the rest of the Data Security Policy security service scanning and then evaluates the request against the Access Policies before taking a final action.

For Cisco IronPort Data Security Policies, Allow bypasses the rest of data security scanning, but does not bypass External DLP or Access Policy scanning. The final action the Web Proxy takes on the request is determined by the applicable Access Policy (or an applicable external DLP Policy that may block the request).

- **Monitor.** The Web Proxy continues comparing the transaction to the other Data Security Policy group control settings to determine whether to block the transaction or evaluate it against the Access Policies.

For Cisco IronPort Data Security Policies, only the Block action is a final action that the Web Proxy takes on a client request. A final action is an action that causes the Web Proxy to stop comparing the transaction to all other control settings. The Monitor and Allow actions are intermediary actions. In both cases, the Web Proxy evaluates the transaction against the External DLP Policies (if configured) and Access Policies. The Web Proxy determines which final action to apply based on the Access Policy group control settings (or an applicable external DLP Policy that may block the request).

Figure 13-3 on page 13-11 shows the order that the Web Proxy uses when evaluating control settings for Cisco IronPort Data Security Policies. The flow diagram shows that the only actions applied to a transaction are the final actions: Block and evaluate against the Access Policies.

For more information on the possible Access Policy actions, see [Access Policy Groups, page 9-2](#). For more information on the Monitor action for Access Policies, see [Understanding the Monitor Action, page 9-3](#).

## External DLP Policy Groups

To configure the Web Security appliance to handle upload requests on an external DLP system, perform the following tasks:

- Step 1 Define an external DLP system.** To pass an upload request to an external DLP system for scanning, you must define at least one ICAP-compliant DLP system on the Web Security appliance. Do this on the Network > External DLP Servers page. For more information, see [Defining External DLP Systems, page 13-13](#).
- Step 2 Create and configure External DLP Policy groups.** After an external DLP system is defined, you create and configure External DLP Policy groups to determine which upload requests to send to the DLP system for scanning.

When an upload request matches an External DLP Policy, the Web Proxy sends the upload request to the DLP system using the Internet Content Adaptation Protocol (ICAP) for scanning. The DLP system scans the request body content and returns a block or allow verdict to the Web Proxy. The allow verdict is similar to the Allow action for Cisco IronPort Data Security Policies in that the upload request will be compared to the Access Policies. The final action the Web Proxy takes on the request is determined by the applicable Access Policy.

For more information about configuring External DLP Policy groups, see [Controlling Upload Requests Using External DLP Policies, page 13-16](#).

## Evaluating Data Security and External DLP Policy Group Membership

Each client request is assigned to an Identity and then is evaluated against the other policy types to determine which policy group it belongs for each type. The Web Proxy evaluates *upload requests* against the Data Security and External DLP Policies.



The Web Proxy applies the configured policy control settings to a client request based on the client request's policy group membership.

To determine the policy group that a client request matches, the Web Proxy follows a specific process for matching the group membership criteria. During this process, it considers the following factors for group membership:

- **Identity.** Each client request either matches an Identity, fails authentication and is granted guest access, or fails authentication and gets terminated. For more information about evaluating Identity group membership, see [Evaluating Identity Group Membership, page 8-4](#).
- **Authorized users.** If the assigned Identity requires authentication, the user must be in the list of authorized users in the Data Security or External DLP Policy group to match the policy group. The list of authorized users can be any of the specified groups or users or can be guest users if the Identity allows guest access.
- **Advanced options.** You can configure several advanced options for Data Security and External DLP Policy group membership. Some options (such as proxy port and URL category) can also be defined within the Identity. When an advanced option is configured in the Identity, it is not configurable in the Data Security or External DLP Policy group level.

The information in this section gives an overview of how the Web Proxy matches upload requests to both Data Security and External DLP Policy groups. For more details about exactly how the Web Proxy matches client requests, see [Matching Client Requests to Data Security and External DLP Policy Groups, page 13-5](#).

The Web Proxy sequentially reads through each policy group in the policies table. It compares the upload request status to the membership criteria of the first policy group. If they match, the Web Proxy applies the policy settings of that policy group.

If they do not match, the Web Proxy compares the upload request to the next policy group. It continues this process until it matches the upload request to a user defined policy group. If it does not match a user defined policy group, it matches the global policy group. When the Web Proxy matches the upload request to a policy group or the global policy group, it applies the policy settings of that policy group.

## Matching Client Requests to Data Security and External DLP Policy Groups

[Figure 13-1 on page 13-6](#) shows how the Web Proxy evaluates an upload request against the Data Security and External DLP Policy groups.

Figure 13-1 Policy Group Flow Diagram for Data Security and External DLP Policies

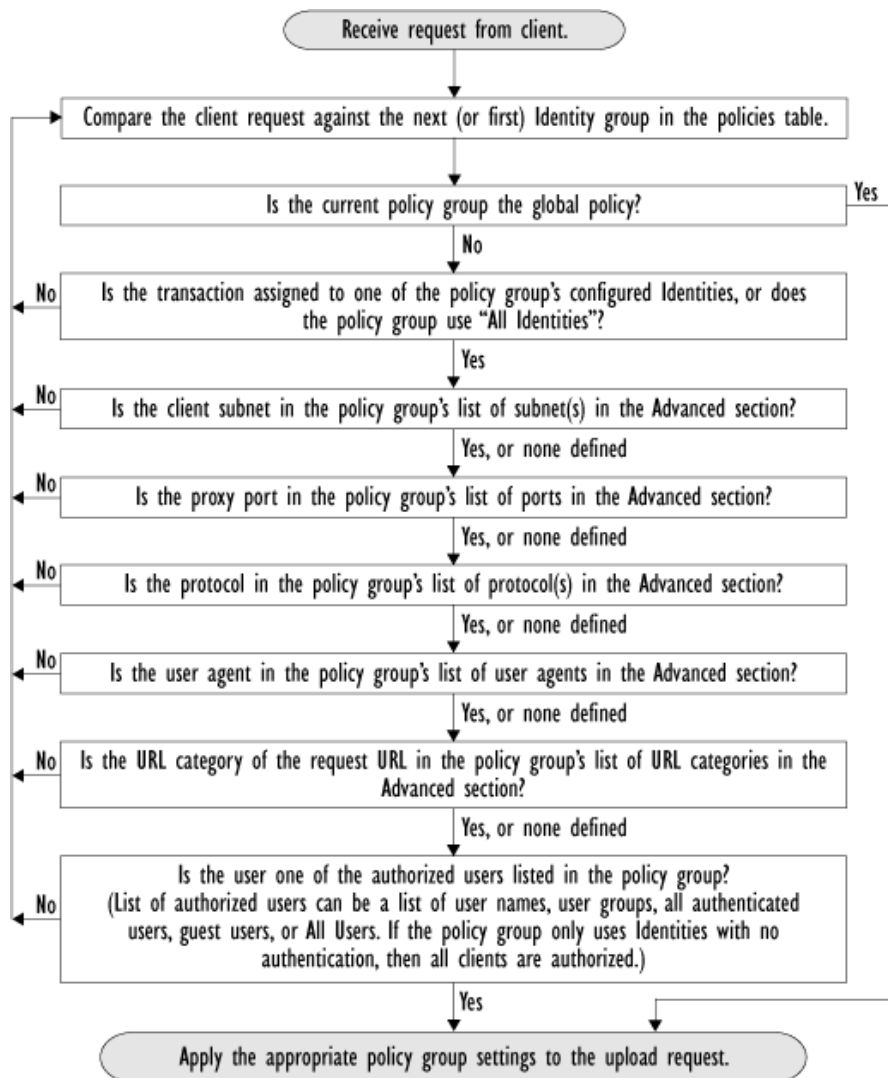

## Creating Data Security and External DLP Policies

You can create Data Security and External DLP Policy groups based on combinations of several criteria, such as one or more Identities or the URL category of the destination site. You must define at least one criterion for policy group membership. When you define multiple criteria, the upload request must meet all criteria to match the policy group. However, the upload request needs to match only one of the configured Identities.

For more information about how the Web Proxy matches an upload request with a policy group, see [Evaluating Data Security and External DLP Policy Group Membership](#), page 13-4 and [Matching Client Requests to Data Security and External DLP Policy Groups](#), page 13-5.

Define Data Security Policy group membership on the Web Security Manager > Cisco IronPort Data Security page. Define External DLP Policy group membership on the Web Security Manager > External Data Loss Prevention page.

- Step 1** Navigate to the Web Security Manager > Cisco IronPort Data Security page or the Web Security Manager > External Data Loss Prevention page.
- Step 2** Click **Add Policy**.
- Step 3** In the Policy Name field, enter a name for the policy group, and in the Description field, optionally add a description.



**Note** Each policy group name must be unique and only contain alphanumeric characters or the space character.

- Step 4** In the Insert Above Policy field, choose where in the policies table to place the policy group. When configuring multiple policy groups you must specify a logical order for each group. Carefully order your policy groups to ensure that correct matching occurs.
- Step 5** In the Identities and Users section, choose one or more Identity groups to apply to this policy group. For more information on how to do this, see [Configuring Identities in Other Policy Groups, page 8-22](#).
- Step 6** Optionally, expand the Advanced section to define additional membership requirements.

▼ Advanced	Use the Advanced options to define or edit membership by protocol, proxy port, subnet, destination (URL Category), User Agents, or User Location. The following advanced membership criteria have been defined: <ul style="list-style-type: none"> <li><b>Protocols:</b>    None Selected</li> <li><b>Proxy Ports:</b>    None Selected</li> <li><b>Subnets:</b>    None Selected</li> <li><b>URL Categories:</b>    None Selected</li> <li><b>User Agents:</b>    None Selected</li> <li><b>User Location:</b>    None Selected</li> </ul>
------------	--

- Step 7** To define policy group membership by any of the advanced options, click the link for the advanced option and configure the option on the page that appears.

Table 13-1 describes the advanced options you can configure for Data Security and External DLP Policy groups.

**Table 13-1 Data Security and External DLP Policy Group Advanced Options**

Advanced Option	Description
Protocols	<p>Choose whether or not to define policy group membership by the protocol used in the client request. Select the protocols to include.</p> <p>“All others” means any protocol not listed above this option.</p> <p><b>Note:</b> When the HTTPS Proxy is enabled, only Decryption Policies apply to HTTPS transactions. You cannot define policy membership by the HTTPS protocol for Access, Routing, Outbound Malware Scanning, Data Security, or External DLP Policies.</p>
Proxy Ports	<p>Choose whether or not to define policy group membership by the proxy port used to access the Web Proxy. Enter one or more port numbers in the Proxy Ports field. Separate multiple ports with commas.</p> <p>For explicit forward connections, this is the port configured in the browser. For transparent connections, this is the same as the destination port. You might want to define policy group membership on the proxy port if you have one set of clients configured to explicitly forward requests on one port, and another set of clients configured to explicitly forward requests on a different port.</p> <p>Cisco recommends only defining policy group membership by the proxy port when the appliance is deployed in explicit forward mode, or when clients explicitly forward requests to the appliance. If you define policy group membership by the proxy port when client requests are transparently redirected to the appliance, some requests might be denied.</p> <p><b>Note:</b> If the Identity associated with this policy group defines Identity membership by this advanced setting, the setting is not configurable at the non-Identity policy group level.</p>
Subnets	<p>Choose whether or not to define policy group membership by subnet or other addresses.</p> <p>You can choose to use the addresses that may be defined with the associated Identity, or you can enter specific addresses here.</p> <p><b>Note:</b> If the Identity associated with this policy group defines its membership by addresses, then in this policy group you must enter addresses that are a subset of the addresses defined in the Identity. Adding addresses in the policy group further narrows down the list of transactions that match this policy group.</p>
URL Categories	<p>Choose whether or not to define policy group membership by URL categories. Select the user defined or predefined URL categories.</p> <p><b>Note:</b> If the Identity associated with this policy group defines Identity membership by this advanced setting, the setting is not configurable at the non-Identity policy group level.</p>

**Table 13-1** Data Security and External DLP Policy Group Advanced Options (continued)

Advanced Option	Description
User Agents	<p>Choose whether or not to define policy group membership by the user agent used in the client request. You can select some commonly defined browsers, or define your own using regular expressions. Choose whether this policy group should apply to the selected user agents or to any user agent that is not in the list of selected user agents.</p> <p>For more information on creating user agent based policies, see <a href="#">Working with User Agent Based Policies, page 7-10</a>.</p> <p><b>Note:</b> If the Identity associated with this policy group defines Identity membership by this advanced setting, the setting is not configurable at the non-Identity policy group level.</p>
User Location	<p>Choose whether or not to define policy group membership by user location, either remote or local.</p> <p>This option only appears when the Secure Mobility is enabled. For more information, see <a href="#">Achieving Secure Mobility Overview, page 14-1</a>.</p>

**Step 8** Submit your changes.

**Step 9** If you are creating a Data Security Policy group, configure its control settings to define how the Web Proxy handles upload requests.

The new Data Security Policy group automatically inherits global policy group settings until you configure options for each control setting. For more information, see [Controlling Upload Requests Using Cisco IronPort Data Security Policies, page 13-9](#).

**Step 10** If you are creating an External DLP Policy group, configure its control settings to define how the Web Proxy handles upload requests.

The new External DLP Policy group automatically inherits global policy group settings until you configure custom settings. For more information, see [Controlling Upload Requests Using External DLP Policies, page 13-16](#).

**Step 11** Submit and commit your changes.

## Controlling Upload Requests Using Cisco IronPort Data Security Policies

Each upload request is assigned to a Data Security Policy group and inherits the control settings of that policy group. The control settings of the Data Security Policy group determine whether the appliance blocks the connection or evaluates it against the Access Polices.

Configure control settings for Data Security Policy groups on the Web Security Manager > Cisco IronPort Data Security page.

[Figure 13-2](#) shows where you can configure control settings for the Data Security Policy groups.

**Figure 13-2** Creating Secure Cisco IronPort Data Security Policies

## IronPort Data Security

IronPort Data Security Policies					
Add Policy...					
Order	IronPort Data Security Policy	URL Categories	Web Reputation	Content	Delete
1	<b>exampleIDSP</b> Identity: TestLab	(global policy)	(global policy)	(global policy)	
	<b>Global Policy</b> Identity: All	Monitor: 66	Enabled	No maximum size for HTTP/HTTPS No maximum size for FTP	

Policy Disabled

You can configure the following settings to determine what action to take on upload requests:

- **URL Categories.** For more information, see [URL Categories, page 13-11](#).
- **Web Reputation.** For more information, see [Web Reputation, page 13-12](#).
- **Content.** For more information, see [Content Blocking, page 13-12](#).

After a Data Security Policy group is assigned to an upload request, the control settings for the policy group are evaluated to determine whether to block the request or evaluate it against the Access Policies. For more information about assigning a Data Security Policy group to an upload request, see [Policy Group Membership, page 7-7](#).

[Figure 13-3 on page 13-11](#) shows how the appliance determines which action to take on an upload request after it has assigned a particular Data Security Policy to the request.

Figure 13-3 Applying Data Security Policy Actions

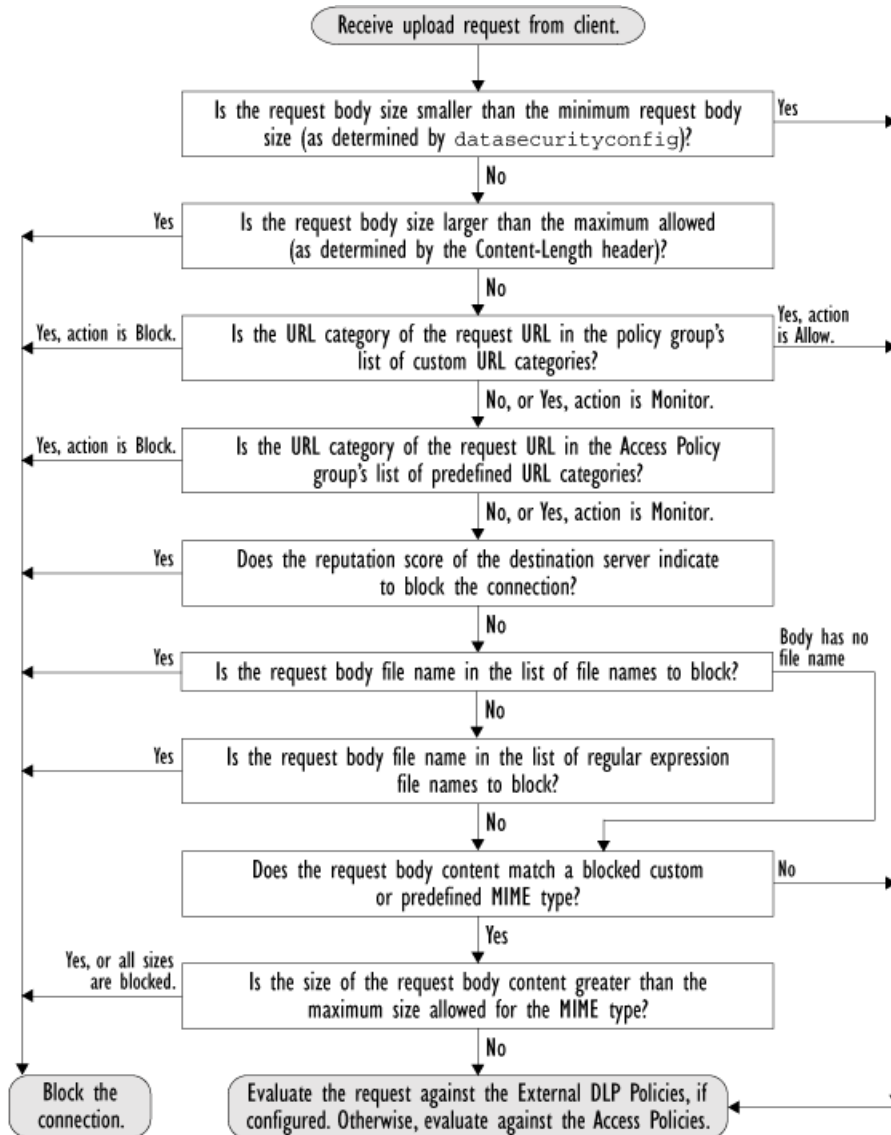

## URL Categories

AsyncOS for Web allows you to configure how the appliance handles a transaction based on the URL category of a particular request. Using a predefined category list, you can choose to monitor or block content by category. You can also create custom URL categories and choose to allow, monitor, or block traffic for a website in the custom category.

For more information about working with URL categories, see [Configuring URL Filters for Data Security Policy Groups](#), page 17-13.

## Web Reputation

The Web Reputation setting inherits the global setting. To customize web reputation filtering for a particular policy group, you can use the Web Reputation Settings pull-down menu to customize web reputation score thresholds.

Only negative and zero values can be configured for web reputation threshold settings for Cisco IronPort Data Security Policies. By definition, all positive scores are monitored.

For more information about configuring web reputation scores, see [Web Reputation in Cisco IronPort Data Security Policies, page 19-4](#).

## Content Blocking

You can use the settings on the Cisco IronPort Data Security Policies > Content page to configure the Web Proxy to block data uploads based on the following file characteristics:

- **File size.** You can specify the maximum *upload* size allowed. All uploads with sizes equal to or greater than the specified maximum are blocked. You can specify different maximum file sizes for HTTP/HTTPS and native FTP requests.

When the upload request size is greater than both the maximum upload size and the maximum scan size (configured in the “Object Scanning Limits” field on Security Services > Anti-Malware page), the upload request is still blocked, but the entry in the data security logs does not record the file name and content type. The entry in the access logs is unchanged.

- **File type.** You can block predefined file types or custom MIME types you enter. When you block a predefined file type, you can block all files of that type or files greater than a specified size. When you block a file type by size, the maximum file size you can specify is the same as the value for the “Object Scanning Limits” field on Security Services > Anti-Malware page. By default, that value is 32 MB.

Cisco IronPort Data Security Filters do not inspect the contents of archived files when blocking by file type. Archived files can be blocked by its file type or file name, not according to its contents.



---

**Note** For some groups of MIME types, blocking one type blocks all MIME types in the group. For example, blocking application/x-java-applet blocks all java MIME types, such as application/java and application/javascript.

---

- **File name.** You can block files with specified names. You can use text as a literal string or a regular expression for specifying file names to block. For more information on using regular expressions, see [Regular Expressions, page 17-23](#).



---

**Note** Only enter file names with 8-bit ASCII characters. The Web Proxy only matches file names with 8-bit ASCII characters.

---

[Figure 13-4 on page 13-13](#) shows the Cisco IronPort Data Security Policies > Content page where you configure the content control settings.



**Figure 13-4 Cisco IronPort Data Security Policies Content Settings**

IronPort Data Security Policies: Content: exampleIDSP

Edit Content Settings	
Define Custom Objects Blocking Settings	
File Size	
HTTP/HTTPS Maximum File Size:	<input type="text" value="0"/> MB <input checked="" type="radio"/> No Maximum
FTP Maximum File Size:	<input type="text" value="0"/> MB <input checked="" type="radio"/> No Maximum
Block File Types	
<a href="#">File and MIME Type Reference</a>	
<ul style="list-style-type: none"> <li>▸ Archives</li> <li>▸ Document Types</li> <li>▾ Executable Code <ul style="list-style-type: none"> <li><input type="checkbox"/> ActiveX Plugin <input type="text" value="Block all files of this type"/> KB</li> <li><input type="checkbox"/> Windows Executable <input type="text" value="Block all files of this type"/> KB</li> <li><input type="checkbox"/> Java Program <input type="text" value="Block all files of this type"/> KB</li> <li><input type="checkbox"/> UNIX Executable <input type="text" value="Block all files of this type"/> KB</li> <li><input type="checkbox"/> Mozilla/Firefox Extension <input type="text" value="Block all files of this type"/> KB</li> </ul> </li> <li>▸ Installers</li> <li>▸ Media</li> <li>▸ P2P Metafiles</li> <li>▸ Web Page Content</li> <li>▸ Miscellaneous</li> </ul>	
Custom MIME Types	
<a href="#">File and MIME Type Reference</a>	
Custom MIME Types:	<div style="border: 1px solid black; height: 60px;"></div>
<small>(Enter multiple entries on separate lines. Example: audio/x-mpeg3 or audio/* are valid entries.)</small>	
File Names	
File Names to Block:	<div style="border: 1px solid black; height: 60px;"></div>
<small>(Enter multiple entries on separate lines. Example: document.doc or spreadsheet.xls are valid entries. File names are not case sensitive.)</small>	
<small>▸ Advanced Match specific file names by regular expressions.</small>	

## Defining External DLP Systems

The Web Security appliance can integrate with multiple external DLP servers from the same vendor by defining multiple DLP servers in the appliance. Define DLP systems and global settings that affect integration with all DLP systems on the Network > External DLP Servers page.

**Figure 13-5** Network > External DLP Servers Page

## External DLP Servers

External Data Loss Prevention Servers	
External DLP Servers:	dlp.example.com: 1344, icap://dlp.example.com
Load Balancing:	Fewest Connections
Service Request Timeout:	60 seconds
Maximum Connections Per Server:	25
Failure Handling:	Permit all data transfers to proceed without scanning
<a href="#">Edit Settings...</a>	

You can define the load balancing technique the Web Proxy uses when contacting the DLP systems. This is useful when you define multiple DLP systems. For example, the Web Proxy can contact each DLP system using round-robin or a hash function.

**Note**

Verify the external DLP server does not send the Web Proxy modified content. AsyncOS for Web only supports the ability to block or allow upload requests. It does not support uploading content modified by an external DLP server.

## Configuring External DLP Servers

- Step 1** Navigate to the Network > External DLP Servers page.
- Step 2** Click **Edit Settings**.

**Figure 13-6** Configuring External DLP Servers

## Edit External DLP Servers

External Data Loss Prevention Servers										
External DLP Servers:	<table border="1"> <thead> <tr> <th>Server</th> <th>Port</th> <th>Reconnection Attempts</th> </tr> </thead> <tbody> <tr> <td>dlp.example.com</td> <td>1344</td> <td>3</td> </tr> <tr> <td colspan="3">           Service URL            icap://dlp.example.com  <small>An ICAP URL must begin with icap:// and may not contain any whitespace. Consult your DLP appliance vendor documentation for correct service URL for your system.</small> </td> </tr> </tbody> </table> <div style="text-align: right;"><a href="#">Add Row</a></div>	Server	Port	Reconnection Attempts	dlp.example.com	1344	3	Service URL icap://dlp.example.com <small>An ICAP URL must begin with icap:// and may not contain any whitespace. Consult your DLP appliance vendor documentation for correct service URL for your system.</small>		
Server	Port	Reconnection Attempts								
dlp.example.com	1344	3								
Service URL icap://dlp.example.com <small>An ICAP URL must begin with icap:// and may not contain any whitespace. Consult your DLP appliance vendor documentation for correct service URL for your system.</small>										
	<a href="#">Start Test</a>									
Load Balancing:	Fewest Connections									
Service Request Timeout:	60 seconds									
Maximum Simultaneous Connections:	25									
Failure Handling:	<input checked="" type="radio"/> Permit all data transfers to proceed without scanning <input type="radio"/> Block data transfer for transactions where scanning was requested									

**Step 3** Enter the information in [Table 13-2](#).

**Table 13-2 External DLP Server Settings**

Setting	Description
External DLP Servers	<p>Enter the following information to access an ICAP compliant DLP system:</p> <ul style="list-style-type: none"> <li>• <b>Server address and port.</b> The hostname or IP address and TCP port for accessing the DLP system.</li> <li>• <b>Reconnection attempts.</b> The number of times the Web Proxy tries to connect to the DLP system before failing.</li> <li>• <b>DLP Service URL.</b> The ICAP query URL specific to the particular DLP server. The Web Proxy includes what you enter here in the ICAP request it sends to the external DLP server. The URL must start with the ICAP protocol: <code>icap://</code></li> </ul>
Load Balancing	<p>If multiple DLP servers are defined, select which load balancing technique the Web Proxy uses to distribute upload requests to different DLP servers. You can choose the following load balancing techniques:</p> <ul style="list-style-type: none"> <li>• <b>None (failover).</b> The Web Proxy directs upload requests to one DLP server. It tries to connect to the DLP servers in the order they are listed. If one DLP server cannot be reached, the Web Proxy attempts to connect to the next one in the list.</li> <li>• <b>Fewest connections.</b> The Web Proxy keeps track of how many active requests are with the different DLP servers and it directs the upload request to the DLP server currently servicing the fewest number of connections.</li> <li>• <b>Hash based.</b> The Web Proxy uses a hash function to distribute requests to the DLP servers. The hash function uses the proxy ID and URL as inputs so that requests for the same URL are always directed to the same DLP server.</li> <li>• <b>Round robin.</b> The Web Proxy cycles upload requests equally among all DLP servers in the listed order.</li> </ul>
Service Request Timeout	<p>Enter how long the Web Proxy waits for a response from the DLP server. When this time is exceeded, the ICAP request has failed and the upload request is either blocked or allowed, depending on the Failure Handling setting.</p> <p>Default is 60 seconds.</p>
Maximum Simultaneous Connections	<p>Specifies the maximum number of simultaneous ICAP request connections from the Web Security appliance to each configured external DLP server. The Failure Handling setting on this page applies to any request which exceeds this limit.</p> <p>Default is 25.</p>
Failure Handling	<p>Choose whether upload requests are blocked or allowed (passed to Access Policies for evaluation) when the DLP server fails to provide a timely response.</p> <p>Default is allow (“Permit all data transfers to proceed without scanning”).</p>

**Step 4** Optionally, you can add another DLP server by clicking Add Row and entering the DLP Server information in the new fields provided.

- Step 5** You can test the connection between the Web Security appliance and the defined external DLP server(s) by clicking **Start Test**.
- Step 6** Submit and commit your changes.

## Controlling Upload Requests Using External DLP Policies

Each upload request is assigned to an External DLP Policy group and inherits the control settings of that policy group. The control settings of the External DLP Policy group determine whether or not to send the upload request to the external DLP system for scanning.

Once the Web Proxy receives the upload request headers, it has all the information necessary to decide if the request should go to the external DLP system for scanning. The DLP system scans the request and returns a verdict to the Web Proxy, either block or monitor (evaluate the request against the Access Policies). The block page provided by the DLP system appears to the end user, if applicable.



### Note

If any Data Security Policy group applies to the upload request, the Web Proxy evaluates the policy group's control settings against the upload request at the same time the external DLP system scans the request. If a Data Security Policy setting blocks the request before the DLP system is done scanning, the Web Proxy blocks the request and terminates the ICAP session with the DLP system.

Configure control settings for External DLP Policy groups on the Web Security Manager > External Data Loss Prevention page.

Figure 13-7 shows where you can configure control settings for the External DLP Policy groups.

**Figure 13-7** Creating External DLP Policies

### External Data Loss Prevention

External DLP Policies			
<a href="#">Add Policy...</a>			
Order	External DLP Policy	Destinations	Delete
1	<b>exampleDLP</b> Identity: TestLab	(global policy)	
	<b>Global Policy</b> Identity: All	Scan: None	

Policy Disabled

- Step 1** Navigate to the Web Security Manager > External Data Loss Prevention page.
- Step 2** Click the link under the Destinations column for the policy group you want to configure.
- Step 3** Under the Edit Destination Settings section, choose “Define Destinations Scanning Custom Settings” from the drop down menu if it is not selected already.

**Figure 13-8 Scanning Destinations Settings for External DLP Policies**

External DLP Policies: Destinations: exampleExternalDLPPolicy

**Step 4** In the Destination to scan section, choose one of the following options:

- **Do not scan any uploads.** No upload requests are sent to the configured DLP system(s) for scanning. All upload requests are evaluated against the Access Policies.
- **Scan all uploads.** All upload requests are sent to the configured DLP system(s) for scanning. The upload request is blocked or evaluated against the Access Policies depending on the DLP system scanning verdict.
- **Scan uploads to specified custom URL categories only.** Upload requests that fall in specific custom URL categories are sent to the configured DLP system for scanning. The upload request is blocked or evaluated against the Access Policies depending on the DLP system scanning verdict. Click **Edit custom categories list** to select the URL categories to scan.

**Step 5** Submit and commit your changes.

## Logging

The access logs indicate whether or not an upload request was scanned by either the Cisco IronPort Data Security Filters or an external DLP server. The access log entries include a field for the Cisco IronPort Data Security scan verdict and another field for the External DLP scan verdict based. For more information, see [Understanding Scanning Verdict Information, page 24-21](#).

In addition to the access logs, the Web Security appliance provides the following log file types to troubleshoot Cisco IronPort Data Security and External DLP Policies:

- **Data Security Logs.** Records client history for upload requests that are evaluated by the Cisco IronPort Data Security Filters.
- **Data Security Module Logs.** Records messages related to the Cisco IronPort Data Security Filters.
- **Default Proxy Logs.** In addition recording errors related to the Web Proxy, the default proxy logs include messages related to connecting to external DLP servers. This allows you to troubleshoot connectivity or integration problems with external DLP servers.

The following text illustrates a sample Data Security Log entry:

```
Mon Mar 30 03:02:13 2009 Info: 303 10.1.1.1 - -
<<bar, text/plain, 5120><foo, text/plain, 5120>>
BLOCK_WEBECAT_IDS-allowall-DefaultGroup-DefaultGroup-NONE-DefaultRouting ns server.com nc
```

Table 13-3 describes the Data Security Log fields.

**Table 13-3 Data Security Log Fields**

Field Value	Description
Mon Mar 30 03:02:13 2009 Info:	Timestamp and trace level
303	Transaction ID
10.1.1.1	Source IP address
-	User name
-	Authorized group names
<<bar,text/plain,5120><foo,text/plain,5120>>	File name, file type, file size for each file uploaded at once <b>Note:</b> This field does not include text/plain files that are less than the configured minimum request body size, the default of which is 4096 bytes. For more information on configuring the minimum request body size, see <a href="#">Bypassing Upload Requests Below a Minimum Size, page 13-2</a> .
BLOCK_WEBECAT_IDS-allowall-DefaultGroup-DefaultGroup-NONE-DefaultRouting	Cisco IronPort Data Security Policy and action
ns	Web reputation score
server.com	Outgoing URL
nc	URL category



**Note**

To learn when data transfer, such as a POST request, to a site was blocked by the external DLP server, search for the IP address or hostname of the DLP server in the access logs.

# 14

## Achieving Secure Mobility

---

- [Achieving Secure Mobility Overview, page 14-1](#)
- [Working with Remote Users, page 14-2](#)
- [Enabling Secure Mobility, page 14-2](#)
- [Transparently Identifying Remote Users, page 14-3](#)
- [Logging, page 14-4](#)
- [Configuring Secure Mobility Using the CLI, page 14-4](#)

### Achieving Secure Mobility Overview

Today, users and their devices are increasingly more mobile, connecting to the Internet from several locations, such as the office, home, airports, or cafes. Traditionally, users inside the network are protected from security threats, and users outside the traditional network boundary have no acceptable use policy enforcement, minimal protection against malware, and a high risk of data loss.

Employers want to create flexible working environments where employees and partners can work anywhere on any device, but they also want to protect corporate interests and assets from Internet-based threats at all times (always-on security).

Traditional network and content security solutions are great for protecting users and assets behind the network firewall, but are useless when users or devices are not connected to the network, or when data is not routed through the security solutions.

Cisco offers Cisco AnyConnect Secure Mobility to extend the network perimeter to remote endpoints, enabling the seamless integration of web filtering services offered by the Web Security appliance. Secure Mobility is a collection of features across multiple Cisco products that restores security and control in borderless networks. The Cisco products that work with Secure Mobility are the Cisco IronPort Web Security appliance, Cisco ASA 5500 series adaptive security appliance, and Cisco AnyConnect secure mobility client.

Using Secure Mobility, mobile and remote users have a seamless experience and are always protected from risks as if they were local users connected within the network.

When Secure Mobility is enabled on the Web Security appliance, you can distinguish remote users from local users. This allows you to perform the following tasks:

- Create Identities and other policies for remote users.
- View reports for remote traffic.
- Enable single sign-on (SSO) for remote users.

For information on enabling single sign-on, see [Transparently Identifying Remote Users, page 14-3](#).

## Working with Remote Users

When Secure Mobility is enabled, you can configure Identities and other policies to apply to users by their location:

- **Remote users.** These users are connected to the network from a remote location using VPN (virtual private network). Users might be located in a home office, coffee shop, or hotel, for example. The Web Security appliance automatically identifies remote users when both the Cisco adaptive security appliance and Cisco AnyConnect client are used for VPN access. Otherwise, the Web Security appliance administrator must specify remote users by configuring a range of IP addresses.
- **Local users.** These users are connected to the network either physically or wirelessly.

You might want to create separate policies for remote and local users. For example, you can create Access Policies that allow access to Arts and Entertainment sites when users are outside the office (remote users), but block access when users are in the office (local users).

When you enable Secure Mobility on the Security Services > AnyConnect Secure Mobility Page, you identify remote users using one of the following methods:

- **Associate by IP address.** Specify a range of IP addresses that the appliance should consider as assigned to remote devices. Typically, the Cisco adaptive security appliance assigns these IP addresses to devices that connect using VPN functionality. When the Web Security appliance receives a transaction from one of the configured IP addresses, it considers the user as a remote user.
- **Integrate with a Cisco ASA.** Specify one or more Cisco adaptive security appliances the Web Security appliance communicates with. The Cisco adaptive security appliance maintains an IP address-to-user mapping and communicates that information with the Web Security appliance. When the Web Proxy receives a transaction, it obtains the IP address and determines the user by checking the IP address-to-user mapping. When users are determined by integrating with a Cisco adaptive security appliance, you can enable single sign-on for remote users.

For information on enabling single sign-on, see [Transparently Identifying Remote Users, page 14-3](#).

## Enabling Secure Mobility

To protect remote users using always-on security, first you must enable the Secure Mobility feature on the Web Security appliance. When Secure Mobility is enabled, you can distinguish between remote users from local users when creating Identities.



### Note

You can also configure Secure Mobility using the CLI. For more information, see [Configuring Secure Mobility Using the CLI, page 14-4](#).

- 
- Step 1** Navigate to the Security Services > AnyConnect Secure Mobility page, and click **Enable**.
  - Step 2** Read the terms of the AnyConnect Secure Mobility License Agreement, and click **Accept**.
  - Step 3** Verify the Enable AnyConnect Secure Mobility field is enabled.

Configure how to identify remote users, by IP address or by integrating with one or more Cisco adaptive security appliances. For more information, see [Working with Remote Users, page 14-2](#).

- Step 4** To identify remote users by IP address, select the IP Range option, enter a range of IP addresses in the IP Range field, and then go to step 10. Otherwise, go to step 5.



- Step 5** To identify remote users by integrating with one or more Cisco adaptive security appliances, select the Cisco ASA Integration option.
- Step 6** Configure at least one Cisco adaptive security appliance by entering the Cisco adaptive security appliance host name or IP address in the ASA Host Name or IP Address field, and the port number used to access the ASA in the Port field. The default port number for the Cisco ASA is 11999.
- Step 7** If multiple Cisco adaptive security appliances are configured in a cluster, click **Add Row** and configure each ASA in the cluster. If two Cisco adaptive security appliances are configured for high availability, enter only one host name or IP address for the *active* Cisco adaptive security appliance.
- Step 8** In the ASA Access Password field, enter the access password for the Cisco adaptive security appliances specified in steps 6 and 7. The access password must be at least eight characters, and no more than 20 characters. The allowed characters are:
- 0-9 a-z A-Z . , : ; \_ / -
-  **Note** The password you enter here must match the access password configured for the specified Cisco adaptive security appliances.
- Step 9** Optionally, click **Start Test** to verify the Web Security appliance can connect to the configured Cisco adaptive security appliances.
- Step 10** Submit and commit your changes.

## Transparently Identifying Remote Users

When the Web Security appliance integrates with a Cisco adaptive security appliance, you can configure it to identify users by an authenticated user name transparently—that is, without prompting the end user. You might want to do this to achieve single sign-on for remote users.



**Note** You can also identify users transparently using Novell eDirectory and Active Directory. For more information, see [Identifying Users Transparently, page 8-12](#).

- Step 1** Enable Secure Mobility on the Security Services > AnyConnect Secure Mobility page. For more information, see [Enabling Secure Mobility, page 14-2](#).
- Step 2** Create an Identity group that applies to remote users:
- In the “Define Members by User Location” section, select Remote Users Only.
  - In the “Define Members by Authentication” section, select “Identify Users Transparently through Cisco ASA Integration.”
  - Configure all other Identity options as desired.
- For more information on creating Identities, see [Creating Identities, page 8-18](#).
- Step 3** Create policies that use the Identity for remote users.

# Logging

The access logs indicate whether each transaction was made by a local or remote user. You can also add the same custom format specifier (%1) to the existing access logs, or you can add the equivalent W3C field (auth-user-type) to the W3C access logs.

In addition to the access logs, the Web Security appliance provides the following logs for troubleshooting potential Secure Mobility issues.

- **User Discovery Service (UDS) log.** The UDS log records data about how the Web Proxy discovers the user name without doing actual authentication. It includes information about interacting with the Cisco adaptive security appliance for Secure Mobility as well as integrating with the Novell eDirectory server for transparent user identification.
- **AnyConnect Secure Mobility Daemon log.** The AnyConnect Secure Mobility Daemon log records the interaction between the Web Security appliance and the AnyConnect client, including the status check.

## Configuring Secure Mobility Using the CLI

Table 14-1 describes the CLI commands you can use to configure and monitor Secure Mobility.

**Table 14-1** Secure Mobility CLI Commands

Command	Description
<code>musconfig</code>	<p>Use this command to enable Secure Mobility and configure how to identify remote users, either by IP address or by integrating with one or more Cisco adaptive security appliances.</p> <p><b>Note:</b> Changes made using this command cause the Web Proxy to restart.</p> <p>For more information on enabling and configuring Secure Mobility, see <a href="#">Enabling Secure Mobility, page 14-2</a>.</p>
<code>musstatus</code>	<p>Use this command to display information related to Secure Mobility when the Web Security appliance is integrated with an adaptive security appliance.</p> <p>This command displays the following information:</p> <ul style="list-style-type: none"> <li>• The status of the Web Security appliance connection with each adaptive security appliance.</li> <li>• The duration of the Web Security appliance connection with each adaptive security appliance in minutes.</li> <li>• The number of remote clients from each adaptive security appliance.</li> <li>• The number of remote clients being serviced, which is defined as the number of remote clients that have passed traffic through the Web Security appliance.</li> <li>• The total number of remote clients.</li> </ul>

# 15

## Controlling Access to SaaS Applications

---

- [SaaS Access Control Overview, page 15-1](#)
- [Understanding How SaaS Access Control Works, page 15-1](#)
- [Configuring the Appliance as an Identity Provider, page 15-5](#)
- [Creating SaaS Application Authentication Policies, page 15-8](#)

### SaaS Access Control Overview

Organizations are increasingly choosing to use software as a service (SaaS) applications instead of owning and managing software applications within the organization. SaaS applications typically reside “in the cloud” instead of on-premise inside your network. There are many potential benefits to using SaaS applications, such as cost savings, but there are also challenges, especially for IT administrators who have to manage access control to the SaaS applications.

Cisco offers the SaaS Access Control feature which provides IT administrators with seamless, secure controls necessary for managing access to SaaS applications and enforcing security policies. SaaS Access Control allows IT administrators to easily control authentication and authorization for users who need to access SaaS applications.

When you enable Cisco SaaS Access Control, users log into the configured SaaS applications using their network authentication user credentials. That means they use the same user name and password for all SaaS applications as well as network access. You can choose whether users are transparently signed in (single sign-on functionality) or prompted to enter their authentication user name and password.

Using Cisco SaaS Access Control with the proper access controls of your SaaS application allows you to:

- Control which users can access SaaS applications and from where.
- Increase usability for end users by requiring them to remember only one password.
- Quickly disable access to all SaaS applications when users are no longer employed by the organization. This is sometimes referred to as “zero day revocation.”
- Reduce the risk of phishing attacks that ask users to enter their SaaS user credentials.

### Understanding How SaaS Access Control Works

The SaaS Access Control solution uses the Security Assertion Markup Language (SAML) to authorize access to SaaS applications. It works with SaaS applications that are strictly compliant with SAML version 2.0.

SAML is an XML-based standard for exchanging authentication and authorization data between different secure networks, sometimes referred to as security domains. The main problem that SAML solves is single sign-on between different security domains. Typically, SAML is used when there are users in one domain accessing a network (a different domain) using a web browser. This is sometimes referred to as web browser single sign-on.

To achieve web browser single sign-on, a SAML dialogue must be engaged by an entity in each domain, which SAML defines using the following terms:

- **Identity provider.** An identity provider is an entity that produces SAML assertions. The identity provider is expected to authenticate its end users before producing a SAML assertion. The Web Security appliance is an identity provider.
- **Service provider.** A service provider is an entity that consumes SAML assertions. The SaaS applications you configure on the Web Security appliance are service providers. The service provider relies on the identity provider to identify the end user and communicate that identification to the service provider in the SAML assertion. The service provider makes an access control decision based on the assertion.

SAML assertions are containers of information passed between identity providers and service providers inside SAML requests and responses. Assertions contain statements (such as authentication and authorization statements) that service providers use to make access control decisions. Assertions start with the <saml:Assertion> tag.

SAML dialogues are called flows, and flows can be initiated by either provider:

- **Service provider initiated flow.** The service provider is contacted by an end user requesting access so it starts a SAML dialogue by contacting the identity provider to provide identification for the user. For service provider initiated flows, the end user accesses the service provider using a URL that contains the service provider's domain, such as `http://www.serviceprovider.com/<URI>`.
- **Identity provider initiated flow.** The identity provider starts a SAML dialogue by contacting the service provider requesting access on behalf of an end user. For identity provider initiated flows, the end user accesses the service provider using a URL that contains a local domain, such as `http://saas.example.com/<URI>`.

SaaS applications define whether they support service provider or identity provider initiated flows. For example, Salesforce supports identity provider initiated flows, Google Apps supports service provider initiated flows, and Cisco WebEx supports both.

The type of flow supported by a SaaS application determines how end users access the application. For more information, see [Understanding the Single Sign-On URL, page 15-4](#).



#### Note

This section does not provide a comprehensive discussion of SAML, nor how identity and security providers communicate with each other. For more detailed information, read about SAML at <http://docs.oasis-open.org/security/saml/v2.0/>.

## Authenticating SaaS Users

When users access a SaaS application, you can choose how to sign them into the SaaS application:

- Always prompt users for their local authentication credentials.
- Prompt users for their local authentication credentials if the Web Proxy obtained their user names using transparent user identification.
- Automatically sign in users to the SaaS application using their local authentication credentials.

Figure 15-1 shows where you configure how to sign in SaaS users in the SaaS Application Authentication Policy.

**Figure 15-1 Automatically Signing In SaaS Users**

Authentication: Select the authentication sequence or realm that will be used for authentication and authorization when this SaaS application is accessed. Create a new sequence or realm at Network > Authentication

All Realms ▾

SaaS SSO authentication Prompt ?

Always prompt SaaS users for proxy authentication

Prompt SaaS users who have been discovered by transparent user identification

Automatically sign in SaaS users

When you configure the SaaS Application Authentication Policy to automatically sign in users, the Web Proxy tries to log the user into the SaaS application using the authentication credentials already associated with the user without prompting the user to enter the credentials again. These credentials may have been manually entered by the user or obtained using transparent user identification.

However, users might be prompted to enter their authentication credentials in the web browser in some cases. When users are prompted for their credentials, a form filled with fields is displayed in the web browser where they can enter their credentials. This happens under the following circumstances:

This happens when no authentication information is associated with the user due to one of the following reasons:

- Authentication is not required for the user to browse the web.
- The user connects to the single sign-on URL before accessing any other website previously.
- The user was authenticated with an Identity that uses IP-based authentication surrogates, the “Client IP Idle Timeout” or the “Surrogate Timeout” value on the Web Security appliance has expired, and the user connects to the single sign-on URL before accessing any other website since the timeout expiration.
- The user was authenticated with an Identity that uses cookie-based authentication surrogates, the “Surrogate Timeout” value has expired, and the user connects to the single sign-on URL before accessing any other website since the timeout expiration.

For more information about the single sign-on URL, see [Understanding the Single Sign-On URL](#), page 15-4.



**Note**

Users may also be forced to enter authentication credentials if they have already authenticated with the Web Security appliance, but the user does not have the authorization to connect to the SaaS application. This might happen if the user is not authenticated against the policy’s authentication realm or is not one of the listed users in the policy’s authentication realm.

When users are prompted to authenticate, the authentication credentials are sent to the Web Proxy using a secure HTTPS connection. The appliance uses its own certificate and private key to create an HTTPS connection with the client by default. Most browsers will warn users that the certificate is not valid. To prevent users from seeing the invalid certificate message, you can upload a certificate and key pair your organization uses. For information about uploading a certificate and key, see [Uploading Certificates and Keys to Use with Credential Encryption and SaaS Access Control](#), page 20-24.



**Note**

To achieve single sign-on behavior using explicit forward requests for all authenticated users when the appliance is deployed in transparent mode, you must select the “Apply same surrogate settings to explicit forward requests” setting when you configure the Identity group.

## Authentication Requirements

Some service providers require a particular authentication mechanism to allow users to access the SaaS application. If a service provider requires an authentication context that is not supported by an identity provider, users cannot access the service provider using single sign-on from the identity provider.

Therefore, SaaS Access Control only works with SaaS applications that require an authentication mechanism supported by the Web Security appliance. Currently, the Web Proxy uses the “PasswordProtectedTransport” authentication mechanism. You configure this value when you create a SaaS Application Authentication Policy using the Authentication Context setting. However, administrators typically choose “Automatic” as the Authentication Context setting.

For more information on creating SaaS Application Authentication Policies, see [Creating SaaS Application Authentication Policies, page 15-8](#).

## Enabling SaaS Access Control

To enable SaaS Access Control, you must configure settings on both the Web Security appliance and the SaaS application. It is very important that the settings you configure on the appliance and SaaS application match each other appropriately.

When enabling SaaS Access Control, it is easiest to keep open a connection to the Web Security appliance and the SaaS application simultaneously. You will need to go back and forth between both components and copy and paste information between both.



### Note

For more information on configuring SaaS Access Control for particular SaaS applications, contact your technical sales representative or search the cisco.com website for additional information, such as white papers, knowledge base articles, or video tutorials.

To use SaaS Access Control, follow these steps:

1. **Configure the Web Security appliance as an identity provider.** For more information, see [Configuring the Appliance as an Identity Provider, page 15-5](#).
2. **Configure the SaaS application for single sign-on.** When configuring the SaaS application, you must also upload the certificate used on the Security Services > Identity Provider for SaaS page. For more information, see the SaaS application documentation.
3. **Create one or more SaaS Application Authentication Policies for each SaaS application.** For more information, see [Creating SaaS Application Authentication Policies, page 15-8](#).

## Understanding the Single Sign-On URL

After you configure the Web Security appliance as an identity provider and create a SaaS Application Authentication Policy for the SaaS application, the appliance creates a single sign-on URL (SSO URL).

How administrators use this URL depends on the flow type:

- **Identity provider initiated flows.** Administrators should make the single sign-on URL available to end users to access this SaaS application. For example, administrators can create an internal web page that includes this URL as a link. After users login, the appliance redirects users to the SaaS application.

- **Service Provider initiated flows.** Administrators should configure this URL in the SaaS application. The SaaS application uses the single sign-on URL to redirect the browser session depending on the “SaaS SSO Authentication Prompt” setting in the policy group:
  - **Always prompt SaaS users for proxy authentication.** A Web Security appliance page appears where users can enter their local authentication credentials. After entering valid credentials, users are logged into the SaaS application.
  - **Transparently sign in SaaS users.** Users are logged into the SaaS application automatically.

The Web Security appliance uses the application name configured in the SaaS Application Authentication Policy to generate the single sign-on URL. You can view the single sign-on URL on the Web Security Manager > SaaS Policies page after you submit the changes.

The single sign-on URL format is:

`http://IdentityProviderDomainName/SSOURL/ApplicationName`

Therefore, when the appliance Identity Provider Domain Name is `idp.example.com` and the application name in the SaaS Application Authentication Policy is `GoogleApps`, the single sign-on URL is:

`http://idp.example.com/SSOURL/GoogleApps`

## Using SaaS Access Control with Multiple Appliances

When you use multiple Web Security appliances with SaaS Access Control, you must perform the following steps:

- Configure the same Identity Provider Domain Name for each Web Security appliance.
- Configure the same Identity Provider Entity ID for each Web Security appliance.
- Upload the same certificate and private key to each appliance on the Security Services > Identity Provider for SaaS page. Then upload this certificate to each SaaS application you configure.

## Configuring the Appliance as an Identity Provider

When you configure the Web Security appliance as an identity provider, the settings you define apply to all SaaS applications it communicates with. The Web Security appliance uses a certificate and key to sign each SAML assertion it creates. You can either upload or generate the certificate and key.

After you choose which certificate and key to use for signing SAML assertions, you must upload the certificate to each SaaS application. You can do this using the Download Certificate link in the Signing Certificate area. Uploading the certificate ensures the SaaS application (service provider) has the Web Security appliance public key in order to form a trusted relationship between the service provider and the Web Security appliance (identity provider).

Consider the following rules and guidelines when you configure the Web Security appliance as an identity provider:

- The identity provider domain name must be resolvable within the network. For example, within the organization “example.com,” a transparent request to “`http://idp.example.com/`” should be network routable and can reach to the Web Security appliance within the network perimeter.
- If you intend to use multiple Web Security appliances with SaaS Access Control, you must enter the same Identity Provider Domain Name for each appliance and the same Identity Provider Entity ID for each appliance. For more information, see [Using SaaS Access Control with Multiple Appliances, page 15-5](#).

- After you generate on or upload a certificate and key to the appliance, you must upload the same certificate to each SaaS application with which the Web Security appliance will communicate. You can do this by downloading the certificate from the appliance first.
- Make note of the settings you configure when you configure the Web Security appliance as an identity provider. Some of these settings must be used when configuring the SaaS application for single sign-on. It is easiest to keep open a connection to the Web Security appliance and the SaaS application simultaneously. You will need to go back and forth between both components and copy and paste information between both
- The appliance constructs a single sign-on (SSO) login URL for each SaaS application based on the value you enter the Identity Provider Domain Name field and the SaaS application name configured in the SaaS policy. For more information, see [Understanding the Single Sign-On URL, page 15-4](#).

---

**Step 1** Navigate to the Security Services > Identity Provider for SaaS page.

**Step 2** Click **Edit Settings**.

**Step 3** In the Identity Provider Domain Name field, enter a virtual domain name to use to access the Web Security appliance as an identity provider instance.

The identity provider domain name should be resolvable within the network. For example, within the organization “example.com,” a transparent request to “http://idp.example.com/” should be network routable and can reach to the Web Security appliance within the network perimeter.



**Note**

If you intend to use multiple Web Security appliances with SaaS Access Control, you must enter the same Identity Provider Domain Name for each Web Security appliance. If you have only one appliance, you can use the appliance hostname as the Identity Provider Domain Name. For more information, see [Using SaaS Access Control with Multiple Appliances, page 15-5](#).

**Step 4** In the Identity Provider Entity ID field, enter the text you want to use that uniquely identifies this Web Security appliance as an identity provider to all SaaS applications it will communicate with.

A URI format based string is recommended, but you can enter any unique string. The URI string does not have to be network accessible. Record the value you enter here because you will need to use the same value when you configure the SaaS application for single sign-on.



**Note**

If you intend to use multiple Web Security appliances with SaaS Access Control, you must enter the same Identity Provider Entity ID for each Web Security appliance. For more information, see [Using SaaS Access Control with Multiple Appliances, page 15-5](#).

**Step 5** Configure a signing certificate the appliance should use when it communicates using a secure connection (in the SAML flow) with service providers. You can use either of the following methods to configure the certificate:

- **Uploaded certificate and key.** Go to step 6.
- **Generated certificate and key.** Go to step 7.



**Note**

If the appliance has both an uploaded certificate and key pair and a generated certificate and key pair, it only uses the certificate and key pair currently selected in the Signing Certificate section.

**Step 6** To upload a root certificate and key:

- a. Click Use Uploaded Certificate and Key.



- b. Click **Browse** for the Certificate field to navigate to the certificate file stored on the local machine. If the file you upload contains multiple certificates or keys, the Web Proxy uses the first certificate or key in the file.



---

**Note** The certificate file must be in PEM format. DER format is not supported.

---

- c. Click **Browse** for the Key field to navigate to the private key file. The private key must be unencrypted.



---

**Note** The key length must be 512, 1024, or 2048 bits. Also, the private key file must be in PEM format. DER format is not supported.

---

- d. Click **Upload Files** to transfer the certificate and key files to the Web Security appliance. The uploaded certificate information is displayed on the Edit Identity Provider Settings for SaaS Single Sign on page.



---

**Note** After you upload the certificate and key, you can download the generated certificate to transfer it to the SaaS applications with which the Web Security appliance will communicate. Do this using the Download Certificate link in the generated key area.

---

- e. Go to step 8.

**Step 7** To generate a certificate and key:

- a. Click the Use Generated Certificate and Key option.
- b. Click **Generate New Certificate and Key**.
- c. In the Generate Certificate and Key dialog box, enter the information to display in the signing certificate.



---

**Note** You can enter any ASCII character except the forward slash ( / ) in the Common Name field.

---

- d. Click **Generate**. The Web Security appliance generates the certificate with the data you entered and generates a key.

The generated certificate information is displayed on the Edit Identity Provider Settings for SaaS Single Sign on page.



---

**Note** After you generate the certificate and key, you can download the generated certificate to transfer it to the SaaS applications with which the Web Security appliance will communicate. Do this using the Download Certificate link in the generated key area.

---

- e. Optionally, you can download the Certificate Signing Request (CSR) using the Download Certificate Signing Request link so you can submit it to a certificate authority (CA). After you receive a signed certificate from the CA, click **Browse** and navigate to the signed certificate location. Click **Upload File**. You can do this anytime after generating the certificate on the appliance.

**Step 8** Submit and commit your changes.

---

## Creating SaaS Application Authentication Policies

After you configure the Web Security appliance as an identity provider and you configure a SaaS application for single sign-on, you can create a SaaS Application Authentication Policy so the Web Security appliance can communicate with the SaaS application and enable web browser single sign-on.

Consider the following rules and guidelines when you configure the SaaS application information in a SaaS Application Authentication Policy:

- The Assertion Consumer Service Location URL must be must be resolvable within the network.
- The appliance constructs a single sign-on (SSO) login URL for each SaaS application based on the value you enter the Identity Provider Domain Name field for the appliance and the SaaS application name configured in the SaaS policy. For more information, see [Understanding the Single Sign-On URL, page 15-4](#).

---

**Step 1** Navigate to the Web Security Manager > SaaS Policies page.

**Step 2** Click **Add Applications** to create a new policy for a particular SaaS application.

**Figure 15-2** Creating a SaaS Application Authentication Policy**New SaaS Application**

**SaaS Application**

**Enable**

Application Name: ?

Description:

Metadata for Service Provider: ?

**Configure Keys Manually**

Service Provider Entity ID: ?

Name ID Format: ?

Assertion Consumer Service URL: ?

**Import File from Hard Disk**

Authentication: *Select the authentication sequence or realm that will be used for authentication and authorization when this SaaS application is accessed. Create a new sequence or realm at Network > Authentication*

SaaS SSO authentication Prompt ?

Always prompt SaaS users for proxy authentication

Prompt SaaS users who have been discovered by transparent user identification

Automatically sign in SaaS users

SAML Username Mapping: ?

Expression Name

SAML Attribute Mapping: ? *Enter a list of attributes that will be sent to the service provider for attribute mapping.*

SAML Attribute	LDAP Attribute	
<input type="text"/>	<input type="text"/>	<input type="button" value="Add Row"/>
		<input type="button" value="Delete"/>

Authentication Context: ?

**Step 3** Configure the settings defined in [Table 15-1](#).

**Table 15-1** SaaS Application Authentication Policy Settings

Property	Description
Application Name	Enter a name to identify the SaaS application for this policy group. Each application name must be unique and only contain alphanumeric characters or the space character.  The Web Security appliance uses the application name to generate a single sign-on URL. For more information, see <a href="#">Understanding the Single Sign-On URL</a> , page 15-4.
Description	Optionally, enter a description for this SaaS application.

**Table 15-1 SaaS Application Authentication Policy Settings (continued)**

Property	Description
Metadata for Service Provider	<p>Configure the metadata that describes the service provider referenced in this policy group. You can either describe the service provider properties manually or upload a metadata file provided by the SaaS application.</p> <p>The Web Security appliance uses the metadata to determine how to communicate with the SaaS application (service provider) using SAML. Contact the SaaS application to learn the correct settings to configure the metadata.</p> <p>When you manually configure the metadata information, configure the following values:</p> <ul style="list-style-type: none"> <li>• <b>Service Provider Entity ID.</b> Enter the text (typically in URI format) the SaaS application uses to identify itself as a service provider.</li> <li>• <b>Name ID Format.</b> Enter the format the appliance should use to identify users in the SAML assertion it sends to service providers. The value you enter here must match the corresponding setting configured on the SaaS application.</li> <li>• <b>Assertion Consumer Service Location.</b> Enter the URL to where the Web Security appliance should send the SAML assertion it creates. Read the SaaS application documentation to determine that correct URL to use. Sometimes, this is referred to as the login URL.</li> </ul> <p><b>Note:</b> The metadata file is an XML document following the SAML standard that describes a service provider instance. Not all SaaS applications use metadata files, but for those that do, contact the SaaS application provider for the file.</p>
Authentication	<p>Choose the authentication realm or authentication sequence the Web Proxy should use to authenticate users accessing this SaaS application. Users must be a member of the authentication realm or authentication sequence to successfully access the SaaS application.</p> <p>In the SaaS SSO Authentication Prompt section, choose how to sign users into the SaaS application. You might want to prompt users for their credentials for applications that store sensitive data, such as sales or HR data, and transparently sign in users for applications that do not store sensitive data.</p> <p>For more information, see <a href="#">Authenticating SaaS Users, page 15-2</a>.</p>

**Table 15-1 SaaS Application Authentication Policy Settings (continued)**

Property	Description
User Name Identifier Mapping	<p>Specify how the Web Proxy should represent user names to the service provider in the SAML assertion.</p> <p>You can pass the user names as they are used inside your network (no mapping), or you can change the internal user names into a different format using one of the following methods:</p> <ul style="list-style-type: none"> <li>• <b>Fixed Rule mapping.</b> The user names sent to the service provider are based on the internal user name with a fixed string added before or after the internal user name. Enter the fixed string and %s for the internal user name.</li> <li>• <b>LDAP query.</b> The user names sent to the service provider are based on one or more LDAP query attributes. Enter an expression containing LDAP attribute fields and optional custom text. You must enclose attribute names in angled brackets. You can include any number of attributes. For example, for the LDAP attributes “user” and “domain,” you could enter <code>&lt;user&gt;@&lt;domain&gt;.com.</code></li> </ul>
Attribute Mapping Options	<p>Optionally, you can provide to the SaaS application additional information about the internal users from the LDAP authentication server if required by the SaaS application. Map each LDAP server attribute to a SAML attribute.</p> <p>For example, you could map the LDAP attribute “mail” to the SAML attribute “email.”</p>
Authentication Context	<p>Specify the authentication mechanism the Web Proxy uses to authenticate its internal users. Currently, the Web Proxy uses “PasswordProtectedTransport,” however, administrators typically choose “Automatic.”</p> <p><b>Note:</b> The authentication context informs the service provider which authentication mechanism the identity provider used to authenticate the internal users. Some service providers require a particular authentication mechanism to allow users to access the SaaS application. If a service provider requires an authentication context that is not supported by an identity provider, users cannot access the service provider using single sign-on from the identity provider.</p>

**Step 4** Submit and commit your changes.



# 16

## Notifying End Users

---

- [Notifying End Users of Organization Policies](#), page 16-1
- [Configuring General Settings for Notification Pages](#), page 16-3
- [Working With On-Box End-User Notification Pages](#), page 16-3
- [Defining End-User Notification Pages Off-Box](#), page 16-9
- [End-User Acknowledgement Page](#), page 16-11
- [Configuring the End-User URL Filtering Warning Page](#), page 16-15
- [Configuring FTP Notification Messages](#), page 16-16
- [Custom Text in Notification Pages](#), page 16-16
- [Notification Page Types](#), page 16-18

### Notifying End Users of Organization Policies

The Web Security appliance helps your organization implement and enforce policies for accessing the web. When a policy blocks a user from a website, you can configure the appliance to notify the user why it blocked the URL request. Web users see a webpage that explains that they were blocked from accessing a website and why they were blocked. These pages are called end-user notification pages. The Web Proxy can display different end-user notification pages depending on the reason it blocked the URL request. You can use the provided end-user notification pages stored on the appliance or define your own off-box.

Configure end-user notification pages on the Security Services > End-User Notification page. [Figure 16-1](#) shows where you configure end-user notification settings.

**Figure 16-1** Security Services > End-User Notification Page

## End-User Notification

End-User Notification	
<b>HTTP General Settings</b>	
Language:	English
Logo Image:	No Image
<b>HTTP End-User Acknowledgement Page</b>	
End-User Acknowledgement:	Disabled
Custom Message:	Undefined
<b>HTTP End-User Notification Pages</b>	
Notification Type:	Use On-box End User Notification
Custom Message:	Undefined
Contact Information:	your corporate network administrator
End-User Misclassification Reporting:	Disabled
<b>End-User URL Filtering Warning Page</b>	
Time Between Warning:	1h
Custom Message:	Undefined
<b>Native FTP End-User Notification Pages</b>	
Language:	English
Custom Message:	Undefined
<a href="#">Edit Settings...</a>	

You can configure the following types of notification pages and settings:

- **On-box end-user notification pages.** The Web Proxy displays different, predefined notification pages depending on the reason for blocking the URL request. You can customize these pages. For more information, see [Working With On-Box End-User Notification Pages, page 16-3](#).
- **Off-box end-user notification pages.** You can configure the Web Proxy to redirect all HTTP end-user notification pages to a specific URL. The Web Proxy includes parameters in the redirected URL that explain the reasons for the block so the server in the redirected URL can customize the page it displays. For more information, see [Defining End-User Notification Pages Off-Box, page 16-9](#).
- **End-user acknowledgement page.** You can configure the Web Proxy to inform users that it is filtering and monitoring their web activity. An end-user acknowledgement page is displayed when a user first accesses a browser after a certain period of time. When the end-user acknowledgement page appears, users must click a link to access the original site requested or any other website. Language and logo settings apply to the end-user acknowledgement page as well as the notification pages. For more information, see [End-User Acknowledgement Page, page 16-11](#).
- **End-user URL filtering warning page.** You can configure the Web Proxy to warn users that a site does not meet the organization's acceptable use policies and allow them to continue if they choose. An end-user URL filtering warning page is displayed when a user first accesses a website in a particular URL category after a certain period of time. You can also configure the warning page when a user accesses adult content when the site content ratings feature is enabled. When the warning page appears, users can click a link to access the original site requested. Language and logo settings apply to the end-user URL filtering warning page as well as the notification pages. For more information, see [Warning Users and Allowing Them to Continue, page 17-20](#).
- **FTP notification messages.** The FTP Proxy displays a different, predefined notification messages depending on the reason for blocking a native FTP transaction. You can customize these pages with a custom message. For more information, see [Configuring FTP Notification Messages, page 16-16](#).
- **General notification settings.** You can configure the language used in on-box end-user notification pages for both HTTP and FTP. You can also configure a logo to use for on-box end-user notification pages for HTTP requests. For more information, see [Configuring General Settings for Notification Pages, page 16-3](#).



# Configuring General Settings for Notification Pages

You can configure the following general settings:

- **Language.** You can configure a different language for HTTP and FTP end-user notification pages. The HTTP language setting applies to all HTTP notification pages (acknowledgement, on-box end-user, customized end-user, and end-user URL filtering warning), and the FTP language applies to all FTP notification messages.
- **Logo.** You can configure a logo for HTTP end-user notification pages only. The logo setting applies to all HTTP notification pages.

---

**Step 1** Navigate to the Security Services > End-User Notification page.

**Step 2** Click **Edit Settings**.

**Step 3** In the General Settings section under the HTTP/HTTPS section, select the language the Web Proxy should use when displaying HTTP notification pages. You can choose any of the following languages:

- English
- French
- German
- Italian
- Spanish
- Japanese
- Korean
- Portuguese
- Russian
- Thai
- Traditional Chinese
- Simplified Chinese

**Step 4** Choose whether or not to use a logo on each notification page. You can specify the Cisco logo or any graphic file referenced at the URL you enter in the Use Custom Logo field.



**Note** See [Custom Text and Logos: Authentication, and End-User Acknowledgement Pages, page 16-17](#) for more information about working with custom logos.

---

**Step 5** Submit and commit your changes.

---

## Working With On-Box End-User Notification Pages

When you choose on-box end-user notification pages, the Web Proxy displays a different page depending on the reason why it blocked the original page. However, you can still customize each page to make them specific to your organization.

You can customize the following features:

- Custom message
- Contact information
- Allow end-users to report misclassified pages to Cisco

You can also manually edit each on-box end-user notification page stored on the Web Security appliance. For more information about how to do this, see [Editing On-Box End-User Notification Pages, page 16-5](#).

## Configuring On-Box End-User Notification Pages

**Step 1** Navigate to the Security Services > End-User Notification page, and click **Edit Settings**.

**Step 2** From the Notification Type field, choose Use On Box End User Notification.

**Step 3** Configure the on-box end-user notification page settings.

[Table 16-1](#) describes the settings you can configure for on-box end-user notification pages.

**Table 16-1 On-Box End-User Notification Page Settings**

Setting	Description
Custom Message	<p>Choose whether or not to include additional text you specify on each notification page.</p> <p>When you enter a custom message, AsyncOS places the message before the last sentence on the notification page which includes the contact information.</p> <p>You can include some HTML tags in lower case to format the text. For a list of supported HTML tags, see <a href="#">Supported HTML Tags in Notification Pages, page 16-17</a>.</p> <p>See <a href="#">Custom Text and Logos: Authentication, and End-User Acknowledgement Pages, page 16-17</a> for more information about working with custom messages.</p>

**Table 16-1** On-Box End-User Notification Page Settings (continued)

Setting	Description
Contact Information	<p>Choose whether or not to customize the contact information listed on each notification page.</p> <p>AsyncOS displays the contact information sentence as the last sentence on a page, before providing notification codes that users can provide to the network administrator.</p>
End-User Misclassification Reporting	<p>Choose whether or not users can report misclassified URLs to Cisco.</p> <p>When you enable this option, an additional button appears on the on-box end-user notification pages for sites blocked due to suspected malware or URL filters. This button allows the user to report when they believe the page has been misclassified. It does not appear for pages blocked due to other policy settings.</p> <p>When a user presses this button, data about the blocked request gets sent to the Web Security appliance. AsyncOS logs the information in the Feedback Log, summarizes the data, and forwards it to Cisco.</p> <p>This feature helps improve efficiency for administrators, and the Cisco IronPort Customer Support process. Additionally, misclassification reports improve the efficacy of URL filtering.</p> <p>For more information on reporting uncategorized and misclassified URLs to Cisco, see <a href="#">Reporting Uncategorized and Misclassified URLs, page 17-3</a>.</p>

**Step 4** Click the “Preview Notification Page Customization” link to view the current end-user notification page in a separate browser window.



**Note** If the end-user notification pages have been edited (as described in [Editing On-Box End-User Notification Pages, page 16-5](#)), this preview functionality is not available.

**Step 5** Submit and commit your changes.

## Editing On-Box End-User Notification Pages

Each on-box end-user notification page is stored on the Web Security appliance as an HTML file. You can edit the content of these HTML pages to include additional text or to edit the overall look and feel of each page.

You can use variables in the HTML files to display specific information to the user. You can also turn each variable into a conditional variable to create if-then statements. For more information, see [Using Variables in Customized On-Box End-User Notification Pages, page 16-8](#).

Table 16-2 describes the variables you can include in customized end-user notification pages.

**Table 16-2 Variables for Customized End-User Notification Pages**

Variable	Description	Always Evaluates to TRUE if Used as Conditional Variable
%a	Authentication realm for FTP	No
%A	ARP address	Yes
%b	User-agent name	No
%B	Blocking reason, such as BLOCK-SRC or BLOCK-TYPE	No
%c	Error page contact person	Yes
%C	Entire Set-Cookie: header line, or empty string	No
%d	Client IP address	Yes
%D	User name	No
%e	Error page email address	Yes
%E	The error page logo URL	No
%f	User feedback section	No
%F	The URL for user feedback	No
%g	The web category name, if available	Yes
%G	Maximum file size allowed in MB	No
%h	The hostname of the proxy	Yes
%H	The server name of the URL	Yes
%i	Transaction ID as a hexadecimal number	Yes
%I	Management IP Address	Yes
%j	URL category warning page custom text	No
%k	Redirection link for the end-user acknowledgement page and end-user URL filtering warning page	No
%K	Response file type	No
%l	WWW-Authenticate: header line	No
%L	Proxy-Authenticate: header line	No
%M	The Method of the request, such as “GET” or “POST”	Yes
%n	Malware category name, if available	No
%N	Malware threat name, if available	No
%o	Web reputation threat type, if available	No
%O	Web reputation threat reason, if available	No
%p	String for the Proxy-Connection HTTP header	Yes
%P	Protocol	Yes
%q	Identity policy group name	Yes
%Q	Policy group name for non-Identity polices	Yes
%r	Redirect URL	No

**Table 16-2** Variables for Customized End-User Notification Pages (continued)

Variable	Description	Always Evaluates to TRUE if Used as Conditional Variable
%R	Re-authentication is offered. This variable outputs an empty string when false and a space when true, so it is not useful to use it alone. Instead, use it as condition variable. For more information, see <a href="#">Using Variables in Customized On-Box End-User Notification Pages, page 16-8</a> .  For more information on re-authentication, see <a href="#">Allowing Users to Re-Authenticate, page 20-25</a> .	No
%S	The signature of the proxy	No, always evaluates to FALSE
%t	Timestamp in Unix seconds plus milliseconds	Yes
%T	The date	Yes
%u	The URI part of the URL (the URL excluding the server name)	Yes
%U	The full URL of the request	Yes
%v	HTTP protocol version	Yes
%W	Management WebUI port	Yes
%X	Extended blocking code. This is a 16-byte base64 value that encodes the most of the web reputation and anti-malware information logged in the access log, such as the ACL decision tag and WBRs score.	Yes
%Y	Administrator custom text string, if set, else empty	No
%y	End-user acknowledgement page custom text	Yes
%z	Web reputation score	Yes
%Z	DLP metadata	Yes
%%	Prints the percent symbol (%) in the notification page	N/A

To edit the on-box end-user notification pages:

- 
- Step 1** Use an FTP client to connect to the Web Security appliance.
  - Step 2** Navigate to the `configuration\ Eun` directory.  
In this directory are subdirectories for each supported language for end-user notification pages.
  - Step 3** Download the language directory files for the on-box end-user notification pages you want to edit.
  - Step 4** On your local machine, use a text or HTML editor to edit each HTML file for the on-box end-user notification pages.  
  
For a list of rules and guidelines, see [Rules and Guidelines for Editing On-Box End-User Notification Pages, page 16-8](#).
  - Step 5** Use the FTP client to upload the customized HTML files to the same directory from which you downloaded them in step 3.
  - Step 6** Open an SSH client and connect to the Web Security appliance.

**Step 7** Run the `advancedproxyconfig > EUN CLI` command.

**Step 8** Type `2` to use the custom end-user notification pages.



**Note** If the custom end-user notification pages option is currently enabled when you update the HTML files, you must type `1` to refresh the custom end-user notification pages. If you do not do this, the new files do not take effect until the Web Proxy restarts.

**Step 9** Commit your change, and close the SSH client.

## Rules and Guidelines for Editing On-Box End-User Notification Pages

Use the following rules and guidelines when editing on-box end-user notification pages:

- Each customized on-box end-user notification page file must be a valid HTML file. For a list of HTML tags you can include, see [Supported HTML Tags in Notification Pages, page 16-17](#).
- The customized on-box end-user notification page file names must exactly match the file names shipped with the Web Security appliance.
- Do not include any links to URLs in the HTML files. Any link included in the notification pages are subject to the access control rules defined in the Access Policies and users might end up in a recursive loop.
- If the configuration\eun directory does not contain a particular file with the required name, then the appliance displays the standard on-box end-user notification page.
- For new customized on-box end-user notification pages to go into effect, you must first upload the customized files to the appliance and then enable the customized files using the `advancedproxyconfig > EUN CLI` command.

## Using Variables in Customized On-Box End-User Notification Pages

When editing on-box end-user notification pages, you can include conditional variables to create if-then statements to take different actions depending on the current state. For example, you can create a customized on-box end-user notification page that includes a redirect URL (`%r`) if re-authentication is offered (`%R`). In this example, you would create a conditional variable out of `%R`.

[Table 16-3](#) describes the different conditional variable formats.

**Table 16-3** *Creating Conditional Variables in End-User Notification Pages*

Conditional Variable Format	Description
<code>%?V</code>	This conditional variable evaluates to TRUE if the output of variable <code>%V</code> is not empty.
<code>%!V</code>	Represents the following condition: <code>else</code> Use this with the <code>%?V</code> conditional variable.
<code>%#V</code>	Represents the following condition: <code>endif</code> Use this with the <code>%?V</code> conditional variable.



Then AsyncOS creates the following redirected URL:

```
http://www.example.com/eun.policy.html?Time=21/Jun/
2007:23:22:25%20%2B0000&ID=0000000004&Client_IP=172.17.0.8&User=-
&Site=www.espn.com&URI=index.html&Status_Code=403&Decision_Tag=
BLOCK_WEBCAT-DefaultGroup-DefaultGroup-NONE-NONE-DefaultRouting
&URL_Cat=Sports%20and%20Recreation&WBRs=-&DVS_Verdict=-&
DVS_ThreatName=-&Reauth_URL=-
```

## End-User Notification Page Parameters

AsyncOS passes the parameters to the web server as standard URL Parameters in the HTTP GET request. It uses the following format:

```
<notification_page_url>?param1=value1&param2=value2
```

Table 16-4 describes the parameters AsyncOS includes in the query string.

**Table 16-4** End-User Notification Parameters for Redirected URLs

Parameter Name	Description
Time	Date and time of the transaction.
ID	Transaction ID.
Client_IP	IP address of the client.
User	Username of the client making the request, if available.
Site	Hostname of the destination in the HTTP request.
URI	URL path specified in the HTTP request.
Status_Code	HTTP status code for the request.
Decision_Tag	ACL decision tag as defined in the Access log entry that indicates how the DVS engine handled the transaction.  For more information about ACL decision tags, see <a href="#">ACL Decision Tags, page 24-17</a> .
URL_Cat	URL category that the URL filtering engine assigned to the transaction request.  For a list of the different URL categories, see <a href="#">URL Category Descriptions, page 17-25</a> .  <b>Note:</b> AsyncOS for Web sends the entire URL category name for both predefined and user defined URL categories. It performs URL encoding on the category name, so spaces are written as "%20".
WBRs	WBRs score that the Web Reputation Filters assigned to the URL in the request.
DVS_Verdict	Malware category that the DVS engine assigns to the transaction.  For more information about malware categories, see <a href="#">Malware Scanning Verdict Values, page 24-38</a> .



**Table 16-4** End-User Notification Parameters for Redirected URLs (continued)

Parameter Name	Description
DVS_ThreatName	The name of the malware found by the DVS engine.
Reauth_URL	<p>A URL that users can click to authenticate again if the user is blocked from a website due to a restrictive URL filtering policy. Use this parameter when the “Enable Re-Authentication Prompt If End User Blocked by URL Category or User Session Restriction” global authentication setting is enabled and the user is blocked from a website due to a blocked URL category.</p> <p>To use this parameter, make sure the CGI script performs the following steps:</p> <ol style="list-style-type: none"> <li>1. Get the value of <code>Reauth_Url</code> parameter.</li> <li>2. URL-decode the value.</li> <li>3. Base64 decode the value and get the actual re-authentication URL.</li> <li>4. Include the decoded URL on the end-user notification page in some way, either as a link or button, along with instructions for users informing them they can click the link and enter new authentication credentials that allow greater access.</li> </ol> <p>For more information, see <a href="#">Allowing Users to Re-Authenticate, page 20-25</a>.</p>

**Note**

AsyncOS always includes all parameters in each redirected URL. If no value exists for a particular parameter, AsyncOS passes a hyphen (-).

## Redirecting End-User Notification Pages to a Custom URL

- Step 1** Navigate to the Security Services > End-User Notification page, and click **Edit Settings**.
- Step 2** From the Notification Type field, choose Redirect to Custom URL.
- Step 3** In the Notification Page URL field, enter the URL to which you want to redirect blocked websites.

**Note**

You can choose whether or not to preview the URL you enter by clicking the Preview Custom URL link.

- Step 4** Submit and commit your changes.

## End-User Acknowledgement Page

You can configure the Web Security appliance to inform users that it is filtering and monitoring their web activity. The appliance does this by displaying an end-user acknowledgement page when a user first accesses a browser after a certain period of time. When the end-user acknowledgement page appears, users must click a link to access the original site requested or any other website.

You might want to use an end-user acknowledgement page to force users to explicitly agree to the terms and conditions for browsing the World Wide Web from the organization's network. This might be useful when the Web Proxy is in transparent mode because web users will not otherwise know that their web transactions are being filtered and monitored for security purposes.

When you configure the appliance to display an end-user acknowledgement page, it does so for every user accessing the web using HTTP or HTTPS. It displays the end-user acknowledgement page when a user tries to access a website for the first time, or after a configured time interval.

The Web Proxy tracks users by username if authentication has made a username available. If no user name is available, you can choose how to track users, either by IP address or web browser session cookie.

**Note**

Native FTP transactions are exempt from the end-user acknowledgement page.

Table 16-5 describes the settings you can configure when you enable the end-user acknowledgement page.

**Table 16-5** *End-User Acknowledgement Page Settings*

Setting	Description
<b>Time Between Acknowledgements</b>	<p>The Time Between Acknowledgements determines how often the Web Proxy displays the end-user acknowledgement page for each user. Once a user clicks the link on the end-user acknowledgement page, the Web Proxy considers that user to have acknowledged the proxy for the time you enter for the Time Between Acknowledgements. This setting applies to users tracked by username and users tracked by IP address or session cookie. You can specify any value from 30 to 2678400 seconds (one month). Default is one day (86400 seconds).</p> <p>When the Time Between Acknowledgements changes and is committed, the Web Proxy uses the new value even for users who have already acknowledged the Web Proxy.</p>
<b>Inactivity Timeout</b>	<p>The Inactivity Timeout determines how long a user tracked and acknowledged by IP address or session cookie (unauthenticated users only) can be idle before the user is no longer considered acknowledged. You can specify any value from 30 to 2678400 seconds (one month). Default is four hours (14400 seconds).</p>

**Table 16-5** *End-User Acknowledgement Page Settings*

<b>Setting</b>	<b>Description</b>
<b>Surrogate Type</b>	<p>The Surrogate Type determines which method the Web Proxy uses to track the user:</p> <ul style="list-style-type: none"> <li> <b>IP Address.</b> If you select IP Address, the Web Proxy allows the user at that IP address to use any web browser or non-browser HTTP process to access the web once the user clicks the link on the end-user acknowledgement page. Tracking the user by IP address allows the user to access the web until the Web Proxy displays a new end-user acknowledgement page due to inactivity or the configured time interval for new acknowledgements. Unlike tracking by a session cookie, tracking by IP address allows the user to open up multiple web browser applications and not have to agree to the end-user acknowledgement unless the configured time interval has expired. </li> </ul> <p><b>Note:</b> When IP address is configured and the user is authenticated, the Web Proxy tracks users by username instead of IP address.</p> <ul style="list-style-type: none"> <li> <b>Session Cookie.</b> If you select Session Cookie, the Web Proxy sends the user's web browser a cookie when the user clicks the link on the end-user acknowledgement page and uses the cookie to track their session. Users can continue to access the web using their web browser until the Time Between Acknowledgements value expires, they have been inactive longer than the allotted time, or they close their web browser. You might want to use session cookies to prevent non-browser HTTP client applications from accessing the web without the end user's knowledge, such as malware clients. </li> </ul> <p>If the user using a non-browser HTTP client application, they must be able to click the link on the end-user acknowledgement page to access the web. If the user opens a second web browser application, the user must go through the end-user acknowledgement process again in order for the Web Proxy to send a session cookie to the second web browser.</p> <p><b>Note:</b> Using a session cookie to track users when the client accesses HTTPS sites or FTP servers using FTP over HTTP does not work. For more information on working around these issues, see <a href="#">Accessing HTTPS and FTP Sites with the End-User Acknowledgement Page</a>, page 16-14.</p>
<b>Custom message</b>	<p>The custom message is text you enter that appears on every end-user acknowledgement page. You can include some simple HTML tags to format the text. For example, you can change the color and size of the text, or make it italicized. See <a href="#">Custom Text in Notification Pages</a>, page 16-16 for more information.</p> <p><b>Note</b> You can only include a custom message when you configure the end-user acknowledgement page in the web interface, versus the CLI.</p>

Consider the following rules and guidelines when enabling the end-user acknowledgement page:

- When a user is tracked by IP address, the appliance uses the shortest value for maximum time interval and maximum IP address idle timeout to determine when to display the end-user acknowledgement page again.

- When a user is tracked using a session cookie, the Web Proxy displays the end-user acknowledgement page again if the user closes and then reopens their web browser or opens a second web browser application.
- Using a session cookie to track users when the client accesses HTTPS sites or FTP servers using FTP over HTTP does not work. For more information on working around these issues, see [Accessing HTTPS and FTP Sites with the End-User Acknowledgement Page, page 16-14](#).
- When the appliance is deployed in explicit forward mode and a user goes to an HTTPS site, the end-user acknowledgement page includes only the domain name in the link that redirects the user to the originally requested URL. If the originally requested URL contains text after the domain name, that text is truncated.
- When the end-user acknowledgement page is displayed to a user, the access log entry for that transaction shows OTHER as the ACL decision tag. This is because the originally requested URL was blocked, and instead the user was shown the end-user acknowledgement page.

## Accessing HTTPS and FTP Sites with the End-User Acknowledgement Page

The end-user acknowledgement page works because it displays an HTML page to the end user that forces them to click an acceptable use policy agreement. After users click the link, the Web Proxy redirects clients to the originally requested website. It keeps track of when users accepted the end-user acknowledgement page using a surrogate (either by IP address or web browser session cookie) if no username is available for the user.

However, using a session cookie to track users when the client accesses HTTPS sites or FTP servers using FTP over HTTP does not work.

- **HTTPS.** The Web Proxy tracks whether the user has acknowledged the end-user acknowledgement page with a cookie, but it cannot obtain the cookie unless it decrypts the transaction. You can choose to either bypass (pass through) or drop HTTPS requests when the end-user acknowledgement page is enabled and tracks users using session cookies. Do this using the `advancedproxyconfig > EUN` CLI command, and choose bypass for the “Action to be taken for HTTPS requests with Session based EUA (“bypass” or “drop”).” command.
- **FTP over HTTP.** Web browsers never send cookies for FTP over HTTP transactions, so the Web Proxy cannot obtain the cookie. To work around this, you can exempt FTP over HTTP transactions from requiring the end-user acknowledgement page. Do this by creating a custom URL category using “ftp://” as the regular expression (without the quotes) and defining an Identity policy that exempts users from the end-user acknowledgement page for this custom URL category.

## Configuring the End-User Acknowledgement Page

You can enable and configure the end-user acknowledgement page in the web interface or the command line interface. However, when you configure the end-user acknowledgement page in the web interface, you can include a custom message that appears on each page. You can include some simple HTML tags in the custom message, such as font color and size.

In the CLI, use `advancedproxyconfig > eun`.

- 
- Step 1** Navigate to the Security Services > End-User Notification page.
  - Step 2** Click **Edit Settings**.

- Step 3** In the End-User Acknowledgement Page section, enable the “Require end-user to click through acknowledgement page” field. See [Custom Text and Logos: Authentication, and End-User Acknowledgement Pages, page 16-17](#) for information about how this feature works with custom messages.
- Step 4** In the Time Between Acknowledgements field, enter the time interval the appliance uses between displaying the end-user acknowledgement page.
- You can specify any value from 30 to 2678400 seconds (one month). Default is 1 day (86400 seconds). You can enter the value in seconds, minutes, or days. Use ‘s’ for seconds, ‘m’ for minutes, and ‘d’ for days.
- Step 5** In the Inactivity Timeout field, enter the maximum IP address idle timeout.
- You can specify any value from 30 to 2678400 seconds (one month). Default is four hours (14400 seconds). You can enter the value in seconds, minutes, or days. Use ‘s’ for seconds, ‘m’ for minutes, and ‘d’ for days.
- Step 6** Select IP Address or Session Cookie for the Surrogate Type.
- Step 7** In the Custom Message field, enter any text you want to appear on every end-user acknowledgement page.
- You can include some HTML tags in lower case to format the text. For a list of supported HTML tags, see [Supported HTML Tags in Notification Pages, page 16-17](#).
- For example:
- ```
Please acknowledge the following statements <i>before</i> accessing the Internet.
```
- Step 8** Click the “Preview Acknowledgment Page Customization” link to view the current end-user acknowledgement page in a separate browser window.
- Step 9** Submit and commit your changes.

## Configuring the End-User URL Filtering Warning Page

You can configure the end-user URL filtering warning page on the Security Services > End-User Notification page. You can include some simple HTML tags in the custom message, such as font color and size.

- Step 1** Navigate to the Security Services > End-User Notification page, and click **Edit Settings**.
- Step 2** Scroll down to the End-User URL Filtering Warning Page section.

**Figure 16-2** Editing End-User URL Filtering Warning Page Settings

- Step 3** In the Time Between Warning field, enter the time interval the Web Proxy uses between displaying the end-user URL filtering warning page for each URL category per user.
- Once a user clicks the continue link on the end-user URL filtering warning page, the Web Proxy considers that user to have acknowledged the warning for the time you enter here. This setting applies to users tracked by username and users tracked by IP address.
- You can specify any value from 30 to 2678400 seconds (one month). Default is 1 hour (3600 seconds). You can enter the value in seconds, minutes, or days. Use ‘s’ for seconds, ‘m’ for minutes, and ‘d’ for days.
- Step 4** In the Custom Message field, enter any text you want to appear on every end-user URL filtering warning page.
- You might want to include text for the organization’s acceptable use policies, or include a link to a page that details the acceptable use policies.
- You can include some HTML tags in lower case to format the text. For a list of supported HTML tags, see [Supported HTML Tags in Notification Pages, page 16-17](#).
- For example:
- ```
Please acknowledge the following statements <i>before</i> accessing the Internet.
```
- Step 5** Click the “Preview URL Category Warning Page Customization” link to view the current end-user URL filtering warning page in a separate browser window.
- Step 6** Submit and commit your changes.
- 

## Configuring FTP Notification Messages

The FTP Proxy displays a predefined notification message to native FTP clients when the FTP Proxy cannot establish a connection with the FTP server for any reason, such as an error with FTP Proxy authentication or a bad reputation for the server domain name.

- 
- Step 1** Navigate to the Security Services > End-User Notification page, and click **Edit Settings**.
- Step 2** Scroll down to the Native FTP section.
- Step 3** In the Language field, select the language to use when displaying native FTP notification messages.
- Step 4** In the Custom Message field, enter the text you want to display in every native FTP notification message.
- Step 5** Submit and commit your changes.
- 

## Custom Text in Notification Pages

The following sections apply to custom text entered for on-box end-user notification and end-user acknowledgement pages.

## Supported HTML Tags in Notification Pages

You can format the text in on-box end-user notification and end-user acknowledgement pages using some HTML tags. Tags must be in lower case and follow standard HTML syntax (closing tags, etc.).

You can use the following HTML tags.

- `<a></a>`
- `<span></span>`
- `<b></b>`
- `<big></big>`
- `<br>`
- `<code></code>`
- `<em></em>`
- `<i></i>`
- `<small></small>`
- `<strong></strong>`

For example, you can make some text italic:

```
Please acknowledge the following statements before accessing the Internet.
```

With the `<span>` tag, you can use any CSS style to format text. For example, you can make some text red:

```
Warning: You must acknowledge the following statements before accessing the Internet.
```

## Custom Text and Logos: Authentication, and End-User Acknowledgement Pages

All combinations of URL paths and domain names in embedded links within custom text and the custom logo in on-box end-user notification, end-user acknowledgement, and end-user URL filtering warning pages are exempted from the following:

- User authentication
- End-user acknowledgment
- All scanning, such as malware scanning and web reputation scoring

For example, if the following URLs are embedded in custom text:

```
http://www.example.com/index.html
```

```
http://www.mycompany.com/logo.jpg
```

Then all of the following URLs will also be treated as exempt from all scanning:

```
http://www.example.com/index.html
```

```
http://www.mycompany.com/logo.jpg
```

```
http://www.example.com/logo.jpg
```

```
http://www.mycompany.com/index.html
```

Also, where an embedded URL is of the form: `<protocol>://<domain-name>/<directory path>/` then all sub-files and sub-directories under that directory path on the host will also be exempted from all scanning.

For example, if the following URL is embedded: `http://www.example.com/gallery2/` URLs such as `http://www.example.com/gallery2/main.php` will also be treated as exempt.

This allows administrators to create a more sophisticated page with embedded content so long as the embedded content is relative to the initial URL. However, administrators should also take care when deciding which paths to include as links and custom logos.

## Notification Page Types

Users accessing the Internet sometimes cannot access the server they want. By default, the Web Proxy displays a notification page informing users they were blocked and the reason for the block. This section lists and describes all possible notification pages a user might see while accessing the Internet.

Possible reasons that cause notification pages to appear include the following:

- End-user notification pages are enabled and the user accessed the Internet in a way that violated an Access Policy.
- End-user notification pages are configured to allow end-users to report misclassified pages to Cisco and the user reported a misclassified page.
- The end-user acknowledgement page is enabled and the user accessed the Internet for the first time since the timeout period expired.
- The Web Security appliance could not access the server requested due to an external error, such as DNS failure or an unavailable server.

Most notification pages display a different set of codes that may help administrators or Cisco IronPort Customer Support troubleshoot any potential problem. Some codes are for Cisco internal use only. The different codes that might appear in the notification pages are the same as the variables you can include in customized notification pages, as shown in [Table 16-2 on page 16-6](#).

[Table 16-6](#) describes the different notification pages users might encounter.

**Table 16-6 Notification Page Types**

File Name and Notification Title	Notification Description	Notification Text
ERR_ACCEPTED Feedback Accepted, Thank You	Notification page that is displayed after the users uses the “Report Misclassification” option.	The misclassification report has been sent. Thank you for your feedback.
ERR_ADAPTIVE_SECURITY Policy: General	Block page that is displayed when the user is blocked due to the Adaptive Scanning feature.	Based on your organization’s security policies, this web site <code>&lt;URL&gt;</code> has been blocked because its content has been determined to be a security risk.



Table 16-6 Notification Page Types (continued)

File Name and Notification Title	Notification Description	Notification Text
ERR_ADULT_CONTENT Policy Acknowledgement	The warning page that is displayed when the end-user accesses a page that is classified as adult content. Users can click an acknowledgement link to continue to the originally requested site.	You are trying to visit a web page whose content are rated as explicit or adult. By clicking the link below, you acknowledge that you have read and agree with the organization's policies that govern the usage of the Internet for this type of content. Data about your browsing behavior may be monitored and recorded. You will be periodically asked to acknowledge this statement for continued access to this kind of web page.  Click here to accept this statement and access the Internet.
ERR_AVC Policy: Application Controls	Block page that is displayed when the user is blocked due to the Application Visibility and Control engine.	Based on your organization's access policies, access to application %1 of type %2 has been blocked.
ERR_BAD_REQUEST Bad Request	Error page that results from an invalid transaction request.	The system cannot process this request. A non-standard browser may have generated an invalid HTTP request.  If you are using a standard browser, please retry the request.
ERR_BLOCK_DEST Policy: Destination	Block page that is displayed when the user tries to access a blocked website address.	Based on your organization's Access Policies, access to this web site <URL> has been blocked.
ERR_BROWSER Security: Browser	Block page that is displayed when the transaction request comes from an application that has been identified to be compromised by malware or spyware.	Based on your organization's Access Policies, requests from your computer have been blocked because it has been determined to be a security threat to the organization's network. Your browser may have been compromised by a malware/spyware agent identified as "<malware name>".  Please contact <contact name> <email address> and provide the codes shown below.  If you are using a non-standard browser and believe it has been misclassified, use the button below to report this misclassification.
ERR_BROWSER_CUSTOM Policy: Browser	Block page that is displayed when the transaction request comes from a blocked user agent.	Based on your organization's Access Policies, requests from your browser have been blocked. This browser "<browser type>" is not permitted due to potential security risks.
ERR_CERT_INVALID Invalid Certificate	Block page that is displayed when the requested HTTPS site uses an invalid certificate.	A secure session cannot be established because the site <hostname> provided an invalid certificate.

Table 16-6 Notification Page Types (continued)

File Name and Notification Title	Notification Description	Notification Text
ERR_CONTINUE_UNACKNOWLEDGED Policy Acknowledgement	Warning page that is displayed when the user requests a site that is in a custom URL category that is assigned the Warn action. Users can click an acknowledgement link to continue to the originally requested site.	You are trying to visit a web page that falls under the URL Category <i>&lt;URL category&gt;</i> . By clicking the link below, you acknowledge that you have read and agree with the organization's policies that govern the usage of the Internet for this type of content. Data about your browsing behavior may be monitored and recorded. You will be periodically asked to acknowledge this statement for continued access to this kind of web page.  Click here to accept this statement and access the Internet.
ERR_DNS_FAIL DNS Failure	Error page that is displayed when the requested URL contains an invalid domain name.	The hostname resolution (DNS lookup) for this hostname <i>&lt;hostname&gt;</i> has failed. The Internet address may be misspelled or obsolete, the host <i>&lt;hostname&gt;</i> may be temporarily unavailable, or the DNS server may be unresponsive.  Please check the spelling of the Internet address entered. If it is correct, try this request later.
ERR_EXPECTATION_FAILED Expectation Failed	Error page that is displayed when the transaction request triggers the HTTP 417 "Expectation Failed" response.	The system cannot process the request for this site <i>&lt;URL&gt;</i> . A non-standard browser may have generated an invalid HTTP request.  If using a standard browser, please retry the request.
ERR_FILE_SIZE Policy: File Size	Block page that is displayed when the requested file is larger than the allowed maximum file size.	Based on your organization's Access Policies, access to this web site or download <i>&lt;URL&gt;</i> has been blocked because the download size exceeds the allowed limit.
ERR_FILE_TYPE Policy: File Type	Block page that is displayed when the requested file is a blocked file type.	Based on your organization's Access Policies, access to this web site or download <i>&lt;URL&gt;</i> has been blocked because the file type " <i>&lt;file type&gt;</i> " is not allowed.
ERR_FILTER_FAILURE Filter Failure	Error page that is displayed when the URL filtering engine is temporarily unable to deliver a URL filtering response and the "Default Action for Unreachable Service" option is set to Block.	The request for page <i>&lt;URL&gt;</i> has been denied because an internal server is currently unreachable or overloaded.  Please retry the request later.
ERR_FOUND Found	Internal redirection page for some errors.	The page <i>&lt;URL&gt;</i> is being redirected to <i>&lt;redirected URL&gt;</i> .
ERR_FTP_ABORTED FTP Aborted	Error page that is displayed when the FTP over HTTP transaction request triggers the HTTP 416 "Requested Range Not Satisfiable" response.	The request for the file <i>&lt;URL&gt;</i> did not succeed. The FTP server <i>&lt;hostname&gt;</i> unexpectedly terminated the connection.  Please retry the request later.

Table 16-6 Notification Page Types (continued)

File Name and Notification Title	Notification Description	Notification Text
ERR_FTP_AUTH_REQUI RED FTP Authorization Required	Error page that is displayed when the FTP over HTTP transaction request triggers the FTP 530 “Not Logged In” response.	Authentication is required by the FTP server <hostname>. A valid user ID and password must be entered when prompted.  In some cases, the FTP server may limit the number of anonymous connections. If you usually connect to this server as an anonymous user, please try again later.
ERR_FTP_CONNECTION _FAILED FTP Connection Failed	Error page that is displayed when the FTP over HTTP transaction request triggers the FTP 425 “Can’t open data connection” response.	The system cannot communicate with the FTP server <hostname>. The FTP server may be temporarily or permanently down, or may be unreachable because of network problems.  Please check the spelling of the address entered. If it is correct, try this request later.
ERR_FTP_FORBIDDEN FTP Forbidden	Error page that is displayed when the FTP over HTTP transaction request is for an object the user is not allowed to access.	Access was denied by the FTP server <hostname>. Your user ID does not have permission to access this document.
ERR_FTP_NOT_FOUND FTP Not Found	Error page that is displayed when the FTP over HTTP transaction request is for an object that does not exist on the server.	The file <URL> could not be found. The address is either incorrect or obsolete.
ERR_FTP_SERVER_ERR FTP Server Error	Error page that is displayed for FTP over HTTP transactions that try to access a server that does support FTP. The server usually returns the HTTP 501 “Not Implemented” response.	The system cannot communicate with the FTP server <hostname>. The FTP server may be temporarily or permanently down, or may not provide this service.  Please confirm that this is a valid address. If it is correct, try this request later.
ERR_FTP_SERVICE_UN AVAIL FTP Service Unavailable	Error page that is displayed for FTP over HTTP transactions that try to access an FTP server that is unavailable.	The system cannot communicate with the FTP server <hostname>. The FTP server may be busy, may be permanently down, or may not provide this service.  Please confirm that this is a valid address. If it is correct, try this request later.
ERR_GATEWAY_TIMEO UT Gateway Timeout	Error page that is displayed when the requested server has not responded in a timely manner.	The system cannot communicate with the external server <hostname>. The Internet server may be busy, may be permanently down, or may be unreachable because of network problems.  Please check the spelling of the Internet address entered. If it is correct, try this request later.
ERR_IDS_ACCESS_FOR BIDDEN IDS Access Forbidden	Block page that is displayed when the user tries to upload a file that is blocked due to a configured Cisco IronPort Data Security Policy.	Based on your organization’s data transfer policies, your upload request has been blocked. File details:  <file details>

Table 16-6 Notification Page Types (continued)

File Name and Notification Title	Notification Description	Notification Text
ERR_INTERNAL_ERROR Internal Error	Error page that is displayed when there is an internal error.	Internal system error when processing the request for the page <URL>. Please retry this request. If this condition persists, please contact <contact name> <email address> and provide the code shown below.
ERR_MALWARE_SPECIFIC Security: Malware Detected	Block page that is displayed when malware is detected when downloading a file.	Based on your organization's Access Policies, this web site <URL> has been blocked because it has been determined to be a security threat to your computer or the organization's network. Malware <malware name> in the category <malware category> has been found on this site.
ERR_MALWARE_SPECIFIC_OUTGOING Security: Malware Detected	Block page that is displayed when malware is detected when uploading a file.	Based on your organization's policy, the upload of the file to URL (<URL>) has been blocked because the file was detected to contain malware that will be harmful to the receiving end's network security. Malware Name: <malware name> Malware Category: <malware category>
ERR_NATIVE_FTP_DENIED	Block message displayed in native FTP clients when the native FTP transaction is blocked.	530 Login denied
ERR_NO_MORE_FORWARDS No More Forwards	Error page that is displayed when the appliance has detected a forward loop between the Web Proxy and another proxy server on the network. The Web Proxy breaks the loop and displays this message to the client.	The request for the page <URL> failed. The server address <hostname> may be invalid, or you may need to specify a port number to access this server.
ERR_POLICY Policy: General	Block page that is displayed when the request is blocked by any policy setting.	Based on your organization's Access Policies, access to this web site <URL> has been blocked.
ERR_PROTOCOL Policy: Protocol	Block page that is displayed when the request is blocked based on the protocol used.	Based on your organization's Access Policies, this request has been blocked because the data transfer protocol "<protocol type>" is not allowed.
ERR_PROXY_AUTH_REQUIRED Proxy Authorization Required	Notification page that is displayed when users must enter their authentication credentials to continue. This is used for explicit transaction requests.	Authentication is required to access the Internet using this system. A valid user ID and password must be entered when prompted.

Table 16-6 Notification Page Types (continued)

File Name and Notification Title	Notification Description	Notification Text
ERR_PROXY_PREVENT_MULTIPLE_LOGIN Already Logged In From Another Machine	Block page that is displayed when someone tries to access the web using the same username that is already authenticated with the Web Proxy on a different machine. This is used when the User Session Restrictions global authentication option is enabled.	Based on your organization's policies, the request to access the Internet was denied because this user ID has an active session from another IP address.  If you want to login as a different user, click on the button below and enter a different a user name and password.
ERR_PROXY_REDIRECT Redirect	Redirection page.	This request is being redirected. If this page does not automatically redirect, click here to proceed.
ERR_PROXY_UNACKNOWLEDGED Policy Acknowledgement	End-user acknowledgement page. For more information, see <a href="#">End-User Acknowledgement Page, page 16-11</a> .	Please acknowledge the following statements before accessing the Internet.  Your web transactions will be automatically monitored and processed to detect dangerous content and to enforce organization's policies. By clicking the link below, you acknowledge this monitoring and accept that data about the sites you visit may be recorded. You will be periodically asked to acknowledge the presence of the monitoring system. You are responsible for following organization's policies on Internet access.  Click here to accept this statement and access the Internet.
ERR_PROXY_UNLICENSED Proxy Not Licensed	Block page that is displayed when there is no valid license key for the Web Security appliance Web Proxy.	Internet access is not available without proper licensing of the security device.  Please contact <contact name> <email address> and provide the code shown below.  <b>Note</b> To access the management interface of the security device, enter the configured IP address with port.
ERR_RANGE_NOT_SATISFIABLE Range Not Satisfiable	Error page that is displayed when the requested range of bytes cannot be satisfied by the web server.	The system cannot process this request. A non-standard browser may have generated an invalid HTTP request.  If you are using a standard browser, please retry the request.
ERR_REDIRECT_PERMANENT Redirect Permanent	Internal redirection page.	The page <URL> is being redirected to <redirected URL>.
ERR_REDIRECT_REPEAT_REQUEST Redirect	Internal redirection page.	Please repeat your request.

Table 16-6 Notification Page Types (continued)

File Name and Notification Title	Notification Description	Notification Text
ERR_SAAS_AUTHENTIC ATION SaaS Policy: Access Denied	Notification page that is displayed when users must enter their authentication credentials to continue. This is used for accessing SaaS applications.	Based on your organization's policy, the request to access <URL> was redirected to a page where you must enter the login credentials. You will be allowed to access the application if authentication succeeds and you have the proper privileges.
ERR_SAAS_AUTHORIZ ATION SaaS Policy: Access Denied	Block page that is displayed when users try to access a SaaS application that they have no privilege to access.	Based on your organization's policy, the access to the SaaS application <URL> is blocked because you are not an authorized user. If you want to login as a different user, enter a different username and password for a user that is authorized to access this application.
ERR_SAML_PROCESSIN G SaaS Policy: Access Denied	Error page that is displayed when an internal process fails trying to process the single sign-on URL for accessing a SaaS application.	The request to access <user name> did not go through because errors were found during the process of the single sign on request.
ERR_SERVER_NAME_E XPANSION Server Name Expansion	Internal redirection page that automatically expands the URL and redirects users to the updated URL.	The server name <hostname> appears to be an abbreviation, and is being redirected to <redirected URL>.
ERR_URI_TOO_LONG URI Too Long	Block page that is displayed when the URL length is too long.	The requested URL was too long and could not be processed. This may represent an attack on your network.  Please contact <contact name> <email address> and provide the code shown below.
ERR_WBRS Security: Malware Risk	Block page that is displayed when the Web Reputation Filters block the site due to a low web reputation score.	Based on your organization's access policies, this web site <URL> has been blocked because it has been determined by Web Reputation Filters to be a security threat to your computer or the organization's network. This web site has been associated with malware/spyware.  Threat Type: %o Threat Reason: %O
ERR_WEBCAT Policy: URL Filtering	Block page that is displayed when users try to access a website in a blocked URL category.	Based on your organization's Access Policies, access to this web site <URL> has been blocked because the web category "<category type>" is not allowed.
ERR_WWW_AUTH_REQ UIRED WWW Authorization Required	Notification page that is displayed when the requested server requires users to enter their credentials to continue.	Authentication is required to access the requested web site <hostname>. A valid user ID and password must be entered when prompted.

# 17

## URL Filters

---

- [URL Filters Overview, page 17-1](#)
- [Configuring the URL Filtering Engine, page 17-4](#)
- [Managing Updates to the Set of URL Categories, page 17-4](#)
- [Filtering Transactions Using URL Categories, page 17-9](#)
- [Creating and Editing Custom URL Categories, page 17-15](#)
- [Filtering Adult Content, page 17-17](#)
- [Redirecting Traffic, page 17-19](#)
- [Warning Users and Allowing Them to Continue, page 17-20](#)
- [Creating Time Based URL Filters, page 17-21](#)
- [Viewing URL Filtering Activity, page 17-22](#)
- [Regular Expressions, page 17-23](#)
- [URL Category Descriptions, page 17-25](#)

## URL Filters Overview

AsyncOS for Web allows administrators to control user access based on the web server category of a particular HTTP or HTTPS request. For example, you can block all HTTP requests for gambling web sites, or you can decrypt all HTTPS requests for web-based email websites.

Using policy groups, you can create secure policies that control access to web sites containing objectionable or questionable content. The sites that are actually blocked, dropped, allowed, or decrypted depend on the categories you select when setting up category blocking for each policy group.

To control user access based on a URL category, you must enable Cisco IronPort Web Usage Controls. This is a multi-layered URL filtering engine that uses domain prefixes and keyword analysis to categorize URLs, and real-time response content analysis using the Dynamic Content Analysis engine if no category is determined by prefixes and keywords. It includes over 80 predefined URL categories. This engine also allows end users and administrators to report to Cisco any miscategorized URLs as well as uncategorized URLs for future inclusion in the categorization database. For more information, see [Dynamic Content Analysis Engine, page 17-2](#).

You can use URL categories when performing the following tasks:

- **Define policy group membership.** You can define policy group membership by the URL category of the request URL.

- **Control access to HTTP, HTTPS, and FTP requests.** You can choose to allow or block HTTP and FTP requests by URL category using Access Policies, and you can choose to pass through, drop, or decrypt HTTPS requests by URL category using Decryption Policies. You can also choose whether or not to block upload requests by URL category using Cisco IronPort Data Security Policies. For more information, see [Filtering Transactions Using URL Categories, page 17-9](#).

In addition to the predefined URL categories included with the URL filtering engine, you can create user defined custom URL categories that specify specific hostnames and IP addresses. For more information, see [Creating and Editing Custom URL Categories, page 17-15](#).

## Dynamic Content Analysis Engine

The Dynamic Content Analysis engine is a scanning engine called at response time to categorize a transaction that failed categorization using only the URL in the client request. You might want to enable Dynamic Content Analysis when your organization's traffic visits more of the newer, and therefore not yet categorized, sites on the Internet.

Enable the Dynamic Content Analysis engine when you enable Cisco IronPort Web Usage Controls on the Security Services > Acceptable Use Controls page.

After the Dynamic Content Analysis engine categorizes a URL, it stores the category verdict and URL in a temporary cache. This allows future transactions to benefit from the earlier response scan and be categorized at request time instead of at response time, and it improves overall performance.

The Dynamic Content Analysis engine categorizes URLs when controlling access to websites in Access Policies only. It does not categorize URLs when determining policy group membership or when controlling access to websites using Decryption or Cisco IronPort Data Security Policies. This is because the engine works by analyzing the response content from the destination server, so it cannot be used on decisions that must be made at request time before any response is downloaded from the server.

Enabling the Dynamic Content Analysis engine can impact transaction performance. However, most transactions are categorized using the Cisco IronPort Web Usage Controls URL categories database, so the Dynamic Content Analysis engine is usually only called for a small percentage of transactions.



### Note

---

It is possible for an Access Policy, or an Identity used in an Access Policy, to define policy membership by a predefined URL category and for the Access Policy to perform an action on the same URL category. In this case, it is also possible for the URL in the request to be uncategorized when determining Identity and Access Policy group membership, but to be categorized by the Dynamic Content Analysis engine after receiving the server response. In this scenario, Cisco IronPort Web Usage Controls ignores the category verdict from the Dynamic Content Analysis engine and the URL retains the “uncategorized” verdict for the remainder of the transaction. However, future transactions still benefit from the new category verdict.

---

## Uncategorized URLs

An uncategorized URL is a URL that does not match any pre-defined URL category or *included* custom URL category.



### Note

---

When determining policy group membership, a custom URL category is considered included only when it is selected for policy group membership.

---



All transactions resulting in unmatched categories are reported on the Reporting > URL Categories page as “Uncategorized URLs.” A large number of uncategorized URLs are generated from requests to web sites within the internal network. Because this type of internal transaction can falsely inflate reporting data and misrepresent the efficacy of the URL filtering engine, Cisco recommends using custom URL categories to group internal URLs and allow all requests to internal web sites. This decreases the number of web transactions reported as “Uncategorized URLs” and instead reports internal transactions as part of “URL Filtering Bypassed” statistics.

For more information, see [Understanding Unfiltered and Uncategorized Data, page 17-22](#).

For more information about creating custom URL categories, see [Creating and Editing Custom URL Categories, page 17-15](#).

## Matching URLs to URL Categories

When the URL filtering engine matches a URL category to the URL in a client request, it first evaluates the URL against the custom URL categories *included* in the policy group. If the URL in the request does not match an included custom category, the URL filtering engine compares it to the predefined URL categories. If the URL does not match any included custom or predefined URL categories, the request is uncategorized.



### Note

When determining policy group membership, a custom URL category is considered included only when it is selected for policy group membership.



### Tip

To see what category a particular web site is assigned to, go to the URL in [Reporting Uncategorized and Misclassified URLs, page 17-3](#).

For more information about uncategorized URLs, see [Uncategorized URLs, page 17-2](#).

## Reporting Uncategorized and Misclassified URLs

When you use Cisco IronPort Web Usage Controls, you can report uncategorized and misclassified URLs to Cisco. Cisco provides a URL submission tool on its website that allows you to submit multiple URLs simultaneously:

```
https://securityhub.cisco.com/web/submit_urls
```

To check the status of submitted URLs, click the Status on Submitted URLs tab on this page.

You can also use the URL submission tool to look up the assigned URL category for any URL.

## The URL Categories Database

The category that a URL falls into is determined by a filtering categories database. The Web Security appliance collects information and maintains a separate database for each URL filtering engine. The filtering categories databases periodically receive updates from the Cisco IronPort update server (<https://update-manifests.ironport.com>). Server updates are automated, and the update interval is set by the server as opposed to the appliance. Updates to the database occur regularly, and require no administrator intervention.

Cisco IronPort Web Usage Controls shares some database components with the Web Reputation Filters (WBRF) database. Because of this shared information, Cisco recommends fully participating in the SensorBase Network because it allows Cisco IronPort Web Usage Controls to validate and categorize all URLs dynamically classified by the Dynamic Content Analysis engine, including all URLs that could not otherwise be classified, improving overall efficacy.

For information about update intervals and the Cisco IronPort update server, see [Manually Updating Security Service Components, page 26-41](#).

The URL categories database includes many different factors and sources of data internal to Cisco and from the Internet. One of the factors occasionally considered, heavily modified from the original, is information from the Open Directory Project.

Help build the largest human-edited directory on the web.  
[Submit a Site](#) - [Open Directory Project](#) - [Become an Editor](#)



Tip

To see what category a particular web site is assigned to, go to the URL in [Reporting Uncategorized and Misclassified URLs, page 17-3](#).

## Configuring the URL Filtering Engine

To apply predefined category settings to policy groups and configure custom settings to manage web transactions, see the sections below. By default, the Cisco IronPort Web Usage Controls URL filtering engine is enabled in the System Setup Wizard.

**Step 1** Navigate to the **Security Services > Acceptable Use Controls** page.

**Step 2** Click **Edit Global Settings**.

**Step 3** Verify the Enable Acceptable Use Controls property is enabled.



**Note** For information about the Application Visibility and Control setting, see [Chapter 18, “Understanding Application Visibility and Control.”](#)

**Step 4** Choose whether or not to enable the Dynamic Content Analysis Engine.

For more information on the Dynamic Content Analysis Engine, see [Dynamic Content Analysis Engine, page 17-2](#).

**Step 5** Choose the default action the Web Proxy should use when the URL filtering engine is unavailable, either Monitor or Block. Default is Monitor.

**Step 6** Submit and commit your changes.

## Managing Updates to the Set of URL Categories

The set of predefined URL categories for Cisco IronPort Web Usage Control may occasionally be updated, in order to accommodate new web trends and evolving usage patterns.

Updates to the URL category set are distinct from the changes that simply add new URLs and re-map misclassified URLs, as described in [The URL Categories Database, page 17-3](#). Category set updates may change configurations in your existing policies and therefore require action from you.

URL category set updates may occur between product releases; an AsyncOS upgrade is not required. Information about each update will be available from [http://www.cisco.com/en/US/products/ps10164/prod\\_release\\_notes\\_list.html](http://www.cisco.com/en/US/products/ps10164/prod_release_notes_list.html).

You should take the following actions:

When to Act	For Information, Review This Section
Before updates occur (Do these tasks as part of your initial setup)	<ul style="list-style-type: none"> <li>• <a href="#">Understanding the Impacts of URL Category Set Updates, page 17-5</a></li> <li>• <a href="#">Controlling Updates to the URL Category Set, page 17-8</a></li> <li>• <a href="#">Choosing Default Settings for New and Changed Categories, page 17-9</a></li> <li>• <a href="#">Ensuring that You Receive Alerts About Category and Policy Changes, page 17-9</a></li> </ul>
After updates occur	<ul style="list-style-type: none"> <li>• <a href="#">Responding to Alerts about URL Category Set Updates, page 17-9</a></li> <li>• <a href="#">URL Category Set Updates and Reports, page 23-12</a> This section describes how URL category set changes impact reporting and web tracking data.</li> <li>• Policy changes resulting from URL category set updates are logged in the GUI logs. See the Logging chapter for more information.</li> </ul>

## Understanding the Impacts of URL Category Set Updates

URL category set updates can have the following impacts on existing Access Policies, Decryption Policies, and Cisco IronPort Data Security policies, and on Identities:

- [Effects of URL Category Set Changes on Policy Group Membership, page 17-5](#)
- [Effects of URL Category Set Updates on Filtering Actions in Policies, page 17-6](#)

### Effects of URL Category Set Changes on Policy Group Membership

This section applies to all policy types with membership that can be defined by URL category, and to Identities.

When policy group membership is defined by URL category, changes to the category set may have the following effects:

- If the sole criterion for membership is a deleted category, the policy or identity is disabled.
- If membership in any policy is defined by a URL category that changes, and if this causes ACL list changes, the web proxy will restart. For the effects of proxy restarts, see [Checking for Web Proxy Restart on Commit, page 2-10](#).

## Effects of URL Category Set Updates on Filtering Actions in Policies

URL category set updates can change policy behavior in the following ways:

**Table 17-1** *Effects of URL Category Set Updates*

<b>Change</b>	<b>Effect on Policies and Identities</b>
A new category can be added	For each policy, the default action for newly-added categories is the action specified for Uncategorized URLs for that policy.
A category can be deleted	The action associated with the deleted category is deleted. If the policy depended exclusively on the deleted category, the policy is disabled. If a policy depends on an identity that depended exclusively on a deleted category, the policy will be disabled.
A category can be renamed	No change to the behavior of the existing policy.
A category can split	A single category can become multiple new categories. For example, a single “Arts and Entertainment” category might become two categories, “Arts” and “Entertainment”. Both new categories have the action associated with the original category.

**Table 17-1** *Effects of URL Category Set Updates*

Change	Effect on Policies and Identities
Two or more existing categories can merge	<p>If all original categories in a policy had the same action assigned, the merged category has the same action as the original categories. If all original categories were set to “Use Global Setting” then the merged category is also set to “Use Global Setting.”</p> <p>If the policy had different actions assigned to the original categories, the action assigned to the merged category depends on the Uncategorized URLs setting in that policy:</p> <ul style="list-style-type: none"> <li>• If Uncategorized URLs is set to Block (or “Use Global Setting” when the global setting is Block), then the most restrictive action among the original categories is applied to the merged category.</li> <li>• If Uncategorized URLs is set to any action other than Block (or “Use Global Setting” when the global setting is anything other than Block), then the least restrictive action among the original categories is applied to the merged category.</li> </ul> <p>In this case, sites that were previously blocked may now be accessible to users.</p> <p>If policy membership is defined by URL category, and some of the categories involved in the merge, or the Uncategorized URLs action, are not included in the policy membership definition, then the values in the Global Policy are used for the missing items.</p> <p>The order of restrictiveness is as follows (not all actions are available for all policy types):</p> <ul style="list-style-type: none"> <li>• Block</li> <li>• Drop</li> <li>• Decrypt</li> <li>• Warn</li> <li>• Time-based</li> <li>• Monitor</li> <li>• Pass Through</li> </ul> <p>For more information, see <a href="#">Merged Categories - Examples, page 17-7</a>.</p> <p>Note: Time-based policies that are based on merged categories adopt the action associated with any one of the original categories. (In time-based policies, there may be no obviously most- or least-restrictive action.)</p>

## Merged Categories - Examples

Some examples of merged categories, based on settings on the URL Filtering page for the policy:

**Table 17-2** *Example Outcomes When Categories Merge*

Original Category 1	Original Category 2	Uncategorized URLs	Merged Category
Monitor	Monitor	(Not Applicable)	Monitor
Block	Block	(Not Applicable)	Block
Use Global Settings	Use Global Settings	(Not Applicable)	Use Global Settings

Table 17-2 Example Outcomes When Categories Merge

Original Category 1	Original Category 2	Uncategorized URLs	Merged Category
Warn	Block	Monitor Thus, use the least restrictive among the original categories.	Warn
Monitor	<ul style="list-style-type: none"> <li>Block or</li> <li>Use Global Settings, when Global is set to Block</li> </ul>	<ul style="list-style-type: none"> <li>Block or</li> <li>Use Global Setting, when Global is set to Block</li> </ul> Thus, use the most restrictive among the original categories.	Block
Block	<ul style="list-style-type: none"> <li>Monitor or</li> <li>Use Global Settings, when Global is set to Monitor</li> </ul>	<ul style="list-style-type: none"> <li>Monitor or</li> <li>Use Global Setting, when Global is set to Monitor</li> </ul> Thus, use the least restrictive among the original categories.	Monitor
For policies in which membership is defined by URL category: Monitor	An action for this category is not specified in this policy, but the value in the Global Policy for this category is Block	An action for Uncategorized URLs is not specified in this policy, but the value in the Global Policy for Uncategorized URLs is Monitor	Monitor

## Controlling Updates to the URL Category Set

By default, URL category set updates occur automatically. However, because these updates may change existing policy configurations, you may prefer to disable all automatic updates, including URL category set updates.

If you disable updates, you will need to manually update all services listed in the Update Servers (list) section of the System Administration > Upgrade and Update Settings page. See [Manually Updating the URL Category Set, page 17-8](#) and [Manually Updating Security Service Components, page 26-41](#).

To disable all automatic updates, see [Configuring the Update and Upgrade Settings from the Web Interface, page 26-39](#) or [Configuring the Update and Upgrade Settings from the CLI, page 26-41](#). If you use the CLI, disable updates by setting the update interval to zero (0).

## Manually Updating the URL Category Set



**Note** Do not interrupt an update in progress.

If you have disabled automatic updates, you can manually update the set of URL categories at your convenience.

**Step 1** Navigate to the **Security Services > Acceptable Use Controls** page.

**Step 2** Determine whether an update is available:

Look at the “Cisco IronPort Web Usage Controls - Web Categorization Categories List” item in the Acceptable Use Controls Engine Updates table.

**Step 3** To update, click **Update Now**.

---

## Choosing Default Settings for New and Changed Categories

URL category set updates may change the behavior of your existing policies. You should specify default settings for certain changes when you configure your policies, so that they are ready when URL category set updates occur.

When new categories are added, or existing categories merge into a new category, the default action for these categories for each policy are affected by the Uncategorized URLs setting in that policy. To choose settings that will meet your needs, review the information for new and merged categories in the [“Effects of URL Category Set Updates on Filtering Actions in Policies”](#) section on page 17-6.

To verify existing settings and/or make changes, click the URL Filtering link for each Access Policy, Decryption Policy, and Cisco IronPort Data Security policy, and check the selected setting for Uncategorized URLs.

## Ensuring that You Receive Alerts About Category and Policy Changes

Category set updates trigger two types of alerts: Alerts about category changes and alerts about policies that have changed or been disabled as a result of category set changes.

To verify that you will receive alerts about URL category set updates, go to System Administration > Alerts and make sure you will receive Warning-level alerts in the System category. More information about alerts is in [Managing Alerts, page 26-17](#).

## Responding to Alerts about URL Category Set Updates

When you receive an alert about category set changes, you should do the following:

- Check policies and identities to be sure that they still meet your policy goals after category merges, additions, and deletions, and
- Consider modifying policies and identities to benefit from new categories and the added granularity of split categories.

Use the information in [Understanding the Impacts of URL Category Set Updates, page 17-5](#) to guide your review of your policies and identities.

## Filtering Transactions Using URL Categories

The URL filtering engine configured allows you to filter transactions in Access, Decryption, and Data Security Policies. To configure URL filtering in a policy group, click the link in the policies table under the URL Categories column for the policy group you want to edit. For more information about the policies table, see [Using the Policies Tables, page 7-5](#).

When you configure URL categories for policy groups, you can configure actions for custom URL categories, if any are defined, and predefined URL categories. For more information about custom URL categories, see [Creating and Editing Custom URL Categories, page 17-15](#).

The URL filtering actions you can configure depends on the type of policy group.

- **Access Policies.** See [Configuring URL Filters for Access Policy Groups, page 17-10](#).
- **Decryption Policies.** See [Configuring URL Filters for Decryption Policy Groups, page 17-12](#).
- **Cisco IronPort Data Security Policies.** See [Configuring URL Filters for Data Security Policy Groups, page 17-13](#).







## Configuring URL Filters for Access Policy Groups

You can configure URL filtering for user defined Access Policy groups and the Global Policy Group.

- Step 1** Navigate to the Web Security Manager > Access Policies page.
- Step 2** Click the link in the policies table under the URL Filtering column for the policy group you want to edit.
- Step 3** Optionally, in the Custom URL Category Filtering section, you can add custom URL categories on which to take action in this policy:
- Click **Select Custom Categories**.
  - Choose which custom URL categories to include in this policy and click **Apply**.

Choose which custom URL categories the URL filtering engine should compare the client request against. The URL filtering engine compares client requests against included custom URL categories, and ignores excluded custom URL categories. The URL filtering engine compares the URL in a client request to included custom URL categories before predefined URL categories.

The custom URL categories included in the policy appear in the Custom URL Category Filtering section.

Custom URL Category Filtering							
<i>These URL Categories are defined as group membership criteria. All other categories are not applicable for this policy.</i>							
	Use Global Settings	Override Global Settings					
		Redirect 	Allow 	Monitor 	Warn 	Block 	Time-Based 
	Select all	Select all	Select all	Select all	Select all	Select all	(Unavailable)
 partners	–			<input checked="" type="checkbox"/>			–
<a href="#">Select Custom Categories...</a>							



**Step 4** In the Custom URL Category Filtering section, choose an action for each included custom URL category. [Table 17-3](#) describes each action.

**Table 17-3** *URL Category Filtering for Access Policies*

Action	Description
Use Global Setting	<p>Uses the action for this category in the Global Policy Group. This is the default action for user defined policy groups.</p> <p>Applies to user defined policy groups only.</p> <p><b>Note:</b> When a custom URL category is excluded in the global Access Policy, then the default action for included custom URL categories in user defined Access Policies is Monitor instead of Use Global Settings. You cannot choose Use Global Settings when a custom URL category is excluded in the global Access Policy.</p>
Redirect	<p>Redirects traffic originally destined for a URL in this category to a location you specify. When you choose this action, the Redirect To field appears. Enter a URL to which to redirect all traffic.</p> <p>For more information about redirecting traffic, see <a href="#">Redirecting Traffic, page 17-19</a>.</p>
Allow	<p>Always allows client requests for web sites in this category.</p> <p>Allowed requests bypass all further filtering and malware scanning.</p> <p>Only use this setting for trusted web sites. You might want to use this setting for internal sites.</p>
Monitor	<p>The Web Proxy neither allows nor blocks the request. Instead, it continues to evaluate the client request against other policy group control settings, such as web reputation filtering.</p>
Warn	<p>The Web Proxy initially blocks the request and displays a warning page, but allows the user to continue by clicking a hypertext link in the warning page.</p> <p>For more information, see <a href="#">Warning Users and Allowing Them to Continue, page 17-20</a>.</p>
Block	<p>The Web Proxy denies transactions that match this setting.</p>
Time-Based	<p>The Web Proxy blocks or monitors the request during the time ranges you specify.</p> <p>For more information about creating time based URL filtering actions, see <a href="#">Creating Time Based URL Filters, page 17-21</a>.</p>

**Step 5** In the Predefined URL Category Filtering section, choose one of the following actions for each category:

- Use Global Settings
- Monitor
- Warn
- Block
- Time-Based

See [Table 17-3](#) for details on these actions.

**Step 6** In the Uncategorized URLs section, choose the action to take for client requests to web sites that do not fall into a predefined or custom URL category. This setting also determines the default action for new and merged categories resulting from URL category set updates. For details, see [Effects of URL Category Set Updates on Filtering Actions in Policies, page 17-6](#).

**Step 7** Submit and commit your changes.

## Configuring URL Filters for Decryption Policy Groups

You can configure URL filtering for user defined Decryption Policy groups and the global Decryption Policy group.

**Step 1** Navigate to the Web Security Manager > Decryption Policies page.

**Step 2** Click the link in the policies table under the URL Categories column for the policy group you want to edit.

**Step 3** Optionally, in the Custom URL Category Filtering section, you can add custom URL categories on which to take action in this policy:

- a. Click **Select Custom Categories**.
- b. Choose which custom URL categories to include in this policy and click **Apply**.

Choose which custom URL categories the URL filtering engine should compare the client request against. The URL filtering engine compares client requests against included custom URL categories, and ignores excluded custom URL categories. The URL filtering engine compares the URL in a client request to included custom URL categories before predefined URL categories.

The custom URL categories included in the policy appear in the Custom URL Category Filtering section.

Custom URL Category Filtering						
<i>These URL Categories are defined as group membership criteria. All other categories are not applicable for this policy.</i>						
	Use Global Settings	Override Global Settings				
		Pass Through	Monitor	Decrypt	Drop	Time-Based
	Select all	Select all	Select all	Select all	Select all	(Unavailable)
partners	—		<input checked="" type="checkbox"/>			—
<a href="#">Select Custom Categories...</a>						

**Step 4** Choose an action for each custom and predefined URL category. [Table 17-4](#) describes each action.

**Table 17-4** URL Category Filtering for Decryption Policies

Action	Description
Use Global Setting	Uses the action for this category in the global Decryption Policy group. This is the default action for user defined policy groups.  Applies to user defined policy groups only.  When a custom URL category is excluded in the global Decryption Policy, then the default action for included custom URL categories in user defined Decryption Policies is Monitor instead of Use Global Settings. You cannot choose Use Global Settings when a custom URL category is excluded in the global Decryption Policy.
Pass Through	Passes through the connection between the client and the server without inspecting the traffic content. You might want to pass through connections to trusted secure sites, such as well known banking and financial institutions.
Monitor	The Web Proxy neither allows nor blocks the request. Instead, it continues to evaluate the client request against other policy group control settings, such as web reputation filtering.

**Table 17-4** URL Category Filtering for Decryption Policies (continued)

Action	Description
Decrypt	Allows the connection, but inspects the traffic content. The appliance decrypts the traffic and applies Access Policies to the decrypted traffic as if it were a plaintext HTTP connection. By decrypting the connection and applying Access Policies, you can scan the traffic for malware. You might want to decrypt connections to third party email providers, such as gmail or hotmail.  For more information about how the appliance decrypts HTTPS traffic, see <a href="#">Certificates, page 11-3</a> .
Drop	Drops the connection and does not pass the connection request to the server. The appliance does not notify the user that it dropped the connection. You might want to drop connections to third party proxies that allow users on the network bypass the organization's acceptable use policies.



**Note** If you want to *block* a particular URL category for HTTPS requests, choose to decrypt that URL category in the Decryption Policy group and then choose to block the same URL category in the Access Policy group.

**Step 5** In the Uncategorized URLs section, choose the action to take for client requests to web sites that do not fall into a predefined or custom URL category.

This setting also determines the default action for new and merged categories resulting from URL category set updates. For details, see [Effects of URL Category Set Updates on Filtering Actions in Policies, page 17-6](#).

You can choose any action listed in [Table 17-4](#).

**Step 6** Submit and commit your changes.

## Configuring URL Filters for Data Security Policy Groups

You can configure URL filtering for user defined Data Security Policy groups and the Global Policy Group.

**Step 1** Navigate to the Web Security Manager > Cisco IronPort Data Security page.

**Step 2** Click the link in the policies table under the URL Categories column for the policy group you want to edit.

**Step 3** Optionally, in the Custom URL Category Filtering section, you can add custom URL categories on which to take action in this policy:

- a. Click **Select Custom Categories**.
- b. Choose which custom URL categories to include in this policy and click **Apply**.

Choose which custom URL categories the URL filtering engine should compare the client request against. The URL filtering engine compares client requests against included custom URL categories, and ignores excluded custom URL categories. The URL filtering engine compares the URL in a client request to included custom URL categories before predefined URL categories.

The custom URL categories included in the policy appear in the Custom URL Category Filtering section.

Custom URL Category Filtering				
<i>These URL Categories are defined as group membership criteria. All other categories are not applicable for this policy.</i>				
	Use Global Settings	Override Global Settings		
		Allow ?	Monitor	Block
	Select all	Select all	Select all	Select all
partners	-		✓	
Select Custom Categories...				

**Step 4** In the Custom URL Category Filtering section, choose an action for each custom URL category. [Table 17-5](#) describes each action.

**Table 17-5** URL Category Filtering for Cisco IronPort Data Security Policies

Action	Description
Use Global Setting	<p>Uses the action for this category in the Global Policy Group. This is the default action for user defined policy groups.</p> <p>Applies to user defined policy groups only.</p> <p>When a custom URL category is excluded in the global Cisco IronPort Data Security Policy, then the default action for included custom URL categories in user defined Cisco IronPort Data Security Policies is Monitor instead of Use Global Settings. You cannot choose Use Global Settings when a custom URL category is excluded in the global Cisco IronPort Data Security Policy.</p>
Allow	<p>Always allows upload requests for web sites in this category. Applies to custom URL categories only.</p> <p>Allowed requests bypass all further data security scanning and the request is evaluated against Access Policies.</p> <p>Only use this setting for trusted web sites. You might want to use this setting for internal sites.</p>
Monitor	The Web Proxy neither allows nor blocks the request. Instead, it continues to evaluate the upload request against other policy group control settings, such as web reputation filtering.
Block	The Web Proxy denies transactions that match this setting.

**Step 5** In the Predefined URL Category Filtering section, choose one of the following actions for each category:

- Use Global Settings
- Monitor
- Block

See [Table 17-5](#) for details on these actions.

**Step 6** In the Uncategorized URLs section, choose the action to take for upload requests to web sites that do not fall into a predefined or custom URL category. This setting also determines the default action for new and merged categories resulting from URL category set updates. For details, see [Effects of URL Category Set Updates on Filtering Actions in Policies](#), page 17-6.

**Step 7** Submit and commit your changes.

## Creating and Editing Custom URL Categories

The Web Security appliance ships with many predefined URL categories by default, such as Web-based Email and more. However, you can also create user defined custom URL categories that specify specific hostnames and IP addresses. You might want to create custom URL categories for internal sites or a group of external sites you know you can trust.

Create, edit, and delete custom URL categories on the Web Security Manager > Custom URL Categories page.

**Figure 17-1** Custom URL Categories Page

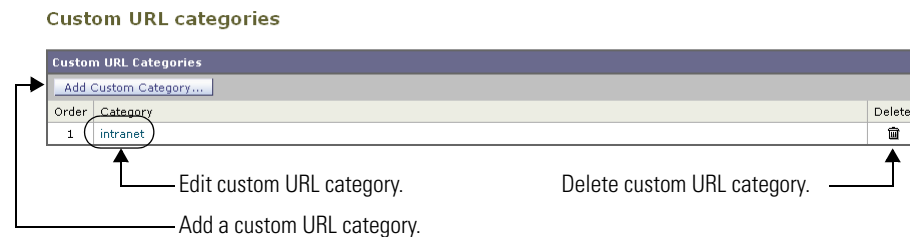

### Note

The Web Security appliance uses the first four characters of custom URL category names preceded by “c\_” in the access logs. Consider the custom URL category name if you use Sawmill for IronPort to parse the access logs. If the first four characters of the custom URL category include a space, Sawmill for IronPort cannot properly parse the access log entry. Instead, only use supported characters in the first four characters if you will use Sawmill for IronPort to parse the access logs. If you want to include the full name of a custom URL category in the access logs, add the %XF format specifier to the access logs. For more information on how to do this, see [Custom Formatting in Access Logs and W3C Logs, page 24-28](#).

It is possible to create multiple custom URL categories and include the same URL in each category. The order of the custom URL categories matters. Categories listed higher in the list take priority over categories listed lower. When you include these custom URL categories in the same Access, Decryption, or Cisco IronPort Data Security Policy group and define different actions to each category, the action of the higher included custom URL category takes effect.

- Step 1** Navigate to the Web Security Manager > Custom URL Categories page.
- Step 2** To create a custom URL category, click **Add Custom Category**. To edit an existing custom URL category, click the name of the URL category.

**Figure 17-2** Creating a Custom URL Category

Custom URL Categories: Add Category

**Step 3** Enter the settings in [Table 17-6](#) for the custom URL category.

**Table 17-6** Custom URL Category Settings

Setting	Description
Category Name	Enter a name for the URL category. This name appears when you configure URL filtering for policy groups.
List Order	Choose the order in the list of custom URL categories to place this category. Enter “1” for the topmost URL category.  The URL filtering engine evaluates a client request against the custom URL categories in the order specified.
Sites	Enter one or more addresses that belong in the custom category.  You can enter multiple addresses separated by line breaks or commas. You can enter addresses using any of the following formats: <ul style="list-style-type: none"> <li>• IP address, such as 10.1.1.0</li> <li>• CIDR address, such as 10.1.1.0/24</li> <li>• Domain name, such as example.com</li> <li>• Hostname, such as crm.example.com</li> <li>• Partial hostname, such as .example.com</li> </ul> <p><b>Note:</b> Entering a partial hostname, such as .example.com, also matches www.example.com.</p>
Advanced: Regular Expressions	You can use regular expressions to specify multiple web servers that match the pattern you enter.  <b>Note:</b> The URL filtering engine compares URLs with addresses entered in the Sites field first. If the URL of a transaction matches an entry in the Sites field, it is not compared to any expression entered here.  For more information about using regular expressions in the Web Security appliance, see <a href="#">Regular Expressions, page 17-23</a> .

**Step 4** Optionally, click **Sort URLs** to sort all addresses in the Sites field.



**Note** Once you sort the addresses, you cannot retrieve their original order.

**Step 5** Submit and commit your changes.

---

## Filtering Adult Content

You can configure the Web Security appliance to filter adult content from some web searches and websites. You might want to do this to allow access to these sites, such as google.com and youtube.com, while still restricting potentially unsafe content from reaching users. For example, a school district could allow access to educational videos on youtube.com, but block inappropriate content for students.

AsyncOS for Web offers the following features to filter adult content:

- **Enforce safe searches.** Many search engines support a filtering technology feature that classifies inappropriate content on the web as adult. When this filtering feature is enabled, content classified as adult is filtered from the search results before presented to the user. This feature is commonly called safe search. However, for most search engines, this feature is enabled and disabled by end users. You can configure the Web Security appliance so that outgoing search requests appear to search engines as safe search requests. This gives the control to an administrator on the network instead of the end user. You might want to do this to prevent users from bypassing acceptable use policies using search engines.
- **Enforce site content ratings.** Many content sharing sites that serve user-generated photos and videos classify some of their content as adult. They allow users to restrict their own access to the adult content on these sites by either enforcing their own safe search feature or blocking access to adult content, or both. This classification feature is commonly called content ratings.

You enforce safe searches and site content ratings for different users by enabling the feature at the Access Policy level. Not all search engines or content sharing websites are supported, but AsyncOS for Web can support additional search engines and websites during URL filtering engine updates. The Access Policies > URL Filtering > *policyname* page always lists the currently supported search engines and websites for each feature. The list of supported search engines and content sharing websites may increase with AVC engine updates.

Consider the following rules and guidelines when enforcing safe search and site content ratings:

- To use the safe search and site content ratings features, AsyncOS for Web must use the URL filtering engine included with Cisco IronPort Web Usage Controls.
- The safe search feature enforces strict safe searches.
- To enforce safe search and site content ratings, the AVC engine takes advantage of the safe mode feature implemented at a particular website by rewriting URLs and/or web cookies to force the safety mode to be on. Therefore, the user experience is determined by the site's functionality. However, in cases where a website does not offer any safe mode functionality, such as craigslist.org, the AVC engine identifies known unsafe sections of the website and blocks or warns about the sites as appropriate.
- When the URL of one of the supported search engines or supported content ratings websites is included in a custom URL category with the Allow action applied, then users can access that URL as if the safe search or content ratings features were disabled. That is, no search results are blocked and all content is visible.
- You can choose whether or not to block users from search engines that are not currently supported by the Web Security appliance safe search feature.
- Due to the limitations inherent in youtube.com, the Web Proxy is not able to block embedded YouTube videos from a third party website.

- When configuring the site content ratings feature, you can choose whether to block users from adult content or to provide them with end-user URL filtering warning page that allows them to view the adult content after clicking a link to accept the warning message. For more information, see [Warning Users and Allowing Them to Continue, page 17-20](#).
- Any Access Policy that has either the safe search or site content ratings feature enabled is considered a safe browsing Access Policy.

## Enforcing Safe Searches and Site Content Ratings:

- 
- Step 1** Navigate to the Web Security Manager > Access Policies page.
- Step 2** Click the link under the URL Categories column for an Access Policy group or the Global Policy Group.
- Step 3** When editing a user-defined Access Policy, choose Define Content Filtering Custom Settings in the Content Filtering section.

**Content Filtering**

Define Content Filtering Custom Settings

**Enable Safe Search**

When Safe Search is enabled, non-safe content, including the cached non-safe content will be blocked from the search result from the following search engines: Bing, Google Search, Yahoo Search. If safe search failed to be enforced on a supported search engine, it will be blocked.

Search engines that don't support safe search  Block  
All search engines other than those that are listed as supporting safe search will be blocked.

**Enable Site Content Rating**

When Site Content Rating is enabled, user access to contents rated as adult oriented or explicit on Flickr, Craigslist, YouTube will be denied. However, the users can still have general access to these websites.

Action if adult or explicit content were attempted from sites that support content rating  Block  Warn

- Step 4** Click the Enable Safe Search check box to enable the safe search feature.
- Step 5** Choose whether to block users from search engines that are not currently supported by the Web Security appliance safe search feature.
- Step 6** Click the Enable Site Content Rating check box to enable the site content ratings feature.
- Step 7** Choose whether to block all adult content from the supported content ratings websites or to display the end-user URL filtering warning page.
- Step 8** Submit and commit your changes.
- 

## Logging Adult Content Access

By default, the access logs include a safe browsing scanning verdict inside the angled brackets of each entry. The safe browsing scanning verdict indicates whether or not either the safe search or site content ratings feature was applied to the transaction. You can also add the safe browsing scanning verdict variable to the access logs or W3C access logs:

- Access logs: %XS
- W3C access logs: x-request-rewrite



Table 17-7 describes the safe browsing scanning verdict values.

**Table 17-7 Safe Browsing Scanning Verdict Values**

Value	Description
ensrch	The original client request was unsafe and the safe search feature was applied.
enrct	The original client request was unsafe and the site content ratings feature was applied.
unsupp	The original client request was to an unsupported search engine.
err	The original client request was unsafe, but neither the safe search nor the site content ratings feature could be applied due to an error.
-	Neither the safe search nor the site content ratings feature was applied to the client request because the features were bypassed (for example, the transaction was allowed in a custom URL category) or the request was made from an unsupported application.

For more information on logging, see [Access Log File, page 24-14](#).

Requests blocked due to either the safe search or site content rating features, use one of the following ACL decision tags in the access logs:

- BLOCK\_SEARCH\_UNSAFE
- BLOCK\_CONTENT\_UNSAFE
- BLOCK\_UNSUPPORTED\_SEARCH\_APP
- BLOCK\_CONTINUE\_CONTENT\_UNSAFE

For more information on the ACL decision tags, see [ACL Decision Tags, page 24-17](#).

## Redirecting Traffic

In addition to using the Web Security appliance to monitor and block traffic to certain websites, you can also use it to redirect users to a different website. You can configure the appliance to redirect traffic originally destined for a URL in a custom URL category to a location you specify. This allows you to redirect traffic at the appliance instead of at the destination server.

You might want to redirect traffic at the appliance if your organization published the links to an internal site, but the location of the site changed since publication, or if you do not have control over the web server.

Configure the appliance to redirect custom URL categories to another location when you configure the URL categories for an Access Policy group. You can redirect traffic for a custom Access Policy group or the Global Policy Group.

To redirect traffic, you must define at least one custom URL category. For more information about creating custom URL categories, see [Creating and Editing Custom URL Categories, page 17-15](#).



### Note

Beware of infinite loops when you configure the appliance to redirect traffic. For example, if you redirect traffic destined for <http://A.example.com> to <http://B.example.com> and you also inadvertently redirect traffic destined for <http://B.example.com> to <http://A.example.com>, then you create an infinite loop. In this case, the appliance redirects the traffic back and forth between the two URLs indefinitely.

## Logging and Reporting

When you redirect traffic, the access log entry for the originally requested website has an ACL tag that starts with REDIRECT\_CUSTOMCAT. Later in the access log (typically the next line) appears the entry for the website to which the user was redirected.

The reports displayed on the Reporting tab display redirected transactions as “Allowed.”

## Redirecting Traffic in the Access Policies

- Step 1** Navigate to the Web Security Manager > Access Policies page.
- Step 2** Click the link under the URL Categories column for an Access Policy group or the Global Policy Group.
- Step 3** In the Custom URL Category Filtering section, click **Select Custom Categories**.
- Step 4** In the Select Custom Categories for this Policy dialog box, choose “Include in policy” for the custom URL category you want to redirect.
- Step 5** Click **Apply**.
- Step 6** Click the Redirect column for the custom category you want to redirect.
- Step 7** Enter the URL to which you want to redirect traffic in the Redirect To field for the custom category.

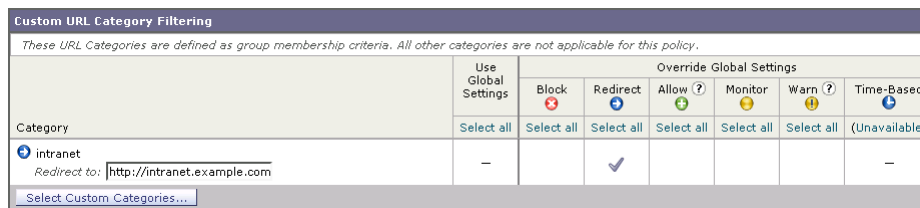

- Step 8** Submit and commit your changes.

## Warning Users and Allowing Them to Continue

In addition to using the Web Security appliance to block traffic to certain websites, you can also use it to warn users that a site does not meet the organization’s acceptable use policies and allow them to continue if they choose. You might want to warn users and allow them to continue if your organization wants to discourage its users from accessing certain sites, but does not want to or is not allowed by law to block access to those sites.

You can warn users and allow them to continue using one of the following methods:

- Choose the Warn action for a URL category in an Access Policy group.
- Enable the site content ratings feature and warn users that access adult content instead of blocking them. For more information on the site content ratings feature, see [Filtering Adult Content, page 17-17](#).

When users access a URL that is configured to warn and continue, they initially see an IronPort notification page with a warning about accessing sites of this category or content. The end-user URL filtering warning page includes the following elements:

- Default warning text provided by Cisco
- Custom text provided by the Web Security appliance administrator (optional)
- Notification code listing the invoked Access Policy and the URL category being warned or the safe browsing scanning verdict.
- A hypertext link to the originally requested URL

Users are tracked in the access log by user name if authentication has made a user name available, and tracked by IP address if no user name is available.

When you use the warn and continue feature, you can configure the following settings that affect the end-user URL filtering warning page:

- **Time Between Warning.** The Time Between Warning determines how often the Web Proxy displays the end-user URL filtering warning page for each URL category per user. Once a user clicks the continue link on the end-user URL filtering warning page, the Web Proxy considers that user to have acknowledged the warning for the time you enter for the Time Between Warning. This setting applies to users tracked by username and users tracked by IP address. You can specify any value from 30 to 2678400 seconds (one month). Default is 1 hour (3600 seconds).
- **Custom message.** The custom message is text you enter that appears on every end-user URL filtering warning page. You might want to include text for the organization's acceptable use policies, or include a link to a page that details the acceptable use policies. You can include some simple HTML tags to format the text. For example, you can change the color and size of the text, or make it italicized. See [Custom Text in Notification Pages, page 16-16](#) for more information.

Configure these settings on the Security Services > End-User Notification page. For more information, see [Configuring the End-User URL Filtering Warning Page, page 16-15](#).

**Note**

---

The warn and continue feature only works for HTTP and decrypted HTTPS transactions. It does not work with native FTP transactions.

---

## User Experience When Warning Users

When the URL filtering engine warns users for a particular request, it provides a warning page that the Web Proxy sends to the end user. However, not all websites display the warning page to the end user. For example, some Web 2.0 websites display dynamic content using javascript instead of a static webpage and are not likely to display the warning page from the Web Proxy. When this happens, users are blocked from the URL that is assigned the Warn option without being given the chance to continue accessing the site anyway.

## Creating Time Based URL Filters

You can configure how the Web Security appliance handles requests for URLs in particular categories differently based on time and day. For example, you can block access to social networking sites, such as blogs and forums, during business hours.

To define URL filtering actions by time you must first define at least one time range. For information about time ranges, see [Working with Time Based Policies, page 7-9](#).

---

**Step 1** Navigate to the Web Security Manager > Access Policies page.

- Step 2** Click the link in the policies table under the URL Categories column for the policy group you want to edit.
- Step 3** Select Time-Based for the custom or predefined URL category you want to configure based on time range.

**Figure 17-3** Defining Time Based URL Filtering Actions

Predefined URL Category Filtering					
<i>These URL Categories are defined as group membership criteria. All other categories are not applicable for this policy.</i>					
Category	Use Global Settings	Override Global Settings			Time-Based
	Select all	Monitor	Warn ?	Block	
Adult	<input checked="" type="checkbox"/>	<input type="checkbox"/>	<input type="checkbox"/>	<input type="checkbox"/>	<input type="checkbox"/>
Advertisements	<input checked="" type="checkbox"/>	<input type="checkbox"/>	<input type="checkbox"/>	<input type="checkbox"/>	<input type="checkbox"/>
Alcohol and Tobacco	<input checked="" type="checkbox"/>	<input type="checkbox"/>	<input type="checkbox"/>	<input type="checkbox"/>	<input type="checkbox"/>
Arts and Entertainment	<input type="checkbox"/>	<input type="checkbox"/>	<input type="checkbox"/>	<input type="checkbox"/>	<input checked="" type="checkbox"/>
In time range: <input type="text" value="BusinessHours"/>					
Action: <input type="text" value="Block"/>					
Otherwise: <input type="text" value="Use Global (Monitor)"/>					
Automatic Updating	<input checked="" type="checkbox"/>	<input type="checkbox"/>	<input type="checkbox"/>	<input type="checkbox"/>	<input type="checkbox"/>

When you select Time-Based for the URL category, additional fields appear under the category name where you can choose the actions.

- Step 4** In the In Time Range field, choose the defined time range to use for the URL category. For information about defining time ranges, see [Creating Time Ranges, page 7-9](#).
- Step 5** In the Action field, choose the action to enact on transactions in this URL category during the defined time range.
- Step 6** In the Otherwise field, choose the action to enact on transactions in this URL category *outside* the defined time range.
- Step 7** Submit and commit your changes.

## Viewing URL Filtering Activity

The Reporting > URL Categories page provides a collective display of URL statistics that includes information about top URL categories matched and top URL categories blocked. Additionally, this page displays category-specific data for bandwidth savings and web transactions. For detailed information about monitoring and reporting functionality, see [Reporting, page 22-1](#).

## Understanding Unfiltered and Uncategorized Data

When viewing URL statistics on the Reporting > URL Categories page, it is important to understand how to interpret the following data:

- **URL Filtering Bypassed** — This data represents policy, port, and admin user agent blocking that occurs before URL filtering.
- **Uncategorized URL** — This data represents all transactions for which the URL filtering engine is queried, but no category is matched.

## Access Log File

The access log file records the URL category for each transaction in the scanning verdict information section of each entry. For more information about the access log, see [Access Log File, page 24-14](#). For a list of each URL category, see [URL Category Descriptions, page 17-25](#).

## Regular Expressions

Regular expressions are pattern matching descriptions that contain normal printable characters and special characters that are used to match patterns in text strings. For example, a text string such as “welcome” matches “welcome” or “welcomemyfriend.” When a match occurs, the function returns true. If no match occurs, the function returns false. Actions are executed only when a pattern-matching expression is true.

The Web Security appliance uses POSIX extended regular expression syntax, fully described by IEEE POSIX 1003.2. However, the appliance does not support using a backward slash to escape a forward slash. If you need to use a forward slash in a regular expression, type the forward slash without a backward slash.

**Note**

---

Technically, AsyncOS for Web uses the Flex regular expression analyzer. For more detailed information about how it reads regular expressions, see <http://flex.sourceforge.net/manual/Patterns.html>.

---

You can use regular expressions in the following locations:

- **Custom URL categories for Access Policies.** When you create a custom URL category to use with Access Policy groups, you can use regular expressions to specify multiple web servers that match the pattern you enter. For more information about creating custom URL categories, see [Creating and Editing Custom URL Categories, page 17-15](#).
- **Custom user agents to block.** When you edit the applications to block for an Access Policy group, you can use regular expressions to enter specific user agents to block, such as Skype or Microsoft Internet Explorer. For more information about using regular expressions to block user agents, see [Policy: Protocols and User Agents, page 9-12](#).

**Note**

---

Regular expressions that perform extensive character matching consume resources and can affect system performance. For this reason, regular expressions should be cautiously applied.

---

## Forming Regular Expressions

Regular expressions are rules that typically use the word “matches” in the expression. They can be applied to match specific URL destinations or web servers. For example, the following regular expression matches any pattern containing blocksite.com:

```
\.blocksite\.com
```

Consider the following regular expression example:

```
server[0-9]\.example\.com
```

In this example, `server[0-9]` matches `server0`, `server1`, `server2`, ..., `server9` in the domain `example.com`.

In the following example, the regular expression matches files ending in .exe, .zip, and .bin in the downloads directory.

```
/downloads/.*\.(exe|zip|bin)
```

Avoid using regular expressions strings that are redundant because they can cause higher CPU usage on the Web Security appliance. A redundant regular expression is one that starts or ends with “.\*”.

**Note**

You must enclose regular expressions that contain blank spaces or non-alphanumeric characters in ASCII quotation marks.

## Regular Expression Character Table

Table 17-8 describes characters that are commonly used to form regular expressions:

**Table 17-8** Regular Expression Character Descriptions

Character	Description
.	Matches a single character.
*	Matches zero or more occurrences of the preceding regular expression. For example: [0-9]* matches any number of digits “.*” matches any arbitrary string of characters
^	Matches the beginning of a line as the first character of a regular expression.
\$	Matches the end of a line as the last character of a regular expression.
+	Matches one or more occurrences of the preceding regular expression.
?	Matches zero or one occurrence of the preceding regular expression.
	Matches the preceding regular expression or the following regular expression. For example: xly matches either x or y abclxyz matches either of the strings abc or xyz
[ ]	Matches the characters or digits that are enclosed within the brackets. For example: [a-z] matches any character between a and z [r-u] matches any of the characters r, s, t, or u [0-3] matches any of the single digits 0, 1, 2, 3
{ }	Specifies the number of times to match the previous pattern. For example: D{1,3} matches one to three occurrences of the letter D
( )	Group characters in a regular expression. For example: (abc)* matches abc or abcabcabc

**Table 17-8** Regular Expression Character Descriptions (continued)

Character	Description
"..."	Literally interprets any characters enclosed within the quotation marks.
\	Escape character.

**Note**

To match the literal version of any of the special characters, the character must be preceded by a backslash "\". For example, to exactly match a period "." the regular expression must use "\." as in "\.example\.com". However, the appliance does not support using a backward slash to escape a forward slash. If you need to use a forward slash in a regular expression, type the forward slash without a backward slash.

## URL Category Descriptions

This section lists the URL categories for Cisco IronPort Web Usage Controls. The tables also include the abbreviated URL category names that may appear in the Web Reputation filtering and anti-malware scanning section of an access log file entry.

**Tip**

To see what category a particular web site is assigned to, go to the URL in [Reporting Uncategorized and Misclassified URLs, page 17-3](#).

**Note**

In the access logs, the URL category abbreviations for Cisco IronPort Web Usage Controls include the prefix "IW\_" before each abbreviation so that the "art" category becomes "IW\_art."

[Table 17-9](#) lists and describes the URL categories for Cisco IronPort Web Usage Controls at the time of this release. For information about URL category set updates, including the location of any revisions to this list, see [Managing Updates to the Set of URL Categories, page 17-4](#).

**Table 17-9** URL Category Descriptions for Cisco IronPort Web Usage Controls

URL Category	Abbreviation	Code	Description	Example URLs
Adult	adlt	1006	Directed at adults, but not necessarily pornographic. May include adult clubs (strip clubs, swingers clubs, escort services, strippers); general information about sex, non-pornographic in nature; genital piercing; adult products or greeting cards; information about sex not in the context of health or disease.	www.adultentertainmentexpo.com www.adultnetline.com
Advertisements	adv	1027	Banner and pop-up advertisements that often accompany a web page; other advertising websites that provide advertisement content. Advertising services and sales are classified as "Business and Industry."	www.adforce.com www.doubleclick.com

Table 17-9 URL Category Descriptions for Cisco IronPort Web Usage Controls (continued)

URL Category	Abbreviation	Code	Description	Example URLs
Alcohol	alc	1077	Alcohol as a pleasurable activity; beer and wine making, cocktail recipes; liquor sellers, wineries, vineyards, breweries, alcohol distributors. Alcohol addiction is classified as “Health and Nutrition.” Bars and restaurants are classified as “Dining and Drinking.”	www.samueladams.com www.whisky.com
Arts	art	1002	Galleries and exhibitions; artists and art; photography; literature and books; performing arts and theater; musicals; ballet; museums; design; architecture. Cinema and television are classified as “Entertainment.”	www.moma.org www.nga.gov
Astrology	astr	1074	Astrology; horoscope; fortune telling; numerology; psychic advice; tarot.	www.astro.com www.astrology.com
Auctions	auct	1088	Online and offline auctions, auction houses, and classified advertisements.	www.craigslist.com www.ebay.com
Business and Industry	busi	1019	Marketing, commerce, corporations, business practices, workforce, human resources, transportation, payroll, security and venture capital; office supplies; industrial equipment (process equipment), machines and mechanical systems; heating equipment, cooling equipment; materials handling equipment; packaging equipment; manufacturing: solids handling, metal fabrication, construction and building; passenger transportation; commerce; industrial design; construction, building materials; shipping and freight (freight services, trucking, freight forwarders, truckload carriers, freight and transportation brokers, expedited services, load and freight matching, track and trace, rail shipping, ocean shipping, road feeder services, moving and storage).	www.freightcenter.com www.staples.com
Chat and Instant Messaging	chat	1040	Web-based instant messaging and chat rooms.	www.icq.com www.meebo.com
Cheating and Plagiarism	plag	1051	Promoting cheating and selling written work, such as term papers, for plagiarism.	www.bestessays.com www.superiorpapers.com
Child Abuse Content	cprn	1064	Worldwide illegal child sexual abuse content.	—
Computer Security	csec	1065	Offering security products and services for corporate and home users.	www.computersecurity.com www.symantec.com



Table 17-9 URL Category Descriptions for Cisco IronPort Web Usage Controls (continued)

URL Category	Abbreviation	Code	Description	Example URLs
Computers and Internet	comp	1003	Information about computers and software, such as hardware, software, software support; information for software engineers, programming and networking; website design; the web and Internet in general; computer science; computer graphics and clipart. "Freeware and Shareware" is a separate category.	www.xml.com www.w3.org
Dating	date	1055	Dating, online personals, matrimonial agencies.	www.eharmony.com www.match.com
Digital Postcards	card	1082	Enabling sending of digital postcards and e-cards.	www.all-yours.net www.delivr.net
Dining and Drinking	food	1061	Eating and drinking establishments; restaurants, bars, taverns, and pubs; restaurant guides and reviews.	www.hideawaybrewpub.com www.restaurantrow.com
Dynamic and Residential	dyn	1091	IP addresses of broadband links that usually indicates users attempting to access their home network, for example for a remote session to a home computer.	http://109.60.192.55 http://dynalink.co.jp http://ipadsl.net
Education	edu	1001	Education-related, such as schools, colleges, universities, teaching materials, and teachers' resources; technical and vocational training; online training; education issues and policies; financial aid; school funding; standards and testing.	www.education.com www.greatschools.org
Entertainment	ent	1093	Details or discussion of films; music and bands; television; celebrities and fan websites; entertainment news; celebrity gossip; entertainment venues. Compare with the "Arts" category.	www.eonline.com www.ew.com
Extreme	extr	1075	Material of a sexually violent or criminal nature; violence and violent behavior; tasteless, often gory photographs, such as autopsy photos; photos of crime scenes, crime and accident victims; excessive obscene material; shock websites.	www.car-accidents.com www.crime-scene-photos.com
Fashion	fash	1076	Clothing and fashion; hair salons; cosmetics; accessories; jewelry; perfume; pictures and text relating to body modification; tattoos and piercing; modeling agencies. Dermatological products are classified as "Health and Nutrition."	www.fashion.net www.findabeautysalon.com
File Transfer Services	fts	1071	File transfer services with the primary purpose of providing download services and hosted file sharing	www.rapidshare.com www.yousendit.com
Filter Avoidance	filt	1025	Promoting and aiding undetectable and anonymous web usage, including cgi, php and glype anonymous proxy services.	www.bypassschoolfilter.com www.filterbypass.com

Table 17-9 URL Category Descriptions for Cisco IronPort Web Usage Controls (continued)

URL Category	Abbreviation	Code	Description	Example URLs
Finance	fnc	1015	Primarily financial in nature, such as accounting practices and accountants, taxation, taxes, banking, insurance, investing, the national economy, personal finance involving insurance of all types, credit cards, retirement and estate planning, loans, mortgages. Stock and shares are classified as "Online Trading."	finance.yahoo.com www.bankofamerica.com
Freeware and Shareware	free	1068	Providing downloads of free and shareware software.	www.freewarehome.com www.shareware.com
Gambling	gamb	1049	Casinos and online gambling; bookmakers and odds; gambling advice; competitive racing in a gambling context; sports booking; sports gambling; services for spread betting on stocks and shares. Websites dealing with gambling addiction are classified as "Health and Nutrition." Government-run lotteries are classified as "Lotteries".	www.888.com www.gambling.com
Games	game	1007	Various card games, board games, word games, and video games; combat games; sports games; downloadable games; game reviews; cheat sheets; computer games and Internet games, such as role-playing games.	www.games.com www.shockwave.com
Government and Law	gov	1011	Government websites; foreign relations; news and information relating to government and elections; information relating to the field of law, such as attorneys, law firms, law publications, legal reference material, courts, dockets, and legal associations; legislation and court decisions; civil rights issues; immigration; patents and copyrights; information relating to law enforcement and correctional systems; crime reporting, law enforcement, and crime statistics; military, such as the armed forces, military bases, military organizations; anti-terrorism.	www.usa.gov www.law.com
Hacking	hack	1050	Discussing ways to bypass the security of websites, software, and computers.	www.hackthissite.org www.gohacking.com
Hate Speech	hate	1016	Websites promoting hatred, intolerance, or discrimination on the basis of social group, color, religion, sexual orientation, disability, class, ethnicity, nationality, age, gender, gender identity; sites promoting racism; sexism; racist theology; hate music; neo-Nazi organizations; supremacism; Holocaust denial.	www.kkk.com www.nazi.org

Table 17-9 URL Category Descriptions for Cisco IronPort Web Usage Controls (continued)

URL Category	Abbreviation	Code	Description	Example URLs
Health and Nutrition	hlth	1009	Health care; diseases and disabilities; medical care; hospitals; doctors; medicinal drugs; mental health; psychiatry; pharmacology; exercise and fitness; physical disabilities; vitamins and supplements; sex in the context of health (disease and health care); tobacco use, alcohol use, drug use, and gambling in the context of health (disease and health care); food in general; food and beverage; cooking and recipes; food and nutrition, health, and dieting; cooking, including recipe and culinary websites; alternative medicine.	www.health.com www.webmd.com
Humor	lol	1079	Jokes, sketches, comics and other humorous content. Adult humor likely to offend is classified as “Adult.”	www.humor.com www.jokes.com
Illegal Activities	ilac	1022	Promoting crime, such as stealing, fraud, illegally accessing telephone networks; computer viruses; terrorism, bombs, and anarchy; websites depicting murder and suicide as well as explaining ways to commit them.	www.ekran.no www.thedisease.net
Illegal Downloads	ildl	1084	Providing the ability to download software or other materials, serial numbers, key generators, and tools for bypassing software protection in violation of copyright agreements. Torrents are classified as “Peer File Transfer.”	www.keygenguru.com www.zcrack.com
Illegal Drugs	drug	1047	Information about recreational drugs, drug paraphernalia, drug purchase and manufacture.	www.cocaine.org www.hightimes.com
Infrastructure and Content Delivery Networks	infr	1018	Content delivery infrastructure and dynamically generated content; websites that cannot be classified more specifically because they are secured or otherwise difficult to classify.	www.akamai.net www.webstat.net
Internet Telephony	voip	1067	Telephonic services using the Internet.	www.evaphone.com www.skype.com
Job Search	job	1004	Career advice; resume writing and interviewing skills; job placement services; job databanks; permanent and temporary employment agencies; employer websites.	www.careerbuilder.com www.monster.com
Lingerie and Swimsuits	ling	1031	Intimate apparel and swimwear, especially when modeled.	www.swimsuits.com www.victoriasecret.com
Lotteries	lotr	1034	Sweepstakes, contests and state-sponsored lotteries.	www.calottery.com www.flalottery.com
Mobile Phones	cell	1070	Short Message Services (SMS); ringtones and mobile phone downloads. Cellular carrier websites are included in the “Business and Industry” category.	www.cbfsms.com www.zedge.net

Table 17-9 URL Category Descriptions for Cisco IronPort Web Usage Controls (continued)

URL Category	Abbreviation	Code	Description	Example URLs
Nature	natr	1013	Natural resources; ecology and conservation; forests; wilderness; plants; flowers; forest conservation; forest, wilderness, and forestry practices; forest management (reforestation, forest protection, conservation, harvesting, forest health, thinning, and prescribed burning); agricultural practices (agriculture, gardening, horticulture, landscaping, planting, weed control, irrigation, pruning, and harvesting); pollution issues (air quality, hazardous waste, pollution prevention, recycling, waste management, water quality, and the environmental cleanup industry); animals, pets, livestock, and zoology; biology; botany.	www.enature.com www.nature.org
News	news	1058	News; headlines; newspapers; television stations; magazines; weather; ski conditions.	www.cnn.com news.bbc.co.uk
Non-Governmental Organizations	ngo	1087	Non-governmental organizations such as clubs, lobbies, communities, non-profit organizations and labor unions.	www.panda.org www.unions.org
Non-Sexual Nudity	nsn	1060	Nudism and nudity; naturism; nudist camps; artistic nudes.	www.artenuda.com www.naturistsociety.com
Online Communities	comm	1024	Affinity groups; special interest groups; web newsgroups; message boards. Excludes websites classified as “Professional Networking” or “Social Networking.”	www.igda.org www.ieee.org
Online Storage and Backup	osb	1066	Offsite and peer-to-peer storage for backup, sharing, and hosting.	www.adrive.com www.dropbox.com
Online Trading	trad	1028	Online brokerages; websites that enable the user to trade stocks online; information relating to the stock market, stocks, bonds, mutual funds, brokers, stock analysis and commentary, stock screens, stock charts, IPOs, stock splits. Services for spread betting on stocks and shares are classified as “Gambling.” Other financial services are classified as “Finance.”	www.tdameritrade.com www.scottrade.com
Organizational Email	pem	1085	Websites used to access business email (often via Outlook Web Access).	—
Parked Domains	park	1092	Websites that monetize traffic from the domain using paid listings from an ad network, or are owned by “squatters” hoping to sell the domain name for a profit. These also include fake search websites which return paid ad links.	www.domainzaar.com www.parked.com
Peer File Transfer	p2p	1056	Peer-to-peer file request websites. This does not track the file transfers themselves.	www.bittorrent.com www.limewire.com

Table 17-9 URL Category Descriptions for Cisco IronPort Web Usage Controls (continued)

URL Category	Abbreviation	Code	Description	Example URLs
Personal Sites	pers	1081	Websites about and from private individuals; personal homepage servers; websites with personal contents; personal blogs with no particular theme.	www.karymullis.com www.stallman.org
Photo Searches and Images	img	1090	Facilitating the storing and searching for, images, photographs, and clip-art.	www.flickr.com www.photobucket.com
Politics	pol	1083	Websites of politicians; political parties; news and information on politics, elections, democracy, and voting.	www.politics.com www.thisnation.com
Pornography	porn	1054	Sexually explicit text or depictions. Includes explicit anime and cartoons; general explicit depictions; other fetish material; explicit chat rooms; sex simulators; strip poker; adult movies; lewd art; web-based explicit email.	www.redtube.com www.youporn.com
Professional Networking	pnet	1089	Social networking for the purpose of career or professional development. See also “Social Networking.”	www.linkedin.com www.europeanpwn.net
Real Estate	rest	1045	Information that would support the search for real estate; office and commercial space; real estate listings, such as rentals, apartments, and homes; house building.	www.realtor.com www.zillow.com
Reference	ref	1017	City and state guides; maps, time; reference sources; dictionaries; libraries.	www.wikipedia.org www.yellowpages.com
Religion	rel	1086	Religious content, information about religions; religious communities.	www.religionfacts.com www.religioustolerance.org
SaaS and B2B	saas	1080	Web portals for online business services; online meetings.	www.netsuite.com www.salesforce.com
Safe for Kids	kids	1057	Directed at, and specifically approved for, young children.	kids.discovery.com www.nickjr.com
Science and Technology	sci	1012	Science and technology, such as aerospace, electronics, engineering, mathematics, and other similar subjects; space exploration; meteorology; geography; environment; energy (fossil, nuclear, renewable); communications (telephones, telecommunications).	www.physorg.com www.science.gov
Search Engines and Portals	srch	1020	Search engines and other initial points of access to information on the Internet.	www.bing.com www.google.com
Sex Education	sxed	1052	Factual websites dealing with sex; sexual health; contraception; pregnancy.	www.avert.org www.scarleteen.com
Shopping	shop	1005	Bartering; online purchasing; coupons and free offers; general office supplies; online catalogs; online malls.	www.amazon.com www.shopping.com

Table 17-9 URL Category Descriptions for Cisco IronPort Web Usage Controls (continued)

URL Category	Abbreviation	Code	Description	Example URLs
Social Networking	snet	1069	Social networking. See also “Professional Networking.”	www.facebook.com www.twitter.com
Social Science	socs	1014	Sciences and history related to society; archaeology; anthropology; cultural studies; history; linguistics; geography; philosophy; psychology; women's studies.	www.archaeology.org www.anthropology.net
Society and Culture	scty	1010	Family and relationships; ethnicity; social organizations; genealogy; seniors; child-care.	www.childcare.gov www.familysearch.org
Software Updates	swup	1053	Websites that host updates for software packages.	www.softwarepatch.com www.versiontracker.com
Sports and Recreation	sprt	1008	All sports, professional and amateur; recreational activities; fishing; fantasy sports; public parks; amusement parks; water parks; theme parks; zoos and aquariums; spas.	www.espn.com www.recreation.gov
Streaming Audio	aud	1073	Real-time streaming audio content including Internet radio and audio feeds.	www.live-radio.net www.shoutcast.com
Streaming Video	vid	1072	Real-time streaming video including Internet television, web casts, and video sharing.	www.hulu.com www.youtube.com
Tobacco	tob	1078	Pro-tobacco websites; tobacco manufacturers; pipes and smoking products (not marketed for illegal drug use). Tobacco addiction is classified as “Health and Nutrition.”	www.bat.com www.tobacco.org
Transportation	trns	1044	Personal transportation; information about cars and motorcycles; shopping for new and used cars and motorcycles; car clubs; boats, airplanes, recreational vehicles (RVs), and other similar items. Note, car and motorcycle racing is classified as “Sports and Recreation.”	www.cars.com www.motorcycles.com
Travel	trvl	1046	Business and personal travel; travel information; travel resources; travel agents; vacation packages; cruises; lodging and accommodation; travel transportation; flight booking; airfares; car rental; vacation homes.	www.expedia.com www.lonelyplanet.com
Unclassified	—	—	Websites which are not in the Cisco database are recorded as unclassified for reporting purposes. This may include mistyped URLs.	—

Table 17-9 URL Category Descriptions for Cisco IronPort Web Usage Controls (continued)

URL Category	Abbreviation	Code	Description	Example URLs
Weapons	weap	1036	Information relating to the purchase or use of conventional weapons such as gun sellers, gun auctions, gun classified ads, gun accessories, gun shows, and gun training; general information about guns; other weapons and graphic hunting sites may be included. Government military websites are classified as "Government and Law."	www.coldsteel.com www.gunbroker.com
Web Hosting	whst	1037	Website hosting; bandwidth services.	www.bluehost.com www.godaddy.com
Web Page Translation	tran	1063	Translation of web pages between languages.	babelfish.yahoo.com translate.google.com
Web-Based Email	mail	1038	Public web-based email services. Websites enabling individuals to access their company or organization's email service are classified as "Organizational Email."	mail.yahoo.com www.hotmail.com





# 18

## Understanding Application Visibility and Control

- [Controlling Applications Overview, page 18-1](#)
- [Understanding Application Control Settings, page 18-3](#)
- [Controlling Bandwidth, page 18-7](#)
- [Controlling Instant Messaging Traffic, page 18-10](#)
- [Viewing AVC Activity, page 18-11](#)

### Controlling Applications Overview

The Web has become the ubiquitous platform for application delivery in the enterprise, whether that is browser based application platforms like Salesforce.com and Google Apps, or rich media applications like Cisco WebEx using web protocols as a widely available transport in and out of enterprise networks.

Cisco IronPort Web Usage Controls includes the Application Visibility and Control engine (AVC engine) which enables administrators to apply deeper controls to particular application types. The AVC engine is an acceptable use policy component that inspects web traffic to gain deeper understanding and control of web traffic used for applications. Application control gives you more granular control over web traffic than just URL filtering, for example.

The AVC engine allows you to create policies to control application activity on the network without having to fully understand the underlying technology of each application.

Application control gives you visibility and control over the following types of applications:

- Evasive applications, such as anonymizers and encrypted tunnels.
- Collaboration applications, such as Cisco Webex and instant messaging.
- Resource intensive applications, such as streaming media.

To control applications using the AVC engine, perform the following steps:

1. Enable the AVC engine. For more information, see [Enabling the AVC Engine, page 18-2](#).
2. Define application control settings in the Access Policies. For more information, see [Understanding Application Control Settings, page 18-3](#).

Using the AVC engine, you can block or allow applications by application type or a particular application. You can also apply deeper controls to particular application types. For example, you can perform the following tasks:

- **Limit bandwidth consumed by some application types to control congestion.** For more information, see [Controlling Bandwidth, page 18-7](#).
- **Allow instant messaging traffic, but disallow file sharing using instant messenger.** For more information, see [Controlling Instant Messaging Traffic, page 18-10](#).
- **Enforce safe search on search engines and user generated content sites.** For more information, see [Filtering Adult Content, page 17-17](#).

- **Restrict access to adult content on some content sharing sites.** For more information, see [Filtering Adult Content, page 17-17](#).

The AVC engine can dynamically receive updates from the Cisco IronPort update server, including support for new applications and application types. For more information, see [AVC Engine Updates, page 18-2](#).

You can also view the AVC engine scanning activity in the Application Visibility report on the Reporting > Application Visibility page. For more information, see [Viewing AVC Activity, page 18-11](#).

## User Experience with Blocked Requests

When the AVC engine blocks a transaction, the Web Proxy sends a block page to the end user. However, not all websites display the block page to the end user. For example, some Web 2.0 websites display dynamic content using javascript instead of a static webpage and are not likely to display the block page. Users are still properly blocked from downloading malicious data, but they may not always be informed of this by the website.

## AVC Engine Updates

AsyncOS periodically queries the update servers for new updates to all security service components, including the AVC engine. AVC engine updates can include support for new application types and applications as well as updated support for existing applications if any application behavior changes. By updating the AVC engine in between AsyncOS versions, the Web Security appliance remains flexible without requiring a server upgrade.

AVC engine updates are maintained by the Cisco Security Intelligence Operations (SIO) center. Cisco SIO updates signatures as necessary to adapt to the changing marketplace.

Because the AVC engine can receive support for new applications and application types, AsyncOS for Web assigns the following default actions for the Global Access Policy:

- New application types default to Monitor.
- New application behaviors, such as block file transfer within a particular application, default to Monitor.
- New applications for an existing application type default to the application type default.

## Enabling the AVC Engine

Enable the AVC engine when you enable Cisco IronPort Web Usage Controls.

- 
- Step 1** Navigate to the Security Services > Acceptable Use Controls page.
  - Step 2** Click **Edit Global Settings**.
  - Step 3** Verify the Enable Acceptable Use Controls property is enabled.
  - Step 4** In the Acceptable Use Controls Service area, select Cisco IronPort Web Usage Controls, and then select Enable Application Visibility and Control.
  - Step 5** Submit and commit your changes.
-

# Understanding Application Control Settings

Controlling applications involves configuring the following elements:

- **Application types.** A category that contains one or more applications. For example, Instant Messaging is an application type that contains Google Talk and AOL Instant Messenger.
- **Applications.** Particular applications that belong in an application type. For example, YouTube is an application in the Media application type.
- **Application behaviors.** Particular actions or behaviors that users can do within an application that administrators can control. For example, users can transfer files while using an application, such as Yahoo Messenger. Not all applications include application behaviors you can configure.

You can configure application control settings in Access Policy groups. From the Web Security Manager > Access Policies page, click the Applications link for the policy group you want to configure. The Access Policies: Applications Visibility and Control: *polycyname* page appears, or the “Applications Visibility and Control page” for short.

The Applications Visibility and Control page shows the current applications you can configure as determined by the current AVC engine signature. Regardless of the particular applications you can configure, the Applications Visibility and Control page offers the following views for configuring applications:

- **Browse view.** You can browse for application types. You might want to use Browse view to configure applications of a particular type at the same time. For more information, see [Working with Browse View, page 18-3](#).
- **Search view.** You can search for applications. You might want to use Search view when the total list of applications is long and you need to quickly find and configure a particular application. For more information, see [Working with Search View, page 18-5](#).

You can configure most of the same control settings in both views. However, you can only configure the bandwidth control limits for application types in Browse view.

When configuration applications, you can choose the following actions:

- **Block.** This action is a final action. Users are prevented from viewing a webpage and instead an end-user notification page displays.
- **Monitor.** This action is an intermediary action. The Web Proxy continues comparing the transaction to the other control settings to determine which final action to apply. For more information, see [Understanding the Monitor Action, page 9-3](#).
- **Restrict.** This action indicates that an application behavior is blocked. For example, when you block file transfers for a particular instant messaging application, the action for that application is Restrict.

## Working with Browse View

[Figure 18-1](#) shows the Applications Visibility and Control page in Browse view for a user defined Access Policy.

Figure 18-1 Configuring Applications for a User Defined Access Policy—Browse View

Access Policies: Applications Visibility and Control: AccessPolicy

Edit Applications Settings

Define Applications Custom Settings

Applications Settings

Browse Application Types

To identify some applications, inspection of HTTPS content may be required. For best efficacy, enable the HTTPS Proxy, then select the option that enables decryption for application visibility and control (see Security Services > HTTPS Proxy).

Applications	Settings
<ul style="list-style-type: none"> <li>Instant Messaging                             <ul style="list-style-type: none"> <li>AOL Instant Messenger</li> <li>Google Talk</li> <li>MSN Messenger</li> <li>Yahoo Messenger</li> </ul> </li> <li>Media                             <ul style="list-style-type: none"> <li>Bandwidth Limit: No Bandwidth Limit</li> <li>10 Monitor</li> </ul> </li> <li>P2P / File Sharing                             <ul style="list-style-type: none"> <li>3 Monitor</li> </ul> </li> <li>Presentation / Conferencing                             <ul style="list-style-type: none"> <li>1 Monitor</li> </ul> </li> <li>Social Networking                             <ul style="list-style-type: none"> <li>1 Monitor</li> </ul> </li> </ul>	<ul style="list-style-type: none"> <li>Use Global (Monitor)</li> <li>Use Global (Monitor)</li> <li>Use Global (Monitor)</li> </ul> <div style="border: 1px solid black; padding: 5px;"> <p><b>Set action for application Yahoo Messenger</b></p> <p><input checked="" type="radio"/> Use Global Setting (Monitor)</p> <p><input type="radio"/> Monitor</p> <p><input type="checkbox"/> Block File Transfer</p> <p><input type="radio"/> Block</p> <p>Cancel Apply</p> </div>

Total: 19 Applications (19 Monitored)

Click to expand application type and configure each application.

Click to define the same action for all applications in the type.

Click to configure this application.

Configure the settings for this application.

Click to define the bandwidth limit for the entire application type.

Applications

Application Type

Application Behavior

Figure 18-2 shows the Applications Visibility and Control page in Browse view for the Global Access Policy.

**Figure 18-2** Configuring Applications for the Global Access Policy—Browse View

Access Policies: Applications Visibility and Control: Global Policy

**Default Actions for Application Types**

Application Types	Default Action for Type
Instant Messaging	Set default action for application type: Instant Messaging <input type="radio"/> Block <input checked="" type="radio"/> Monitor <input type="button" value="Cancel"/> <input type="button" value="Apply"/>
Media	Set Bandwidth Limit for Application Type: Media <input checked="" type="radio"/> No Bandwidth Limit for Application Type <input type="radio"/> Set Bandwidth Limit: <input type="text"/> kbps per user <input type="button" value="Cancel"/> <input type="button" value="Apply"/>
P2P / File Sharing	Monitor
Presentation / Conferencing	Monitor
Social Networking	Monitor

**Edit Applications Settings**

Browse Application Types ▾ Applications Info ⓘ

*To identify some applications, inspection of HTTPS content may be required. For best efficacy, enable the HTTPS Proxy, then select the option that enables decryption for application visibility and control (see Security Services > HTTPS Proxy).*

Applications	Settings
Instant Messaging	4 Monitor <a href="#">Edit all...</a>
Media	10 Monitor <a href="#">Edit all...</a>
P2P / File Sharing	3 Monitor <a href="#">Edit all...</a>
Presentation / Conferencing	1 Monitor <a href="#">Edit all...</a>
Social Networking	1 Monitor <a href="#">Edit all...</a>

Total: 19 Applications (19 Monitored)

Define global settings for each application and application behavior.

Click to define the default action for the application type.

Configure the bandwidth limit for the type.

Configure the default action for the type.

## Working with Search View

Figure 18-3 shows the Applications Visibility and Control page in Search view for a user defined Access Policy.

Figure 18-3 Configuring Applications for a User Defined Access Policy—Search View

Access Policies: Applications Visibility and Control: AccessPolicy

Edit Applications Settings

Define Applications Custom Settings

Applications Settings

Search for Applications

Applications Info

Filter By:

Application Type: All

Application Name: Starts With

Current Action: All

Application Types	Applications	Actions
Instant Messaging	AOL Instant Messenger	Use Global (Monitor)
Media	ASF	Set action for application ASF <input checked="" type="radio"/> Use Global Setting (Monitor); No Bandwidth Limit <input type="radio"/> Monitor <input type="radio"/> Block Bandwidth Limit: <input type="radio"/> Use Setting from Type (No Bandwidth Limit) <input type="radio"/> No Bandwidth Limit Cancel Apply
P2P / File Sharing	BitTorrent	Use Global (Monitor)
Social Networking	Facebook	Use Global (Monitor)
Media	Flash Video	Use Global (Monitor); No Bandwidth Limit
Instant Messaging	Google Talk	Use Global (Monitor)
Media	Hulu	Use Global (Monitor); No Bandwidth Limit
Media	MPEG	Use Global (Monitor); No Bandwidth Limit
Instant Messaging	MSN Messenger	Use Global (Monitor)
Media	QuickTime	Use Global (Monitor); No Bandwidth Limit
Media	RealMedia	Use Global (Monitor); No Bandwidth Limit
Media	Silverlight	Use Global (Monitor); No Bandwidth Limit
Media	Viddler	Use Global (Monitor); No Bandwidth Limit
Presentation / Conferencing	WebEx	Use Global (Monitor)
Media	Windows Media	Use Global (Monitor); No Bandwidth Limit
Instant Messaging	Yahoo Messenger	Use Global (Monitor)
P2P / File Sharing	Yourfilehost	Use Global (Monitor)

Total: 19 Applications (19 Monitored)  
Current Search: 19 Applications (19 Monitored)

Configure search criteria.

Click to column headers to sort columns.

Click to configure this application.

Configure the settings for this application.

## Rules and Guidelines

Consider the following rules and guidelines when configuring application control settings:

- The supported application types, applications, and application behaviors may change between AsyncOS for Web upgrades during AVC engine updates.
- When an application type is collapsed in Browse view, the summary for the application type lists the final actions for the applications and does not indicate whether the actions are inherited from the global policy or configured in the current Access Policy. To learn more about the action for an application, expand the application type.
- In the Global Access Policy, you can set the default action for each application type. You might want to set the default action for each application type so new applications introduced in an Application Visibility and Control engine update automatically inherit the default action.

- You can quickly configure the same action for all applications in an application type by clicking the “edit all” link for the application type in Browse view. However, you can only configure the application action, not application behavior actions. To configure application behaviors, you must edit the application individually instead of editing all applications for a type at once.
- In Search view, when you sort the table by the action column, the sort order is by the final action. For example, “Use Global (Block)” comes after “Block” in the sort order.
- Decryption may cause some applications to fail unless the root certificate for signing is installed on the client.

#### Related topics

- [Certificates, page 11-3](#)
- [Decryption with the AVC Engine, page 11-6](#)

## Configuring Application Control Settings in an Access Policy Group

- 
- Step 1** Navigate to the Web Security Manager > Access Policies page.
- Step 2** Click the link in the policies table under the Applications column for the policy group you want to edit.
- Step 3** When configuring the Global Access Policy, define the default action for each application type in the Default Actions for Application Types section. For details on how to do this, see [Figure 18-2 on page 18-5](#).
- Step 4** When configuring a user defined Access Policy, choose Define Applications Custom Settings in the Edit Applications Settings section.
- Step 5** In the Application Settings area, choose Browse view or Search view from the drop down menu.
- Step 6** Configure the action for each application and application behavior.  
For more information on work with each view, see [Working with Browse View, page 18-3](#) and [Working with Search View, page 18-5](#).
- Step 7** Configure the bandwidth controls for each applicable application. For more information, see [Controlling Bandwidth, page 18-7](#).
- Step 8** Submit and commit your changes.
- 

## Controlling Bandwidth

The AVC engine allows administrators to control the amount of bandwidth used for particular application types. Not all application types support bandwidth controls.

You can define the following bandwidth limits:

- **Overall bandwidth limit.** Define an overall limit for all users on the network for the supported application types. The overall bandwidth limit affects the traffic between the Web Security appliance and web servers. It does not limit traffic served from the web cache. You might want to define an overall bandwidth limit to restrict the amount of network traffic used for high traffic sites, such as streaming media sites. For more information, see [Configuring Overall Bandwidth Limits, page 18-8](#).

- **User bandwidth limit.** Define a limit for particular users on the network per application type. User bandwidth limits traffic from web servers as well as traffic served from the web cache. You might want to define user bandwidth limits to restrict the amount of traffic consumed by heavy usage users to enforce acceptable use policies. For more information, see [Configuring User Bandwidth Limits, page 18-8](#).

When both the overall limit and user limit applies to a transaction, the most restrictive option applies.

You can define bandwidth limits for particular URL categories by defining an Identity group for a URL category and using it in an Access Policy that restricts the bandwidth.

**Note**

Defining bandwidth limits only throttles the data going to users. It does not block data based on reaching a quota. The Web Proxy introduces latency into each application transaction to mimic a slower link to the server.

## Configuring Overall Bandwidth Limits

The overall bandwidth limit affects the traffic between the Web Security appliance and web servers for all users on the network.

- 
- Step 1** Navigate to the Web Security Manager > Overall Bandwidth Limits page.
  - Step 2** Select the Limit to option.
  - Step 3** Enter the amount of traffic to limit in either Megabits per second (Mbps) or kilobits per second (kbps).
  - Step 4** Submit and commit your changes.
- 

## Configuring User Bandwidth Limits

You define user bandwidth limits by configuring bandwidth control settings on the Applications Visibility and Control page of Access Policies. You can define the following types of bandwidth controls for users in Access Policies:

- **Default bandwidth limit for an application type.** In the Global Access Policy, you can define the default bandwidth limit for all applications of an application type. For more information, see [Configuring the Default Bandwidth Limit for an Application Type, page 18-9](#).
- **Bandwidth limit for an application type.** In a user defined Access Policy, you can override the default bandwidth limit for the application type defined in the Global Access Policy. You can configure no bandwidth limit or a different bandwidth limit value. For more information, see [Overriding the Default Bandwidth Limit for an Application Type, page 18-9](#).
- **Bandwidth limit for an application.** In a user defined or Global Access Policy, you can choose to apply the application type bandwidth limit or no limit (exempt the application type limit). You might choose no bandwidth limit for an application to exempt the application from the bandwidth limit established that application type. For more information, see [Configuring Bandwidth Controls for an Application, page 18-10](#).



## Configuring the Default Bandwidth Limit for an Application Type

- Step 1** Navigate to the Web Security Manager > Access Policies page.
- Step 2** Click the link in the policies table under the Applications column for the Global Access Policy.
- Step 3** In the Default Actions for Application Types section, click the link next to “Bandwidth Limit” for the application type you want to edit.
- Step 4** Select Set Bandwidth Limit and enter the amount of traffic to limit in either Megabits per second (Mbps) or kilobits per second (kbps). See [Figure 18-2 on page 18-5](#) for details on how to do this.
- Step 5** Click Done.
- Step 6** Submit and commit your changes.

## Overriding the Default Bandwidth Limit for an Application Type

You can override the default bandwidth limit defined at the Global Access Policy group in the user defined Access Policies. You can only do this in Browse view.

- Step 1** Navigate to the Web Security Manager > Access Policies page.
- Step 2** Click the link in the policies table under the Applications column for the user defined policy group you want to edit.
- Step 3** Choose Define Applications Custom Settings in the Edit Applications Settings section.



**Note** Ensure you remain in Browse view. Do not switch to Search view.

**Figure 18-4** Overriding the Default Bandwidth Limit for an Application Type

Access Policies: Applications Visibility and Control: AccessPolicy

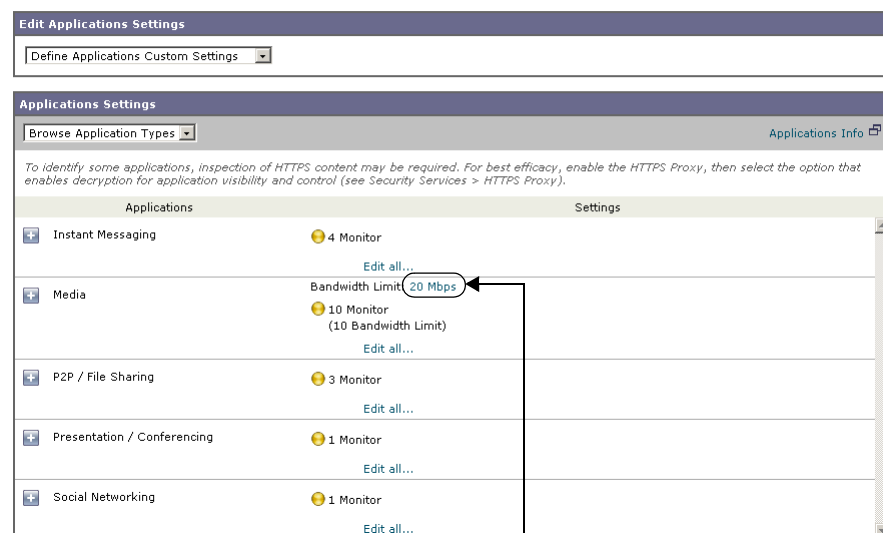

Click to override default bandwidth limit.

- Step 4** Click the link next to “Bandwidth Limit” for the application type you want to edit.
  - Step 5** To choose a different bandwidth limit value, select Set Bandwidth Limit and enter the amount of traffic to limit in either Megabits per second (Mbps) or kilobits per second (kbps). To specify no bandwidth limit, select No Bandwidth Limit for Application Type.
  - Step 6** Click Done.
  - Step 7** Submit and commit your changes.
- 

## Configuring Bandwidth Controls for an Application

---

- Step 1** Navigate to the Web Security Manager > Access Policies page.
- Step 2** Click the link in the policies table under the Applications column for the policy group you want to edit.
- Step 3** Expand the application type that contains the application you want to define.
- Step 4** Click the link for the application you want to configure.
- Step 5** Select Monitor, and then choose to use either the bandwidth limit defined for the application type or no limit.



**Note** The bandwidth limit setting is not applicable when the application is blocked or when no bandwidth limit is defined for the application type.

---

- Step 6** Click Done.
  - Step 7** Submit and commit your changes.
- 

## Controlling Instant Messaging Traffic

You can use the AVC engine to apply control settings to some instant messenger (IM) traffic that runs on top of HTTP. You can block or monitor the IM traffic, and depending on the IM service, you can block particular activities (also known as application behaviors) in an IM session. For example, you can allow an IM session with a particular IM service provider, but block file transfers within that session.

The AVC engine does not control native IM traffic.

You control IM traffic by configuring Instant Messenger application settings on the Applications Visibility and Control page of Access Policies.

---

- Step 1** Navigate to the Web Security Manager > Access Policies page.
- Step 2** Click the link in the policies table under the Applications column for the policy group you want to edit.
- Step 3** Expand the Instant Messaging application type.
- Step 4** Click the link next to the IM application you want to configure.
- Step 5** To block all traffic for this IM application, select Block.
- Step 6** To monitor the IM application, but block particular activities within the application, select Monitor, and then select the application behavior to block.

- Step 7** Click Done.
- Step 8** Submit and commit your changes.
- 

## Viewing AVC Activity

The Reporting > Application Visibility page displays information about the top applications and application types used. It also displays the top applications and application types blocked. You can click the individual applications and application types to view more detailed information about each. For detailed information about monitoring and reporting functionality, see [Reporting, page 22-1](#).

## Access Log File

The access log file records the information returned by the Application Visibility and Control engine for each transaction. The scanning verdict information section in the access logs includes the fields listed in [Table 18-1](#).

**Table 18-1** Application Visibility Control Logging Information

Description	Custom Field in Access Logs	Custom Field in W3C Logs
Application name	%XO	x-avc-app
Application type	%Xu	x-avc-type
Application behavior	%Xb	x-avc-behavior

For more information about the access log, see [Access Log File, page 24-14](#).



# 19

## Configuring Security Services

---

- [Configuring Security Services Overview, page 19-1](#)
- [Web Reputation Filters Overview, page 19-2](#)
- [Anti-Malware Scanning Overview, page 19-4](#)
- [Understanding Adaptive Scanning, page 19-8](#)
- [Enabling Web Reputation and Anti-Malware Filters, page 19-9](#)
- [Configuring Web Reputation and Anti-Malware in Policies, page 19-10](#)
- [Maintaining the Database Tables, page 19-16](#)
- [Logging, page 19-17](#)
- [Caching, page 19-17](#)
- [Malware Category Descriptions, page 19-18](#)

## Configuring Security Services Overview

The Web Security appliance uses multiple security components to protect end users from a broad range of web-based malware threats:

- **Anti-malware scanning.** The Cisco IronPort DVST<sup>™</sup> engine works with multiple anti-malware scanning engines integrated on the appliance to block malware threats. For more information, see [Anti-Malware Scanning Overview, page 19-4](#).
- **Web Reputation Filters.** This is a security feature that analyzes web server behavior and assigns a reputation score to a URL to determine the likelihood that it contains URL-based malware. For more information, see [Web Reputation Filters Overview, page 19-2](#).

To protect end users from malware, you enable these features on the appliance, and then configure anti-malware and web reputation settings per policy. For more information, see [Enabling Web Reputation and Anti-Malware Filters, page 19-9](#) and [Configuring Web Reputation and Anti-Malware in Policies, page 19-10](#).

You can configure anti-malware and web reputation settings for each policy group, but when you configure Access Policies, you can also have AsyncOS for Web choose the best combination of anti-malware scanning and web reputation scoring to use when determining what content to block. For more information, see [Understanding Adaptive Scanning, page 19-8](#).

# Web Reputation Filters Overview

Web Reputation Filters is a security feature that analyzes web server behavior and assigns a web-based reputation score (WBRS) to a URL to determine the likelihood that it contains URL-based malware. It helps protect against URL-based malware that threatens end-user privacy and sensitive corporate information. The Web Security appliance uses web reputation scores to identify suspicious activity and stop malware attacks before they occur.

Web Reputation Filters are designed to combat the increasingly prevalent and dynamic nature of malware, especially to protect users from legitimate web sites that have been compromised by malware writers.

You can use Web Reputation Filters with Access, Decryption, and Cisco IronPort Data Security Policies.

## Web Reputation Scores

Web Reputation Filters use statistically significant data to assess the reliability of Internet domains and score the reputation of URLs. Data such as how long a specific domain has been registered, or where a web site is hosted, or whether a web server is using a dynamic IP address is used to judge the trustworthiness of a given URL.

The web reputation calculation associates a URL with network parameters to determine the probability that malware exists. The aggregate probability that malware exists is then mapped to a Web Reputation Score between -10 and +10, with +10 being the least likely to contain malware.

Example parameters include the following:

- URL categorization data
- Presence of downloadable code
- Presence of long, obfuscated End-User License Agreements (EULAs)
- Global volume and changes in volume
- Network owner information
- History of a URL
- Age of a URL
- Presence on any block lists
- Presence on any allow lists
- URL typos of popular domains
- Domain registrar information
- IP address information

**Note**

---

Cisco does not collect personally identifiable information such as user names, passwords, or client IP addresses.

---

## Understanding How Web Reputation Filtering Works

Web Reputation Scores are associated with an action to take on a URL request. The available actions depend on the policy group type that is assigned to the URL request:

- **Access Policies.** You can choose to block, scan, or allow.
- **Decryption Policies.** You can choose to drop, decrypt, or pass through.
- **Cisco IronPort Data Security Policies.** You can choose to block or monitor.

You can configure each policy group to correlate an action to a particular Web Reputation Score.

## Web Reputation in Access Policies

When you configure web reputation settings in Access Policies, you can choose to configure the settings manually, or let AsyncOS for Web choose the best options using Adaptive Scanning.

When Adaptive Scanning is enabled, you can enable or disable web reputation filtering in each Access Policy, but you cannot edit the Web Reputation Scores. For more information on Adaptive Scanning, see [Understanding Adaptive Scanning, page 19-8](#).

[Table 19-1](#) describes the default Web Reputation Scores for Access Policies that you can edit when Adaptive Scanning is disabled.

**Table 19-1** Default Web Reputation Scores for Access Policies

Score	Action	Description	Example
-10 to -6.0	Block	Bad site. The request is blocked, and no further malware scanning occurs.	<ul style="list-style-type: none"> <li>• URL downloads information without user permission.</li> <li>• Sudden spike in URL volume.</li> <li>• URL is a typo of a popular domain.</li> </ul>
-5.9 to 5.9	Scan	Undetermined site. Request is passed to the DVS engine for further malware scanning. The DVS engine scans the request and server response content.	<ul style="list-style-type: none"> <li>• Recently created URL that has a dynamic IP address and contains downloadable content.</li> <li>• Network owner IP address that has a positive Web Reputation Score.</li> </ul>
6.0 to 10.0	Allow	Good site. Request is allowed. No malware scanning required.	<ul style="list-style-type: none"> <li>• URL contains no downloadable content.</li> <li>• Reputable, high-volume domain with long history.</li> <li>• Domain present on several allow lists.</li> <li>• No links to URLs with poor reputations.</li> </ul>

For example, by default, URLs in an HTTP request that are assigned a Web Reputation Score of +7 are allowed and require no further scanning. However, a weaker score for an HTTP request, such as +3, is automatically forwarded to the Cisco IronPort DVS engine where it is scanned for malware. Any URL in an HTTP request that has a very poor reputation is blocked.

## Web Reputation in Decryption Policies

Table 19-2 describes the default Web Reputation Scores for Decryption Policies.

**Table 19-2** Default Web Reputation Scores for Decryption Policies

Score	Action	Description
-10 to -9.0	Drop	Bad site. The request is dropped with no notice sent to the end user. Use this setting with caution.
-8.9 to 5.9	Decrypt	Undetermined site. Request is allowed, but the connection is decrypted and Access Policies are applied to the decrypted traffic. For more information about how the appliance decrypts HTTPS traffic, see <a href="#">Certificates, page 11-3</a> .
6.0 to 10.0	Pass through	Good site. Request is passed through with no inspection or decryption.

## Web Reputation in Cisco IronPort Data Security Policies

Table 19-3 describes the default Web Reputation Scores for Cisco IronPort Data Security.

**Table 19-3** Default Web Reputation Scores for Cisco IronPort Data Security Policies

Score	Action	Description
-10 to -6.0	Block	Bad site. The transaction is blocked, and no further scanning occurs.
-5.9 to 0.0	Monitor	The transaction will not be blocked based on Web Reputation, and will proceed to content checks (file type and size). <b>Note</b> Sites with no score are monitored.

# Anti-Malware Scanning Overview

The Web Security appliance anti-malware feature is a security component that uses the Cisco IronPort DVST<sup>™</sup> engine in combination with multiple anti-malware scanning engines integrated on the appliance to identify and stop web-based malware threats, including zero-day threats. The DVS engine works with the Webroot<sup>™</sup>, McAfee, and Sophos anti-malware scanning engines.

For more information about the DVS engine, see [Cisco IronPort DVST<sup>™</sup> \(Dynamic Vectoring and Streaming\) Engine, page 19-4](#).

To use the anti-malware component of the appliance, you must first enable anti-malware scanning and configure global settings, and then apply specific settings to different policies. For more information, see [Enabling Web Reputation and Anti-Malware Filters, page 19-9](#) and [Configuring Web Reputation and Anti-Malware in Policies, page 19-10](#).

## Cisco IronPort DVST<sup>™</sup> (Dynamic Vectoring and Streaming) Engine

The Cisco IronPort Dynamic Vectoring and Streaming (DVS) engine inspects web traffic to provide protection against the widest variety of web-based malware ranging from commercially invasive adware applications, to malicious trojans, system monitors, and phishing attacks.



The Cisco IronPort DVS engine can use one or more scanning engines to determine malware risk. Depending on the features purchased with the appliance, you can enable any of the following scanning engines:

- **Webroot.** Webroot's automated spyware detection system rapidly identifies existing and new spyware threats on the Internet by intelligently scanning millions of sites on a daily basis. Webroot uses a signature database to help detect threats on the Internet. For more information, see [Webroot Scanning, page 19-6](#).
- **McAfee.** The McAfee scanning engine can detect existing and new malware threats by using a signature database of malware information and heuristic analysis. For more information, see [McAfee Scanning, page 19-7](#).
- **Sophos.** The Sophos scanning engine detects existing and new malware threats using a signature database. For more information, see [Sophos Scanning, page 19-8](#).

The scanning engines inspect transactions to determine a malware scanning verdict to pass to the DVS engine. A malware scanning verdict is a value assigned to a URL request or server response that determines the probability that it contains malware. The DVS engine determines whether to monitor or block the request based on the malware scanning verdicts. For more information about malware scanning verdicts, see [Malware Scanning Verdict Values, page 24-38](#).

Although you can enable all scanning engines globally, you can enable either the Sophos or McAfee scanning engine (but not both simultaneously) to each Access or Outbound Malware Scanning Policy. Similarly, you can also enable the Webroot scanning engine with either Sophos or McAfee to each Access or Outbound Malware Scanning Policy. You might want to enable the Sophos scanning engine instead of the McAfee scanning engine if the client machines have McAfee anti-malware software installed.

In some cases, the DVS engine might determine multiple verdicts for a single URL. For more information about how the DVS handles multiple verdicts, see [Working with Multiple Malware Verdicts, page 19-5](#).

## Understanding How the DVS Engine Works

The DVS engine performs anti-malware scanning on URL transactions that are forwarded from the Web Reputation Filters. Web Reputation Filters calculate the probability that a particular URL contains malware, and assign a URL score that is associated with an action to block, scan, or allow the transaction.

When the assigned web reputation score indicates to scan the transaction, the DVS engine receives the URL request and server response content. The DVS engine, in combination with the Webroot and/or Sophos or McAfee scanning engines, returns a malware scanning verdict. The DVS engine uses information from the malware scanning verdicts and Access Policy settings to determine whether to block or deliver the content to the client.

When you enable both Webroot and Sophos or McAfee, the DVS engine determines how to scan the content to optimize performance and efficacy.

## Working with Multiple Malware Verdicts

In some cases, the DVS engine might determine multiple malware verdicts for a single URL. Multiple verdicts can come from one or both enabled scanning engines:

- **Different verdicts from different scanning engines.** When you enable both Webroot and either Sophos or McAfee, each scanning engine might return different malware verdicts for the same object.

- **Different verdicts from the same scanning engine.** A scanning engine might return multiple verdicts for a single object when the object contains multiple infections. For example, a zip file might contain multiple files, each infected with a different kind of malware.

When a URL causes multiple verdicts, the appliance takes different action depending on whether one or both enabled scanning engines return the multiple malware verdicts.

### Different Scanning Engines

When a URL causes multiple verdicts from both enabled scanning engines, the appliance performs the most restrictive action. For example, if one scanning engine returns a block verdict and the other a monitor verdict, the DVS engine always blocks the request. Only the most restrictive verdict is logged and reported.

### Same Scanning Engine

When a URL causes multiple verdicts from the same scanning engine, the appliance takes action according to the verdict with the highest priority. Only the highest verdict is logged and reported. The following text lists the possible malware scanning verdicts from the highest to the lowest priority.

- Virus
- Trojan Downloader
- Trojan Horse
- Trojan Phisher
- Hijacker
- System monitor
- Commercial System Monitor
- Dialer
- Worm
- Browser Helper Object
- Phishing URL
- Adware
- Encrypted file
- Unscannable
- Other Malware

Suppose the McAfee scanning engine detects both adware and a virus in the scanned object, and that the appliance is configured to block adware and monitor viruses. According to the list above, viruses belong in a higher priority verdict category than adware. Therefore, the appliance *monitors* the object and reports the verdict as virus in the reports and logs. It does not block the object even though it is configured to block adware.

## Webroot Scanning

The Webroot scanning engine inspects objects to determine the malware scanning verdict to send to the DVS engine. The Webroot scanning engine inspects the following objects:

- **URL request.** Webroot evaluates a URL request to determine if the URL is a malware suspect. If Webroot suspects the response from this URL might contain malware, the appliance monitors or blocks the request, depending on how the appliance is configured. If Webroot evaluation clears the request, the appliance retrieves the URL and scans the server response.
- **Server response.** When the appliance retrieves a URL, Webroot scans the server response content and compares it to the Webroot signature database.

For more information about how the DVS engine uses malware scanning verdicts to handle web traffic, see [Cisco IronPort DVS™ \(Dynamic Vectoring and Streaming\) Engine, page 19-4](#).

## McAfee Scanning

The McAfee scanning engine inspects objects downloaded from a web server in HTTP responses. After inspecting the object, it passes a malware scanning verdict to the DVS engine so the DVS engine can determine whether to monitor or block the request.

The McAfee scanning engine uses the following methods to determine the malware scanning verdict:

- Matching virus signature patterns
- Heuristic analysis

For more information about how the DVS engine uses malware scanning verdicts to handle web traffic, see [Cisco IronPort DVS™ \(Dynamic Vectoring and Streaming\) Engine, page 19-4](#).

## Matching Virus Signature Patterns

McAfee uses virus definitions in its database with the scanning engine to detect particular viruses, types of viruses, or other potentially unwanted software. It searches for virus signatures in files.

When you enable McAfee, the McAfee scanning engine always uses this method to scan server response content.

## Heuristic Analysis

New threats on the web appear almost daily. Using only virus signatures, the engine cannot detect a new virus or other malware because its signature is not yet known. However, by using heuristic analysis, the McAfee scanning engine can detect new classes of currently unknown viruses and malware in advance.

Heuristic analysis is a technique that uses general rules, rather than specific rules, to detect new viruses and malware. When the McAfee scanning engine uses heuristic analysis, it looks at the code of an object, applies generic rules, and determines how likely the object is to be virus-like.

Using heuristic analysis increases the likelihood of catching viruses and malware before McAfee updates its virus signature database. However, it also increases the possibility of reporting false positives (clean content designated as a virus). It also might impact appliance performance.

When you enable McAfee, you can choose whether or not to also enable heuristic analysis when scanning objects.

## McAfee Categories

Table 19-4 lists the McAfee verdicts and how they correspond to malware scanning verdict categories.

**Table 19-4** *Appliance Categories for McAfee Verdicts*

McAfee Verdict	Malware Scanning Verdict Category
Known Virus	Virus
Trojan	Trojan Horse
Joke File	Adware
Test File	Virus
Wannabe	Virus
Killed	Virus
Commercial Application	Commercial System Monitor
Potentially Unwanted Object	Adware
Potentially Unwanted Software Package	Adware
Encrypted File	Encrypted File

For a list of malware scanning verdicts, see [Malware Scanning Verdict Values, page 24-38](#).

## Sophos Scanning

The Sophos scanning engine inspects objects downloaded from a web server in HTTP responses. After inspecting the object, it passes a malware scanning verdict to the DVS engine so the DVS engine can determine whether to monitor or block the request. You might want to enable the Sophos scanning engine instead of the McAfee scanning engine if the client machines have McAfee anti-malware software installed.

For more information about how the DVS engine uses malware scanning verdicts to handle web traffic, see [Cisco IronPort DVS™ \(Dynamic Vectoring and Streaming\) Engine, page 19-4](#).

## Understanding Adaptive Scanning

Adaptive Scanning is a logic layer that associates web reputation and the content type and decides based on the current threat profile which anti-malware scanning engine will process the web request.

Adaptive Scanning improves efficacy by identifying high-risk content and automatically selecting the best combination of available anti-malware services. Content which is identified as known malware can be automatically blocked. Adaptive Scanning applies the “Outbreak Heuristics” anti-malware category to transactions it identifies as malware prior to running any scanning engines. You can choose whether or not to block these transactions when you configure anti-malware settings on the appliance.

Enabling Adaptive Scanning increases efficacy for filtering out malware, but causes a slight decrease in appliance performance.

To use Adaptive Scanning, you must enable Web Reputation Filters.

When Adaptive Scanning is enabled, the web reputation and anti-malware settings you can configure in Access Policies is slightly different:

- You can enable or disable web reputation filtering in each Access Policy, but you cannot edit the Web Reputation Scores.
- You can enable anti-malware scanning in each Access Policy, but you cannot choose which anti-malware scanning engine to enable. Adaptive Scanning chooses the most appropriate engine for each web request.

**Note**

If Adaptive Scanning is not enabled and an Access Policy has particular web reputation and anti-malware settings configured, and then Adaptive Scanning is enabled, any existing web reputation and anti-malware settings are overridden.

## Enabling Web Reputation and Anti-Malware Filters

The Web Reputation Filters, DVS engine, and the Webroot, McAfee, and Sophos scanning engines are enabled by default during system setup. Anytime after system setup, you can enable web reputation and anti-malware filters and configure global settings.

After the Web Reputation and Anti-Malware Filters are enabled, you can configure web reputation and anti-malware settings in policy groups. For more information, see [Configuring Web Reputation and Anti-Malware in Policies, page 19-10](#).

**Step 1** Navigate to the Security Services > Web Reputation and Anti-Malware page.

**Step 2** Click **Edit Global Settings**.

**Step 3** Configure the web reputation and anti-malware settings as necessary. [Table 19-5](#) describes the settings you can configure.

**Table 19-5** *Web Reputation and Anti-Malware Filter Settings*

Setting	Description
Web Reputation Filtering	Choose whether or not to enable Web Reputation Filtering.
Adaptive Scanning	Choose whether or not to enable Adaptive Scanning. You can only enable Adaptive Scanning when Web Reputation Filtering is enabled. For more information, see <a href="#">Understanding Adaptive Scanning, page 19-8</a> .
Object Scanning Limits	Specify a maximum request/response size. The Maximum Object Size value you specify applies to the entire size of requests and responses that might be scanned by security components on the Web Security appliance, such as the Cisco IronPort Data Security Filters or the Webroot scanning engine. When an upload or download size exceeds this size, the security component may abort the scan in progress and may not provide a scanning verdict to the Web Proxy.
Sophos	Choose whether or not to enable the Sophos scanning engine.

**Table 19-5** Web Reputation and Anti-Malware Filter Settings (continued)

Setting	Description
McAfee	<p>Choose whether or not to enable the McAfee scanning engine.</p> <p>When you enable the McAfee scanning engine, you can choose whether or not to enable heuristic scanning. For more information about heuristic scanning, see <a href="#">McAfee Scanning, page 19-7</a>.</p> <p><b>Note:</b> Heuristic analysis increases security protection, but can result in false positives and decreased performance.</p>
Webroot	<p>Choose whether or not to enable the Webroot scanning engine.</p> <p>When you enable the Webroot scanning engine, you can configure the Threat Risk Threshold (TRT). The TRT assigns a numerical value to the probability that malware exists.</p> <p>Proprietary algorithms evaluate the result of a URL matching sequence and assign a Threat Risk Rating (TRR). This value is associated with the threat risk threshold setting. If the TRR value is greater than or equal to the TRT, the URL is considered malware and is passed on for further processing.</p> <p><b>Note:</b> Setting the Threat Risk Threshold to a value lower than 90 dramatically increases the rate of URL blocking and denies legitimate requests. Cisco strongly recommends maintaining the TRT default value of 90. The minimum value for a TRT setting is 51.</p>

**Step 4** Submit and commit your changes.

## Configuring Web Reputation and Anti-Malware in Policies

When Web Reputation and Anti-Malware Filters are enabled on the appliance, you can configure different settings in policy groups.

You can enable monitoring or blocking for malware categories based on malware scanning verdicts. You can configure anti-malware settings in the following policy groups:

- **Access Policies.** The settings you can configure vary depending on whether or not Adaptive Scanning is enabled. For more information, see [Web Reputation and Anti-Malware Settings in Access Policies, page 19-11](#).
- **Outbound Malware Scanning Policies.** For more information on configuring anti-malware settings in Outbound Malware Scanning Policies, see [Controlling Upload Requests Using Outbound Malware Scanning Policies, page 12-6](#).

You can configure web reputation settings in the following policy groups:

- **Access Policies.** The settings you can configure vary depending on whether or not Adaptive Scanning is enabled. For more information, see [Web Reputation and Anti-Malware Settings in Access Policies, page 19-11](#).
- **Decryption Policies.** For more information, see [Configuring Web Reputation Filter Settings for Decryption Policy Groups, page 19-14](#).

- **Cisco IronPort Data Security Policies.** For more information, see [Configuring Web Reputation Filter Settings for Decryption Policy Groups](#), page 19-14.

## Web Reputation and Anti-Malware Settings in Access Policies

When Adaptive Scanning is enabled, the web reputation and anti-malware settings you can configure for Access Policies are slightly different than when Adaptive Scanning is turned off. For more information, see [Understanding Adaptive Scanning](#), page 19-8.



### Note

If your deployment includes a Security Management appliance, and you are configuring this feature in a Configuration Master, options on this page depend on whether Adaptive Security is enabled for the relevant configuration master. Check the setting on the Security Management appliance, on the Web > Utilities > Security Services Display page.

## Configuring Web Reputation and Anti-Malware Settings with Adaptive Scanning Enabled

- Step 1** Navigate to the Web Security Manager > Access Policies page.
- Step 2** Click the Web Reputation and Anti-Malware Filtering link for the Access Policy you want to configure.
- Step 3** Under the “Web Reputation and Anti-Malware Settings” section, choose Define Web Reputation and Anti-Malware Custom Settings if it is not chosen already.  
  
This allows you to configure web reputation and anti-malware settings for this Access Policy that differ from the global policy.
- Step 4** In the Web Reputation Settings section, choose whether or not to enable Web Reputation Filtering. Adaptive Scanning chooses the most appropriate web reputation score thresholds for each web request.
- Step 5** Scroll down to the Cisco IronPort DVS Anti-Malware Settings section.
- Step 6** Configure the anti-malware settings for the policy as necessary. [Table 19-6](#) describes the anti-malware settings you can configure for Access Policies when Adaptive Scanning is enabled.

**Table 19-6 Anti-Malware Settings for Access Policies—Adaptive Scanning Enabled**

Setting	Description
Enable Suspect User Agent Scanning	Choose whether or not to scan traffic based on the user agent field specified in the HTTP request header.  When you select this checkbox, you can choose to monitor or block suspect user agents in the Additional Scanning section at the bottom of the page.
Enable Anti-Malware Scanning	Choose whether or not to use the DVS engine to scan traffic for malware. Adaptive Scanning chooses the most appropriate engine for each web request.

**Table 19-6** *Anti-Malware Settings for Access Policies—Adaptive Scanning Enabled (continued)*

Setting	Description
Malware Categories	Choose whether to monitor or block the various malware categories based on a malware scanning verdict. For more information on each category, see <a href="#">Malware Category Descriptions, page 19-18</a> .
Other Categories	Choose whether to monitor or block the types of objects and responses listed in this section.  <b>Note:</b> The category Outbreak Heuristics applies to transactions which are identified as malware by Adaptive Scanning prior to running any scanning engines.  <b>Note:</b> URL transactions are categorized as unscannable when the configured maximum time setting is reached or when the system experiences a transient error condition. For example, transactions might be categorized as unscannable during scanning engine updates or AsyncOS upgrades. The malware scanning verdicts SV_TIMEOUT and SV_ERROR, are considered unscannable transactions.

**Step 7** Submit and commit your changes.

## Configuring Web Reputation and Anti-Malware Settings with Adaptive Scanning Disabled

- Step 1** Navigate to the Web Security Manager > Access Policies page.
- Step 2** Click the Web Reputation and Anti-Malware Filtering link for the Access Policy you want to configure.
- Step 3** Under the “Web Reputation and Anti-Malware Settings” section, choose Define Web Reputation and Anti-Malware Custom Settings if it is not chosen already.
- This allows you to configure web reputation and anti-malware settings for this Access Policy that differ from the global policy.
- Step 4** Configure the settings in the Web Reputation Settings section. For more information, see [Configuring Web Reputation Score Thresholds for Access Policies, page 19-13](#).
- Step 5** Scroll down to the Cisco IronPort DVS Anti-Malware Settings section.
- Step 6** Configure the anti-malware settings for the policy as necessary. [Table 19-7](#) describes the anti-malware settings you can configure for Access Policies when Adaptive Scanning is disabled.

**Table 19-7** *Anti-Malware Settings for Access Policies—Adaptive Scanning Disabled*

Setting	Description
Enable Suspect User Agent Scanning	Choose whether or not to enable the appliance to scan traffic based on the user agent field specified in the HTTP request header.  When you select this checkbox, you can choose to monitor or block suspect user agents in the Additional Scanning section at the bottom of the page.
Enable Webroot	Choose whether or not to enable the appliance to use the Webroot scanning engine when scanning traffic. When you enable Webroot scanning, you can choose to monitor or block some additional categories in the Malware categories on this page.



**Table 19-7** *Anti-Malware Settings for Access Policies—Adaptive Scanning Disabled (continued)*

Setting	Description
Enable Sophos or McAfee	Choose whether or not to enable the appliance to use either the Sophos or McAfee scanning engine when scanning traffic. When you enable Sophos or McAfee scanning, you can choose to monitor or block some additional categories in the Malware categories on this page.
Malware Categories	Choose whether to monitor or block the various malware categories based on a malware scanning verdict.  The categories listed in this section depend on which scanning engines you enable above. For more information on each category, see <a href="#">Malware Category Descriptions, page 19-18</a> .
Other Categories	Choose whether to monitor or block the types of objects and responses listed in this section.  <b>Note</b> URL transactions are categorized as unscannable when the configured maximum time setting is reached or when the system experiences a transient error condition. For example, transactions might be categorized as unscannable during scanning engine updates or AsyncOS upgrades. The malware scanning verdicts SV_TIMEOUT and SV_ERROR, are considered unscannable transactions.

**Step 7** Submit and commit your changes.

## Configuring Web Reputation Scores

When you install and set up the Web Security appliance, it has default settings for Web Reputation Scores. However, you can modify threshold settings for web reputation scoring to fit your organization's needs.

You configure the web reputation filter settings for each policy group.

### Configuring Web Reputation Score Thresholds for Access Policies

You can edit the web reputation score thresholds in Access Policies when Adaptive Scanning is disabled.

- 
- Step 1** Navigate to the Web Security Manager > Access Policies page.
  - Step 2** Click the link under the Web Reputation and Anti-Malware Filtering column for the Access Policy group you want to edit.
  - Step 3** Under the Web Reputation and Anti-Malware Settings section, choose “Define Web Reputation and Anti-Malware Custom Settings” from the drop down menu if it is not selected already.

This allows you to configure web reputation and anti-malware settings for this Access Policy that differ from the global policy.

**Figure 19-1 Web Reputation Filter Settings for Access Policies**

Access Policies: Reputation and Anti-Malware Settings: example1policy

Web Reputation and Anti-Malware Settings

Define Web Reputation and Anti-Malware Custom Settings

Web Reputation Settings

Enable Web Reputation Filtering

Web Reputation Score

BLOCK	SCAN	ALLOW
-10.0 to -6.0	-5.9 to 5.9	6.0 to 10.0

Block	Scan	Allow
The requested URL is immediately blocked.	The IronPort DVS™ engine scans the client request and the server response. Note: Sites with no score will be scanned.	The requested URL is allowed. No scanning is performed.

Move these markers to change the Web Reputation threshold values.

- Step 4** Verify the Enable Web Reputation Filtering field is enabled.
- Step 5** Move the markers to change the range for URL block, scan, and allow actions.
- Step 6** Submit and commit your changes.

## Configuring Web Reputation Filter Settings for Decryption Policy Groups

- Step 1** Navigate to the Web Security Manager > Decryption Policies page.
- Step 2** Click the link under the Web Reputation column for the Decryption Policy group you want to edit.
- Step 3** Under the Web Reputation Settings section, choose “Define Web Reputation Custom Settings” from the drop down menu if it is not selected already. This allows you to override the web reputation settings from the Global Policy Group.

**Figure 19-2** Web Reputation Filter Settings for Decryption Policies

## HTTPS Decryption Policies: Reputation Settings: exampleDecryptionGroup

**Web Reputation Settings**  
Define Web Reputation Custom Settings

**Web Reputation Settings**  
 Enable Web Reputation Filtering

**Web Reputation Score**

DROP	DECRYPT	PASS THROUGH
-10.0 to -9.0	-8.9 to 5.9	6.0 to 10.0

Drop	Decrypt	Pass Through
The requested HTTPS connection is immediately dropped. No end-user notification will be provided. Use this setting with caution.	The HTTPS transaction will be decrypted for scanning and re-encrypted to ensure user privacy and security. The scanning defined in the applicable Web Access Policy will be performed.	The HTTPS request is passed through without decryption. No scanning will be performed.

**Sites with No Score**  
Specify an action for sites that do not have a Web Reputation Score.

Sites with No Score: Use Global Settings (Monitor)

Move these markers to change the Web Reputation threshold values.

Choose action for sites with no assigned Web Reputation Score.

- Step 4** Verify the Enable Web Reputation Filtering field is checked.
- Step 5** Move the markers to change the range for URL drop, decrypt, and pass through actions.
- Step 6** In the Sites with No Score field, choose the action to take on request for sites that have no assigned Web Reputation Score.
- Step 7** Submit and commit your changes.

## Configuring Web Reputation Filter Settings for Data Security Policy Groups

Only negative and zero values can be configured for web reputation threshold settings for Cisco IronPort Data Security Policies. By definition, all positive scores are monitored.

- Step 1** Navigate to the Web Security Manager > Cisco IronPort Data Security page.
- Step 2** Click the link under the Web Reputation column for the Data Security Policy group you want to edit.
- Step 3** Under the Web Reputation Settings section, choose “Define Web Reputation Custom Settings” from the drop down menu if it is not selected already.

**Figure 19-3** Web Reputation Filter Settings for Cisco IronPort Data Security Policies

Ironport Data Security Policies: Reputation Settings: IDSPolicy1

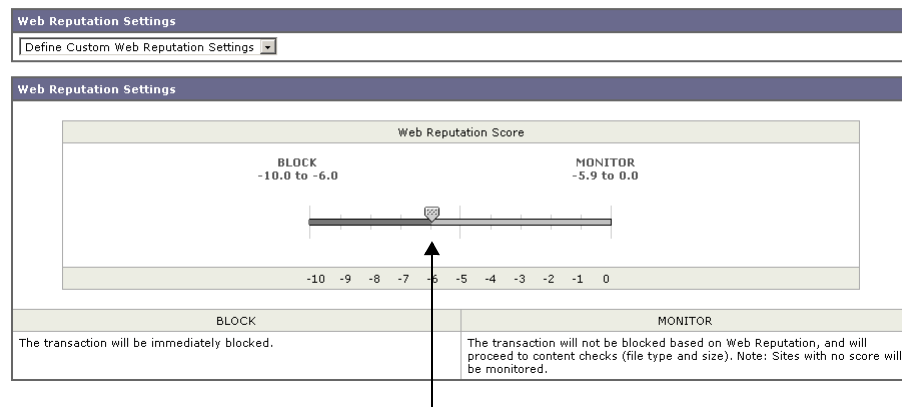

Move the marker to change the Web Reputation threshold value.

This allows you to override the web reputation settings from the Global Policy Group.

- Step 4** Move the marker to change the range for URL block and monitor actions.  
 For more information on these actions, see [Data Security Policy Groups, page 13-3](#).
- Step 5** Submit and commit your changes.

## Maintaining the Database Tables

The web reputation, Webroot, Sophos, and McAfee databases periodically receive updates from the Cisco IronPort update server (<https://update-manifests.ironport.com>). Server updates are automated, and the update interval is set by the server, not the appliance. Updates to the database tables occur automatically with no administrator intervention.

For information about update intervals and the Cisco IronPort update server, see [Manually Updating Security Service Components, page 26-41](#).

## The Web Reputation Database

The Web Security appliance collects information and maintains a filtering database that contains aggregated traffic statistics, request attributes, and information about how different types of requests are handled. Additionally, the appliance can be configured to send web reputation statistics to a Cisco SensorBase Network server. SensorBase server information is leveraged with data feeds from the SensorBase Network and the collective information is used to produce a Web Reputation Score.



### Note

For more information, see [Participating in The Cisco SensorBase Network, page 2-11](#).

## Logging

The access log file records the information returned by the Web Reputation Filters and the DVS engine for each transaction. The scanning verdict information section in the access logs includes many fields to help understand the cause for the action applied to a transaction. For example, some fields display the web reputation score or the malware scanning verdict Sophos passed to the DVS engine.

For more information about the scanning verdict information section in the access log file, see [Understanding Scanning Verdict Information, page 24-21](#).

For more information about reading access log files, see [Access Log File, page 24-14](#). For more an example access log entry that explains web reputation processing, see [Web Reputation Filters Example, page 24-25](#).

## Logging Adaptive Scanning

When Adaptive Scanning is enabled, you can use the fields in [Table 19-8](#) to learn more information about how the adaptive scanning engine affected transactions.

**Table 19-8 Adaptive Scanning Logging Information**

Custom Field in Access Logs	Custom Field in W3C Logs	Description
%X6	x-as-malware-threat-name	The anti-malware name returned by Adaptive Scanning. If the transaction is not blocked, this field returns a hyphen (“-”).  This variable is included in the scanning verdict information (in the angled brackets at the end of each access log entry).

Transactions blocked and monitored by the adaptive scanning engine use the following ACL decision tags:

- BLOCK\_AMW\_RESP
- MONITOR\_AMW\_RESP

## Caching

Notes about how AsyncOS use the cache while scanning for malware:

- AsyncOS only caches objects if the entire object downloads. If malware is blocked during scanning, the whole object is not downloaded and therefore is not cached.
- AsyncOS scans content whether it is retrieved from the server or from the web cache.
- The length of time that content is cached varies with many factors -- there is no default.
- AsyncOS rescans content when signatures are updated.

# Malware Category Descriptions

Table 19-9 describes the different categories of malware the Web Security appliance can block.

**Table 19-9 Malware Category Descriptions**

Malware Type	Description
Adware	Adware encompasses all software executables and plug-ins that direct users towards products for sale. Some adware applications have separate processes that run concurrently and monitor each other, ensuring that the modifications are permanent. Some variants enable themselves to run each time the machine is started. These programs may also change security settings making it impossible for users to make changes to their browser search options, desktop, and other system settings.
Browser Helper Object	A browser helper object is a browser plug-in that may perform a variety of functions related to serving advertisements or hijacking user settings.
Commercial System Monitor	A commercial system monitor is a piece of software with system monitor characteristics that can be obtained with a legitimate license through legal means.
Dialer	A dialer is a program that utilizes your modem or another type of Internet access to connect you to a phone line or a site that causes you to accrue long distance charges to which you did not provide your full, meaningful, and informed consent.
Generic Spyware	Spyware is a type of malware installed on computers that collects small pieces of information about users without their knowledge.
Hijacker	A hijacker modifies system settings or any unwanted changes to a user's system that may direct them to a website or run a program without a user's full, meaningful, and informed consent.
Other Malware	This category is used to catch all other malware and suspicious behavior that does not exactly fit in one of the other defined categories.
Phishing URL	A phishing URL is displayed in the browser address bar. In some cases, it involves the use of domain names and resembles those of legitimate domains. Phishing is a form of online identity theft that employs both social engineering and technical subterfuge to steal personal identity data and financial account credentials.
PUA	Potentially Unwanted Application. A PUA is an application that is not malicious, but which may be considered to be undesirable.
System Monitor	A system monitor encompasses any software that performs one of the following actions: <ul style="list-style-type: none"> <li>• Overtly or covertly records system processes and/or user action.</li> <li>• Makes those records available for retrieval and review at a later time.</li> </ul>
Trojan Downloader	A trojan downloader is a Trojan that, after installation, contacts a remote host/site and installs packages or affiliates from the remote host. These installations usually occur without the user's knowledge. Additionally, a Trojan Downloader's payload may differ from installation to installation since it obtains downloading instructions from the remote host/site.

**Table 19-9 Malware Category Descriptions (continued)**

<b>Malware Type</b>	<b>Description</b>
Trojan Horse	A trojan horse is a destructive program that masquerades as a benign application. Unlike viruses, Trojan horses do not replicate themselves.
Trojan Phisher	A trojan phisher may sit on an infected computer waiting for a specific web page to be visited or may scan the infected machine looking for user names and passwords for bank sites, auction sites, or online payment sites.
Virus	A virus is a program or piece of code that is loaded onto your computer without your knowledge and runs against your wishes.
Worm	A worm is program or algorithm that replicates itself over a computer network and usually performs malicious actions.





# 20

## Authentication

---

- [Overview of Authentication, page 20-1](#)
- [Understanding How Authentication Works, page 20-4](#)
- [Authentication Realms, page 20-10](#)
- [Working with Authentication Sequences, page 20-15](#)
- [Appliance Behavior with Multiple Authentication Realms, page 20-16](#)
- [Authentication Realm Testing, page 20-17](#)
- [Configuring Global Authentication Settings, page 20-18](#)
- [Sending Authentication Credentials Securely, page 20-23](#)
- [Allowing Users to Re-Authenticate, page 20-25](#)
- [Tracking Authenticated Users, page 20-27](#)
- [Bypassing Authentication, page 20-28](#)
- [LDAP Authentication, page 20-28](#)
- [NTLM Authentication, page 20-31](#)
- [Supported Authentication Characters, page 20-32](#)

## Overview of Authentication

Authentication is the act of confirming the identity of a user. By using authentication in the Web Security appliance, you can control access to the Web for each user or a group of users. This allows you to enforce the organization's policies and comply with regulations. When you enable authentication, the Web Security appliance authenticates clients on the network before allowing them to connect to a destination server.

The Web Security appliance supports the following authentication protocols:

- **Lightweight Directory Access Protocol (LDAP).** The appliance supports standard LDAP server authentication and secure LDAP authentication. You can use a Basic authentication scheme. For more information about LDAP configuration options, see [LDAP Authentication, page 20-28](#).
- **NT Lan Manager (NTLM).** The appliance supports NTLM to enable authentication between the appliance and a Microsoft Windows domain controller. You can use either NTLMSSP or Basic authentication schemes. For more information about NTLM configuration options, see [NTLM Authentication, page 20-31](#).

To enable authentication, you must create at least one authentication realm. An authentication realm is a set of authentication servers (or a single server) supporting a single authentication protocol with a particular configuration. For more information about authentication realms, see [Authentication Realms, page 20-10](#).

When you create more than one realm, you can group the realms into an authentication sequence. An authentication sequence is a group of authentication realms listed in the order the Web Security appliance uses for authenticating clients. For more information about authentication sequences, see [Working with Authentication Sequences, page 20-15](#).

You configure some authentication options at a global level, independent of any realm. For more information, see [Configuring Global Authentication Settings, page 20-18](#).

By creating authentication realms and sequences, you can configure the Web Security appliance to use one or more authentication servers for authenticating clients on the network. For more information about how the appliance works when it uses multiple authentication servers, see [Appliance Behavior with Multiple Authentication Realms, page 20-16](#).

After creating an authentication realm and possibly a sequence, too, you can create or edit Identities based on authentication realms or sequences. Note, however, that if you delete an authentication realm or sequence, any Identity group that depends on the deleted realm or sequence becomes disabled. For more information about using authentication with Identities, see [Understanding How Authentication Affects Identity Groups, page 8-5](#).

## Client Application Support

When the Web Security appliance is deployed in transparent mode and a transaction requires authentication, the Web Proxy replies to the client application asking for authentication credentials. However, not all client applications support authentication, so they have no method for prompting users to provide their user names and passwords. These applications cannot be used when the Web Security appliance is deployed in transparent mode.

The following is a partial list of applications that do not work when the appliance is deployed in transparent mode:

- Mozilla Thunderbird
- Adobe Acrobat Updates
- HttpBridge
- Subversion, by CollabNet
- Microsoft Windows Update
- Microsoft Visual Studio

**Note**

---

If users need to access a particular URL using one of these client applications, then create an Identity based on a custom URL category that does not require authentication and place the Identity above all other Identities that require authentication. When you do this, the client application will not be asked for authentication.

---

## Working with Upstream Proxy Servers

You can connect the Web Security appliance to an upstream proxy server. The upstream proxy server might be another Web Security appliance or a third party proxy. When the Web Security appliance is connected to an upstream proxy server, whether or not you can enable authentication depends on the authentication type:

- **NTLMSSP.** When NTLMSSP authentication is used to authenticate users, you should only enable authentication on either the Web Security appliance or the upstream proxy server, but not both. Cisco recommends configuring the Web Security appliance to use authentication. This allows you to create policies based on user authentication.

If both the appliance and the upstream proxy use authentication with NTLMSSP, depending on the configurations, the appliance and upstream proxy might engage in an infinite loop of requesting authentication credentials. For example, if the upstream proxy requires Basic authentication, but the appliance requires NTLMSSP authentication, then the appliance can never successfully pass Basic credentials to the upstream proxy. This is due to limitations in authentication protocols.

- **Basic.** When Basic authentication is used to authenticate users, you can enable authentication on either the appliance or upstream proxy server, or on both the appliance and upstream proxy server. However, when both the Web Security appliance and upstream proxy server use Basic authentication, do not enable the Credential Encryption feature on the downstream Web Security appliance. When Credential Encryption is enabled on the downstream appliance, client requests fail because the Web Proxy receives a “Authorization” HTTP header from clients, but the upstream proxy server requires a “Proxy-Authorization” HTTP header.

## Authenticating Users

When users access the web through the Web Security appliance, they might get prompted to enter a user name and password. The Web Proxy requires authentication credentials for some users depending on the configured Identity and Access Policy groups. Users should enter the user name and password of the credentials recognized by the organization’s authentication server.

When the Web Proxy uses NTLMSSP authentication with an NTLM authentication realm, users are typically not prompted to enter a user name and password if single sign-on is configured correctly. However, if users are prompted for authentication, they must type the name of their Windows domain before their user name. For example, if user jsmith is on Windows domain MyDomain, then the user should type the following text in the user name field:

```
MyDomain\jsmith
```

However, if the Web Proxy uses Basic authentication for an NTLM authentication realm, then entering the Windows domain is optional. If the user does not enter the Windows domain, then the Web Proxy prepends the default Windows domain.



### Note

---

When the Web Proxy uses authentication with an LDAP authentication realm, ensure users do not enter the Windows domain name.

---

## Working with Failed Authentication

Sometimes users are blocked from the web due to authentication failure. The following list describes reasons for authentication failure and remedial actions you can take:

- **Client application cannot perform authentication.** Some clients cannot perform authentication or cannot perform the type of authentication that is required. If a client application causes authentication to fail, you can define an Identity policy based on the user agent and exclude it from requiring authentication. Or, you can define an Identity policy based on a custom URL category to exclude all clients from requiring authentication when accessing particular URLs.

- **Authentication server is unavailable.** An authentication server might be unavailable if the network connection is broken or if the server is experiencing a problem. To avoid this problem, configure the “Action if Authentication Service Unavailable” global authentication setting. For more information, see [Configuring Global Authentication Settings, page 20-18](#).
- **Invalid credentials.** When a client passes invalid authentication credentials, the Web Proxy continually requests valid credentials, essentially blocking access to the web by default. However, you can grant limited access to users who fail authentication. For more information, see [Allowing Guest Access to Users Who Fail Authentication, page 8-10](#).

**Note**

You can configure the Web Proxy to request authentication again if an authenticated user is blocked from a website due to restrictive URL filtering or being prevented from logging into multiple machines simultaneously. To do this, enable the “Enable Re-Authentication Prompt If End User Blocked by URL Category or User Session Restriction” global authentication setting. For more information, see [Allowing Users to Re-Authenticate, page 20-25](#).

## Working with Windows 7 and Windows Vista

Windows 7 and Windows Vista machines have a feature called Network Connectivity Status Indicator (NCSI). When clients on your network use NCSI and the Web Security appliance uses NTLMSSP authentication, you should configure the appliance so it uses a relatively small timeout value for machine credentials. Do this using the `advancedproxyconfig > authentication` CLI command:

```
Enter the surrogate timeout for machine credentials.
```

When NCSI is running on a Windows machine, it checks for network connectivity by making HTTP requests. When the machine running NCSI is prompted to authenticate (the request is assigned an Identity Policy that requires authentication), NCSI authenticates using the machine’s credentials instead of the user’s credentials.

When the Identity Policy uses IP based surrogates, subsequent requests from the user might be assigned an incorrect Access Policy as the user would be identified using the machine credentials instead of the user’s own credentials.

You can use the `advancedproxyconfig > authentication` CLI command to specify how long the IP address surrogate is used for machine credentials before requiring authentication again. The Web Proxy differentiates between user and machine credentials.

## Understanding How Authentication Works

To authenticate users who access the web, the Web Security appliance connects to an external authentication server. The authentication server contains a list of users and their corresponding passwords and it organizes the users into a hierarchy. For users on the network to successfully authenticate, they must provide valid authentication credentials (user name and password as stored in the authentication server).

When users access the web through a Web Security appliance that requires authentication, the Web Proxy asks the client for authentication credentials. The Web Proxy communicates with both the client and the authentication server to authenticate the user and process the request.

[Figure 20-1](#) shows how the Web Security appliance communicates with clients and authentication servers.

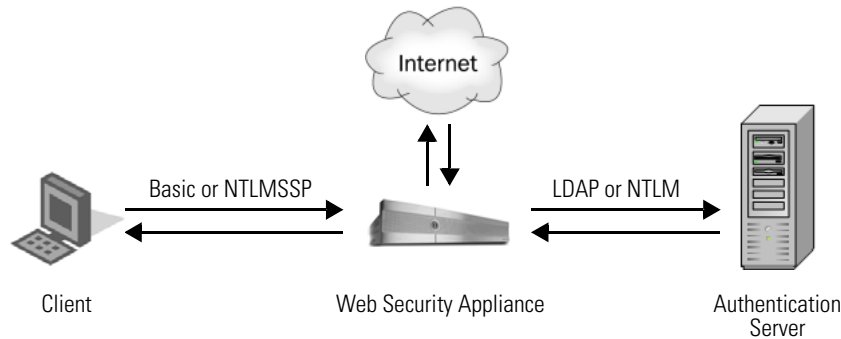
**Figure 20-1 Web Security Appliance Authentication**

The Web Security appliance supports the following authentication protocols:

- **Lightweight Directory Access Protocol (LDAP).** The Web Proxy uses the LDAP Bind operation to query an LDAP-compatible authentication server. The appliance supports standard LDAP server authentication and secure LDAP authentication.

For more information about LDAP configuration options, see [LDAP Authentication, page 20-28](#).

- **NT LAN Manager (NTLM).** The Web Proxy uses NTLM, a Microsoft proprietary protocol, to authenticate users which exist in Microsoft Active Directory. The NTLM protocol uses a challenge-response sequence of messages between the client and the Active Directory server. You can use either NTLMSSP or Basic authentication schemes on client side.

For more information about NTLM configuration options, see [NTLM Authentication, page 20-31](#).

In addition to the preceding protocols, the Web Security appliance supports the following client side authentication schemes:

- **Basic.** Allows a client application to provide authentication credentials in the form of a user name and password when it makes a request. You can use the Basic authentication scheme with either an LDAP or Active Directory server.
- **NTLMSSP.** Allows the client application to provide authentication credentials in the form of a challenge and response. It uses a binary message format to authenticate clients that use the NTLM protocol to access network resources. You can use the NTLMSSP authentication scheme only with an Active Directory server. When the Web Proxy uses NTLMSSP, most client applications can use the Windows login credentials for authentication and users do not need to enter their credentials again. This is called “single sign-on.”

For more information, see [Basic versus NTLMSSP Authentication Schemes, page 20-6](#).

[Table 20-1](#) describes the different authentication scenarios you can configure between the Web Security appliance and the client and between the Web Security appliance and the authentication server.

**Table 20-1 Web Security Appliance Authentication Scenarios**

Client to Web Security Appliance	Web Security Appliance to Authentication Server	Authentication Server Type
Basic	LDAP	LDAP server
Basic	LDAP	Active Directory server using LDAP
Basic	NTLM	Active Directory server using NTLM
NTLMSSP	NTLM	Active Directory server using NTLM

Web Proxy deployment also affects how authentication works in each of the scenarios described in [Table 20-1](#). For more information, see [How Web Proxy Deployment Affects Authentication, page 20-6](#).

## Basic versus NTLMSSP Authentication Schemes

When you configure an Identity group to use authentication, you choose the authentication scheme, either Basic or NTLMSSP. The authentication scheme affects the user experience and the security of users' passwords.

[Table 20-2](#) describes the differences between Basic and NTLMSSP authentication schemes.

**Table 20-2** *Basic versus NTLMSSP Authentication Schemes*

Authentication Scheme	User Experience	Security
Basic	The client always prompts users for credentials. After the user enters credentials, browsers typically offer a check box to remember the provided credentials. Each time the user opens the browser, the client either prompts for credentials or resends the previously saved credentials.	Credentials are sent <i>unsecured</i> as clear text (Base64). A packet capture between the client and Web Security appliance can reveal the user name and password.  <b>Note:</b> You can configure the Web Security appliance so clients send authentication credentials securely. For more information, see <a href="#">Sending Authentication Credentials Securely, page 20-23</a> .
NTLMSSP	The client transparently authenticates by using its Windows login credentials. The user is not prompted for credentials.  However, the client prompts the user for credentials under the following circumstances: <ul style="list-style-type: none"> <li>• The Windows credentials failed.</li> <li>• The client does not trust the Web Security appliance because of browser security settings.</li> </ul>	Credentials are sent <i>securely</i> using a three-way handshake (digest style authentication). The password is never sent across the connection.  For more information on the three-way handshake, see <a href="#">Explicit Forward Deployment, NTLM Authentication, page 20-8</a> .

## How Web Proxy Deployment Affects Authentication

The Web Proxy communicates with clients and authentication servers differently depending on the type of Web Proxy deployment and the authentication protocol.

[Table 20-3](#) lists the possible methods of authentication for the various authentication protocols and deployment type.

**Table 20-3** *Methods of Authentication*

Web Proxy Deployment	Client to Web Security Appliance	Web Security Appliance to Authentication Server
Explicit forward	Basic	LDAP or NTLM Basic
Transparent	Basic	LDAP or NTLM Basic

**Table 20-3** *Methods of Authentication (continued)*

Web Proxy Deployment	Client to Web Security Appliance	Web Security Appliance to Authentication Server
Explicit forward	NTLM	NTLMSSP
Transparent	NTLM	NTLMSSP

The following subsections describe these methods of authentication in more detail.

## Explicit Forward Deployment, Basic Authentication

When a client explicitly sends a web page request to a Web Security appliance deployed in explicit forward mode, the Web Proxy can reply to the client with a 407 HTTP response “Proxy Authentication Required.” This status informs the client that it must supply valid authentication credentials to access web resources.

The authentication process comprises these steps:

1. Client sends a request to the Web Proxy to connect to a web page.
2. Web Proxy responds with a 407 HTTP response “Proxy Authentication Required.”
3. User enters credentials, and client application resends the original request with the credentials encoded in Base64 (not encrypted) in a “Proxy-Authorization” HTTP header.
4. Web Proxy verifies the credentials and returns the requested web page.

Table 20-4 lists advantages and disadvantages of using explicit forward Basic authentication.

**Table 20-4** *Pros and Cons of Explicit Forward Basic Authentication*

Advantages	Disadvantages
<ul style="list-style-type: none"> <li>• RFC-based</li> <li>• Supported by all browsers and most other applications</li> <li>• Minimal overhead</li> <li>• Works for HTTPS (CONNECT) requests</li> </ul>	<ul style="list-style-type: none"> <li>• Password sent as clear text (Base64) for every request</li> <li>• No single sign-on</li> </ul>

## Transparent Deployment, Basic Authentication

The 407 HTTP response “Proxy Authentication Required” is allowed from proxy servers only. However, when the Web Proxy is deployed in transparent mode, its existence is hidden from client applications on the network. Therefore, the Web Proxy cannot return a 407 response.

To address this problem, the authentication process comprises these steps:

1. Client sends a request to a web page and the Web Proxy transparently intercepts it.
2. Web Proxy uses a 307 HTTP response to redirect the client to the Web Proxy which masquerades as a local web server.



**Note** This transaction is recorded in the access logs with “TCP\_DENIED/307”.

3. Client sends a request to the redirected URL.

4. Web Proxy sends a 401 HTTP response “Authorization required.”
5. User is prompted for credentials and enters them.
6. Client sends the request again, but this time with the credentials in an “Authorization” HTTP header.
7. Web Proxy confirms the credentials, tracks the user by IP address or with a cookie, and then redirects the client to the originally requested server.



**Note** You can configure the Web Proxy to use either IP addresses or cookies to track authenticated users.

8. If the client requests the original web page again, the Web Proxy transparently intercepts the request, confirms the user by IP address or cookie, and returns the requested page.



**Note**

If the client tries to connect to another web page and the Web Proxy tracked the user by IP address, the Web Proxy confirms the user by IP address and returns the requested page.

Table 20-5 lists advantages and disadvantages of using transparent Basic authentication and IP-based credential caching.

**Table 20-5** *Pros and Cons of Transparent Basic Authentication—IP Caching*

Advantages	Disadvantages
<ul style="list-style-type: none"> <li>• Works with all major browsers</li> <li>• With user agents that do not support authentication, users only need to authenticate first in a supported browser</li> <li>• Relatively low overhead</li> <li>• Works for HTTPS requests if the user has previously authenticated with an HTTP request</li> </ul>	<ul style="list-style-type: none"> <li>• Authentication credentials are associated with the IP address, not the user (does not work in Citrix and RDP environments, or if the user changes IP address)</li> <li>• No single sign-on</li> <li>• Password is sent as clear text (Base64)</li> </ul>

Table 20-6 lists advantages and disadvantages of using transparent Basic authentication and cookie-based credential caching.

**Table 20-6** *Pros and Cons of Transparent Basic Authentication—Cookie Caching*

Advantages	Disadvantages
<ul style="list-style-type: none"> <li>• Works with all major browsers</li> <li>• Authentication is associated with the user rather than the host or IP address</li> </ul>	<ul style="list-style-type: none"> <li>• Each new web domain requires the entire authentication process because cookies are domain specific</li> <li>• Requires cookies to be enabled</li> <li>• Does not work for HTTPS requests</li> <li>• No single sign-on</li> <li>• Password is sent as clear text (Base64)</li> </ul>

## Explicit Forward Deployment, NTLM Authentication

The Web Proxy uses a third party challenge and response system to authenticate users on the network.



The authentication process comprises these steps:

1. Client sends a request to the Web Proxy to connect to a web page.
2. Web Proxy responds with a 407 HTTP response “Proxy Authentication Required.”
3. Client repeats request and includes a “Proxy-Authorization” HTTP header with an NTLM “negotiate” message.
4. Web Proxy responds with a 407 HTTP response and an NTLM “challenge” message based on the negotiate message from the client.
5. Client repeats the request and includes a response to the challenge message.



**Note** The client uses an algorithm based on its password to modify the challenge and sends the challenge response to the Web Proxy.

6. Web Proxy passes the authentication information to the Active Directory server. The Active Directory server then verifies that the client used the correct password based on whether or not it modified the challenge string appropriately.
7. If the challenge response passes, the Web Proxy returns the requested web page.



**Note**

Additional requests *on the same TCP connection* do not need to be authenticated again with the Active Directory server.

Table 20-7 lists advantages and disadvantages of using explicit forward NTLM authentication.

**Table 20-7** Pros and Cons of Explicit Forward NTLM Authentication

Advantages	Disadvantages
<ul style="list-style-type: none"> <li>• Because the password is not transmitted to the authentication server, it is more secure</li> <li>• Connection is authenticated, not the host or IP address</li> <li>• Achieves true single sign-on in an Active Directory environment when the client applications are configured to trust the Web Security appliance</li> </ul>	<ul style="list-style-type: none"> <li>• Moderate overhead: each new connection needs to be re-authenticated</li> <li>• Primarily supported on Windows only and with major browsers only</li> </ul>

## Transparent Deployment, NTLM Authentication

Transparent NTLM authentication is similar to transparent Basic authentication except that the Web Proxy communicates with clients using NTLMSSP instead of Basic. However, with transparent NTLM authentication, the authentication credentials are not sent in the clear to the authentication server.

For more information, see [Transparent Deployment, Basic Authentication, page 20-7](#).

The advantages and disadvantages of using transparent NTLM authentication are the same as those of using transparent Basic authentication except that transparent NTLM authentication is better because the password is not sent to the authentication server and you can achieve single sign-on when the client applications are configured to trust the Web Security appliance. For more information on the advantages and disadvantages of transparent Basic authentication, see [Table 20-5 on page 20-8](#) [Table 20-6 on page 20-8](#).

# Authentication Realms

An authentication realm is a set of authentication servers (or a single server) supporting a single authentication protocol with a particular configuration.

You can perform any of the following tasks when configuring authentication:

- Include up to three authentication servers in a realm.
- Create zero or more LDAP realms.
- Create between zero and 10 NTLM realms.
- Include an authentication server in multiple realms.
- Include one or more realms in an authentication sequence.
- Include realms of different protocols in a single authentication sequence, but only one NTLM realm can use NTLMSSP in the sequence.
- Assign a realm or a sequence to an Identity group.

You create, edit, and delete authentication realms on the Network > Authentication page under the Authentication Realms section.

When you create two or more realms, you can order them in an authentication sequence. For more information, see [Working with Authentication Sequences, page 20-15](#).

## Adding an LDAP Authentication Realm

---

**Step 1** Navigate to **Network > Authentication**.

**Step 2** Click **Add Realm**.

**Step 3** Name the authentication realm.

All sequence and realm names must be unique and only contain alphanumeric characters or the space character. Also, if the Web Security appliance is managed by a Security Management appliance, ensure that same-named authentication realms on different Web Security appliances have identical properties defined on each appliance.

**Step 4** Select **LDAP** in the Authentication Protocol and Scheme(s) field.

**Step 5** Enter the LDAP authentication settings:

Setting	Description
LDAP Version	<p>Choose the version of LDAP, and choose whether or not to use Secure LDAP. The appliance supports LDAP versions 2 and 3. Secure LDAP requires LDAP version 3.</p> <p>Choose whether or not this LDAP server supports Novell eDirectory to use with transparent user identification.</p>
LDAP Server	<p>Enter the LDAP server IP address or hostname and its port number. You can specify up to three servers.</p> <p>The hostname must be a fully-qualified domain name. For example, <code>ldap.example.com</code>. An IP address is required only if the DNS servers configured on the appliance cannot resolve the LDAP server hostname.</p> <p>The default port number for Standard LDAP is 389. The default number for Secure LDAP is 636.</p> <p>If the LDAP server is an Active Directory server, enter the hostname or IP address and the port of the domain controller here. Whenever possible, enter the name of the Global Catalog Server and use port 3268. However, you might want to use a local domain controller when the global catalog server is physically far away and you know you only need to authenticate users on the local domain controller.</p> <p><b>Note:</b> When you configure multiple authentication servers in the realm, the appliance attempts to authorize with up to three authentication servers before failing to authenticate the transaction within that realm.</p>
LDAP Persistent Connections (under the Advanced section)	<p>Choose one of the following values:</p> <ul style="list-style-type: none"> <li>• <b>Use persistent connections (unlimited).</b> Use existing connections. If no connections are available a new connection is opened.</li> <li>• <b>Use persistent connections.</b> Use existing connections to service the number of requests specified. When the maximum is reached, establish a new connection to the LDAP server.</li> <li>• <b>Do not use persistent connections.</b> Always create a new connection to the LDAP server.</li> </ul>

Setting	Description
User Authentication	<p>Enter values for the following fields:</p> <p><b>Base Distinguished Name (Base DN)</b></p> <p>The LDAP database is a tree-type directory structure and the appliance uses the Base DN to navigate to the correct location in the LDAP directory tree to begin a search. A valid Base DN filter string is composed of one or more components of the form <code>object-value</code>. For example <code>dc=companyname, dc=com</code>.</p> <p><b>User Name Attribute</b></p> <p>Choose one of the following values:</p> <ul style="list-style-type: none"> <li>• <b>uid, cn, and sAMAccountName.</b> Unique identifiers in the LDAP directory that specify a username.</li> <li>• <b>custom.</b> A custom identifier such as <code>UserAccount</code>.</li> </ul> <p><b>User Filter Query</b></p> <p>The User Filter Query is an LDAP search filter that locates the users Base DN. This is required if the user directory is in a hierarchy below the Base DN, or if the login name is not included in the user-specific component of that users Base DN.</p> <p>Choose one of the following values:</p> <ul style="list-style-type: none"> <li>• <b>none.</b> Filters any user.</li> <li>• <b>custom.</b> Filters a particular group of users.</li> </ul>
Query Credentials	<p>Choose whether or not the authentication server accepts anonymous queries.</p> <p>If the authentication server does accept anonymous queries, choose Server Accepts Anonymous Queries.</p> <p>If the authentication server does not accept anonymous queries, choose Use Bind DN and then enter the following information:</p> <ul style="list-style-type: none"> <li>• <b>Bind DN.</b> The user on the external LDAP server permitted to search the LDAP directory. Typically, the bind DN should be permitted to search the entire directory.</li> <li>• <b>Password.</b> The password associated with the user you enter in the Bind DN field.</li> </ul> <p>The following text lists some example users for the Bind DN field:</p> <pre>cn=administrator,cn=Users,dc=domain,dc=com sAMAccountName=jdoe,cn=Users,dc=domain,dc=com.</pre> <p>If the Active Directory server is used as an LDAP server, you may also enter the Bind DN username as "DOMAIN\username."</p>
Group Authorization	<p>Choose whether or not to enable LDAP group authorization. When you enable LDAP group authorization, you can group users by group object or user object.</p>

**Step 6** Click **Start Test**.

**Step 7** Submit and commit your changes.

**Related Topics**

- [Identifying Users Transparently, page 8-12](#)
- [LDAP Group Authorization, page 20-29](#)
- [Authentication Realm Testing, page 20-17.](#)

## Adding an NTLM Authentication Realm

**Before You Begin**

- Compare the current time reading on the Web Security appliance with the current time reading on the Active Directory server. Verify that the difference is no greater than the time specified in the “Maximum tolerance for computer clock synchronization” option on the Active Directory server. When you use Network Time Protocol (NTP) to specify the current time on the Web Security appliance, the default time server is `time.ironport.com`.
- If the network uses NetBIOS, use the `setntlmsecuritymode` CLI command to verify that the NTLM security mode is set to “domain”. Otherwise, you will not have the opportunity to provide the NetBIOS domain name.
- If you plan to configure transparent user identification using Active Directory agent, verify that Active Directory agent is installed on at least one computer that can access the Active Directory server.

---

**Step 1** Navigate to **Network > Authentication**.

**Step 2** Click **Add Realm**.

**Step 3** Name the authentication realm.

All sequence and realm names must be unique and only contain alphanumeric characters or the space character. Also, if the Web Security appliance is managed by a Security Management appliance, ensure that same-named authentication realms on different Web Security appliances have identical properties defined on each appliance.

**Step 4** Select **NTLM** in the Authentication Protocol and Scheme(s) field.

**Step 5** Enter up to three fully-qualified domain names or IP addresses for the Active Directory server(s).

Example: `ntlm.example.com`.

An IP address is required only if the DNS servers configured on the appliance cannot resolve the Active Directory server hostname.

When multiple authentication servers are configured in the realm, the appliance attempts to authorize with up to three authentication servers before failing to authorize the transaction within this realm.

**Step 6** Join the appliance to the domain:

- Configure the Active Directory Account:

Setting	Description
Active Directory Domain	The Active Directory server domain name. Also known as a DNS Domain or realm.

Setting	Description
NetBIOS domain name	If the network uses NetBIOS, provide the domain name.
Computer Account	Specify a location within the Active Directory domain where AsyncOS will create an Active Directory computer account, also known as a “machine trust account”, to uniquely identify the computer on the domain.  If the Active Directory environment automatically deletes computer objects at particular intervals, specify a location for the computer account that is in a container, protected from automatic deletion.

b. Click **Join Domain**.

c. Enter the sAMAccountName user name and password for an existing Active Directory user.

Example: “jazzdoe” Do not use: “DOMAIN\jazzdoe” or “jazzdoe@domain”

This information is used once to establish the computer account and is not saved.

Verify that users enter their sAMAccountName user name when they log in to their computers.

d. Click **Create Account**.

**Step 7** (Optional) Configure transparent user identification.

Setting	Description
<b>Enable Transparent User Identification using Active Directory agent</b>	Enter both the server name for the machine where the primary Active Directory agent is installed and the shared secret used to access it.  (Optional) Enter the server name for the machine where a backup Active Directory agent is installed and its shared secret.

**Step 8** Configure Network Security:

Setting	Description
Client Signing Required	Select this option if the Active Directory server is configured to require client signing.  With this option selected, AsyncOS uses Transport Layer Security when communicating with the Active Directory server.

**Step 9** Click **Start Test**.

**Step 10** Submit and commit your changes.

#### Related topics

- [Identifying Users Transparently, page 8-12.](#)
- [Authentication Realm Testing, page 20-17](#)

## Deleting Authentication Realms

When you delete a realm, the Web Security appliance automatically deletes that realm from any sequence that used it. Also, any Identity policy group that depends on the deleted realm becomes disabled.

- 
- Step 1** On the Network > Authentication page, click the trash can icon for the realm name.
- Step 2** Confirm that you want to delete the realm by clicking **Delete**.
- Step 3** Commit your changes.
- 

## Working with Authentication Sequences

When you create more than one realm, you can group the realms into an authentication sequence. An authentication sequence is a group of authentication realms listed in the order the Web Security appliance uses for authenticating clients.

You can perform any of the following tasks when configuring authentication sequences:

- Create multiple authentication sequences.
- Include one or more realms in an authentication sequence.
- Include realms of different protocols in a single authentication sequence.
- Assign a realm or a sequence to an Identity group.

You create authentication sequences on the Network > Authentication page under the Realm Sequences section. The Realm Sequences section only appears when you create two or more realms.

After you create the second realm, the appliance automatically displays the Realm Sequences section and includes a default authentication sequence named All Realms. The All Realms sequence automatically includes each realm you define. You can change the order of the realms within the All Realms sequence, but you cannot delete any of its realms. You cannot delete the All Realms sequence.

**Note**

When multiple NTLM authentication realms are defined, AsyncOS only uses NTLMSSP with one NTLM authentication realm in any sequence. You can choose which NTLM authentication realm to use for NTLMSSP for all sequences, including the All Realms sequence. To use NTLMSSP with multiple NTLM realms, define a separate Identity for each realm.

---

## Creating Authentication Sequences

You can create an authentication sequence when multiple authentication realms are defined.

- 
- Step 1** On the Network > Authentication page, click **Add Sequence**.
- Step 2** Enter a name for the sequence in the Name for Realm Sequence field.



---

**Note** All sequence and realm names must be unique and only contain alphanumeric characters or the space character. Also, if the Web Security appliance is managed by a Security Management appliance, ensure that authentication realms on different Web Security appliances with the same name have the exact same properties defined on each appliance.

---

- Step 3** In the first row of the Realm Sequence for Basic Scheme area, choose the first authentication realm you want to include in the sequence.
- Step 4** In the second row of the Realm Sequence for Basic Scheme area, choose the next realm you want to include in the sequence.
- Step 5** (Optional) Click **Add Row** to include another realm that uses Basic credentials.



---

**Note** You can delete a realm from the sequence by clicking the trash can icon for that row.

---

- Step 6** If an NTLM realm is defined, choose an NTLM realm in the Realm for NTLMSSP Scheme field. The Web Proxy uses this NTLM realm when the client sends NTLMSSP authentication credentials.
- Step 7** Submit and commit your changes.
- 

## Deleting Authentication Sequences

If you delete an authentication sequence, any Access Policy group that depends on the deleted sequence becomes disabled.

---

- Step 1** On the Network > Authentication page, click the trash can icon for the sequence name.
- Step 2** Confirm that you want to delete the sequence by clicking **Delete**.
- Step 3** Commit your changes.
- 

## Appliance Behavior with Multiple Authentication Realms

You can configure the Web Security appliance to attempt authenticating clients against multiple authentication servers, and against authentication servers with different authentication protocols. When you configure the appliance to authenticate against multiple authentication servers, it only requests the credentials from the clients once. This is true even when you configure the appliance to authenticate against different protocols.

You might want to configure an Identity group to authenticate against different realms if your organization acquires another organization that has its own authentication server using the same or a different authentication protocol. That way, you can create one Identity group for all users and assign to the Identity group an authentication sequence that contains a realm for each authentication server.

When you assign an authentication sequence with multiple realms to an Identity group and a client sends a web request, the appliance performs the following actions:

1. The appliance gets the credentials from the client.



2. If the client provides NTLMSSP credentials, and if the sequence has an NTLM realm selected in the “Realm for NTLMSSP Scheme” field, the appliance attempts to authenticate the client against the authentication server(s) defined in the specified NTLM realm.
3. If the client provides Basic credentials, the appliance attempts to authenticate the client against the authentication server(s) defined in the first realm in the “Realm Sequence for Basic Scheme” section.
4. If the Basic client credentials do not match a user in the servers defined in the first Basic realm, it tries to authenticate against the authentication server(s) in the next Basic realm in the sequence.
5. The appliance continues trying to authenticate the client against servers in the next Basic realms until it either succeeds or runs out of authentication realms.
6. When authentication succeeds, the appliance assigns an Access Policy, and passes the server response to the client.
7. When the appliance fails to authenticate the client against any authentication realm in the sequence, the appliance does not allow the client to connect to the destination server. Instead, it displays an error message to the client.

**Tip**

---

For optimal performance, configure clients on a subnet to be authenticated in a single realm.

---

## Authentication Realm Testing

When you test authentication settings, the Web Security appliance first verifies that the settings you entered for the realm are in valid formats. For example, if a field requires a string and it currently contains a numeric value, the appliance informs you of that error.

If all fields contain valid values, the appliance performs different steps, depending on the authentication protocol. If the realm contains multiple authentication servers, the appliance goes through the testing process for each server in turn.

The appliance continues testing all servers in the realm and determines as many failures as possible for each server. It reports the testing outcome of each server in the realm.

### LDAP Testing

The appliance performs the following steps when you test LDAP authentication settings:

1. It ensures that the LDAP server is listening on the specified LDAP port.
  2. If Secure LDAP is selected, the appliance ensures the LDAP server supports secure LDAP.
  3. It performs an LDAP query using the supplied Base DN, User Name Attribute, and User Filter Query.
  4. If the realm includes Bind Parameters, the appliance validates them by forming an LDAP query with the Bind Parameters.
  5. If Group Authorization is provided, the appliance ensures that the specified group attributes are valid by fetching the groups from the server.
-

## NTLM Testing

The appliance performs the following steps when you test NTLM authentication settings:

1. It ensures that the specified Active Directory server is reachable and responds to queries.
2. It ensures that a DNS lookup on the Active Directory domain is successful since the Active Directory domain must be a DNS domain name and not a WINS domain name.
3. It ensures the system time of the appliance and the system time of the Active Directory server are within three minutes of each other.
4. It validates the user credentials by generating a kerberos ticket.
5. It validates whether the user has the proper privileges to add the Web Security appliance to the Active Directory domain.
6. It validates whether you can fetch the groups within the domain.

## Configuring Global Authentication Settings

Some authentication settings are independent of any realm you define. For example, you can configure whether or not clients send authentication credentials to the Web Security appliance securely, even when using Basic authentication scheme. For more information, see [Sending Authentication Credentials Securely, page 20-23](#).



### Note

The global authentication settings you can configure changes according to the Web Proxy deployment. You can configure more settings when it is deployed in transparent mode than in explicit forward mode.

**Step 1** On the Network > Authentication page, click **Edit Global Settings**.

**Step 2** Edit the settings in the Global Authentication Settings section as defined in [Table 20-8](#).

**Table 20-8 Global Authentication Settings**

Setting	Description
Action if Authentication Service Unavailable	Choose one of the following values: <ul style="list-style-type: none"> <li>• <b>Permit traffic to proceed without authentication.</b> Processing continues as if the user was authenticated.</li> <li>• <b>Block all traffic if user authentication fails.</b> Processing is discontinued and all traffic is blocked.</li> </ul>
Failed Authentication Handling	When you grant users guest access in an Identity policy, this setting determines how the Web Proxy identifies and logs the user as a guest in the access logs.  For more information on granting users guest access, see <a href="#">Allowing Guest Access to Users Who Fail Authentication, page 8-10</a> .

**Table 20-8 Global Authentication Settings (continued)**

Setting	Description
Re-authentication (Enable Re-Authentication Prompt If End User Blocked by URL Category or User Session Restriction)	<p>This setting allows users to authenticate again if the user is blocked from a website due to a restrictive URL filtering policy or due to being restricted from logging into another IP address.</p> <p>The user sees a block page that includes a link that allows them to enter new authentication credentials. If the user enters credentials that allow greater access, the requested page appears in the browser.</p> <p><b>Note:</b> This setting only applies to authenticated users who are blocked due to restrictive URL filtering policies or User Session Restrictions. It does not apply to blocked transactions by subnet with no authentication.</p> <p>For more information, see <a href="#">Allowing Users to Re-Authenticate, page 20-25</a>.</p>
Basic Authentication Token TTL	<p>Controls the length of time that user credentials are stored in the cache before revalidating them with the authentication server. This includes the username and password and the directory groups associated with the user.</p> <p>The default value is the recommended setting. When the Surrogate Timeout setting is configured and is greater than the Basic Authentication Token TTL, then the Surrogate Timeout value takes precedence and the Web Proxy contacts the authentication server after surrogate timeout expires.</p>

The remaining authentication settings you can configure depends on how the Web Proxy is deployed, in transparent or explicit forward mode.

**Step 3** If the Web Proxy is deployed in transparent mode, edit the settings in [Table 20-9](#).

**Table 20-9 Transparent Proxy Mode Authentication Settings**

Setting	Description
Credential Encryption	<p>This setting specifies whether or not the client sends the login credentials to the Web Proxy through an encrypted HTTPS connection.</p> <p>This setting applies to both Basic and NTLMSSP authentication schemes, but it is particularly useful for Basic authentication scheme because user credentials are sent as plain text.</p> <p>For more information, see <a href="#">Sending Authentication Credentials Securely, page 20-23</a>.</p>
HTTPS Redirect Port	<p>Specify a TCP port to use for redirecting requests for authenticating users over an HTTPS connection.</p> <p>This specifies through which port the client will open a connection to the Web Proxy using HTTPS. This occurs when credential encryption is enabled or when using SaaS Access Control and SaaS users are prompted to authenticate.</p>

Table 20-9 Transparent Proxy Mode Authentication Settings (continued)

Setting	Description
Redirect Hostname	<p>Enter the short hostname of the network interface on which the Web Proxy listens for incoming connections.</p> <p>When you configure authentication on an appliance deployed in transparent mode, the Web Proxy uses this hostname in the redirection URL sent to clients for authenticating users.</p> <p>You can enter either the following values:</p> <ul style="list-style-type: none"> <li> <b>Single word hostname.</b> You can enter the single word hostname that is DNS resolvable by the client and the Web Security appliance. This allows clients to achieve true single sign-on with Internet Explorer without additional browser side setup.           <p>Be sure to enter the single word hostname that is DNS resolvable by the client and the Web Security appliance.</p> <p>For example, if your clients are in domain <code>mycompany.com</code> and the interface on which the Web Proxy is listening has a full hostname of <code>proxy.mycompany.com</code>, then you should enter <code>proxy</code> in this field. Clients perform a lookup on <code>proxy</code> and they should be able to resolve <code>proxy.mycompany.com</code>.</p> </li> <li> <b>Fully qualified domain name (FQDN).</b> You can also enter the FQDN or IP address in this field. However, if you do that and want true single sign-on for Internet Explorer and Firefox browsers, you must ensure that the FQDN or IP address is added to the client's Trusted Sites list in the client browsers.           <p>The default value is the FQDN of the M1 or P1 interface, depending on which interface is used for proxy traffic.</p> </li> </ul>
Credential Cache Options: Surrogate Timeout	<p>This setting specifies how long the Web Proxy waits before asking the client for authentication credentials again. Until the Web Proxy asks for credentials again, it uses the value stored in the surrogate (IP address or cookie).</p> <p>It is common for user agents, such as browsers, to cache the authentication credentials so the user will not be prompted to enter credentials each time.</p>
Credential Cache Options: Client IP Idle Timeout	<p>When IP address is used as the authentication surrogate, this setting specifies how long the Web Proxy waits before asking the client for authentication credentials again when the client has been idle.</p> <p>When this value is greater than the Surrogate Timeout value, this setting has no effect and clients are prompted for authentication after the Surrogate Timeout is reached.</p> <p>You might want to use this setting to reduce the vulnerability of users who leave their computers.</p>
Credential Cache Options: Cache Size	<p>Specifies the number of entries that are stored in the authentication cache. Set this value to safely accommodate the number of users that are actually using this device. The default value is the recommended setting.</p>

**Table 20-9** *Transparent Proxy Mode Authentication Settings (continued)*

Setting	Description
User Session Restrictions	<p>This setting specifies whether or not authenticated users are allowed to access the Internet from multiple IP addresses simultaneously.</p> <p>You might want to restrict access to one machine to prevent users from sharing their authentication credentials with non-authorized users. When a user is prevented from logging in at a different machine, an end-user notification page appears. You can choose whether or not users can click a button to login as a different username using the Re-authentication setting on this page.</p> <p>When you enable this setting, enter the restriction timeout value, which determines how long users must wait before being able to log into a machine with a different IP address. The restriction timeout value must be greater than the surrogate timeout value.</p> <p>You can remove a specific user or all users from the authentication cache using the <code>authcache</code> CLI command.</p>
Advanced	<p>When using Credential Encryption or SaaS Access Control, you can choose whether the appliance uses the digital certificate and key shipped with the appliance (the Cisco IronPort Web Security Appliance Demo Certificate) or a digital certificate and key you upload here.</p> <p>To upload a digital certificate and key, click <b>Browse</b> and navigate to the necessary file on your local machine. Then click <b>Upload Files</b> after you select the files you want.</p> <p>For more information, see <a href="#">Uploading Certificates and Keys to Use with Credential Encryption and SaaS Access Control</a>, page 20-24.</p>

**Step 4** If the Web Proxy is deployed in explicit forward mode, edit the settings in [Table 20-10](#).

**Table 20-10** *Explicit Forward Proxy Mode Authentication Settings*

Setting	Description
Credential Encryption	<p>This setting specifies whether or not the client sends the login credentials to the Web Proxy through an encrypted HTTPS connection. To enable credential encryption, choose “HTTPS Redirect (Secure)”. When you enable credential encryption, additional fields appear to configure how to redirect clients to the Web Proxy for authentication.</p> <p>This setting applies to both Basic and NTLMSSP authentication schemes, but it is particularly useful for Basic authentication scheme because user credentials are sent as plain text.</p> <p>For more information, see <a href="#">Sending Authentication Credentials Securely</a>, page 20-23.</p>
HTTPS Redirect Port	<p>Specify a TCP port to use for redirecting requests for authenticating users over an HTTPS connection.</p> <p>This specifies through which port the client will open a connection to the Web Proxy using HTTPS. This occurs when credential encryption is enabled or when using SaaS Access Control and SaaS users are prompted to authenticate.</p>

**Table 20-10** *Explicit Forward Proxy Mode Authentication Settings (continued)*

Setting	Description
Redirect Hostname	<p>Enter the short hostname of the network interface on which the Web Proxy listens for incoming connections.</p> <p>When you enable Authentication Mode above, the Web Proxy uses this hostname in the redirection URL sent to clients for authenticating users.</p> <p>You can enter either the following values:</p> <ul style="list-style-type: none"> <li> <b>Single word hostname.</b> You can enter the single word hostname that is DNS resolvable by the client and the Web Security appliance. This allows clients to achieve true single sign-on with Internet Explorer without additional browser side setup. Be sure to enter the single word hostname that is DNS resolvable by the client and the Web Security appliance. For example, if your clients are in domain <code>mycompany.com</code> and the interface on which the Web Proxy is listening has a full hostname of <code>proxy.mycompany.com</code>, then you should enter <code>proxy</code> in this field. Clients perform a lookup on <code>proxy</code> and they should be able to resolve <code>proxy.mycompany.com</code>. </li> <li> <b>Fully qualified domain name (FQDN).</b> You can also enter the FQDN or IP address in this field. However, if you do that and want true single sign-on for Internet Explorer and Firefox browsers, you must ensure that the FQDN or IP address is added to the client's Trusted Sites list in the client browsers. The default value is the FQDN of the M1 or P1 interface, depending on which interface is used for proxy traffic. </li> </ul>
Credential Cache Options: Surrogate Timeout	<p>This setting specifies how long the Web Proxy waits before asking the client for authentication credentials again. Until the Web Proxy asks for credentials again, it uses the value stored in the surrogate (IP address or cookie).</p> <p>Note that it is common for user agents, such as browsers, to cache the authentication credentials so the user will not be prompted to enter credentials each time.</p>
Credential Cache Options: Client IP Idle Timeout	<p>When IP address is used as the authentication surrogate, this setting specifies how long the Web Proxy waits before asking the client for authentication credentials again when the client has been idle.</p> <p>When this value is greater than the Surrogate Timeout value, this setting has no effect and clients are prompted for authentication after the Surrogate Timeout is reached.</p> <p>You might want to use this setting to reduce the vulnerability of users who leave their computers.</p>
Credential Cache Options: Cache Size	<p>Specifies the number of entries that are stored in the authentication cache. Set this value to safely accommodate the number of users that are actually using this device. The default value is the recommended setting.</p>

**Table 20-10** *Explicit Forward Proxy Mode Authentication Settings (continued)*

Setting	Description
User Session Restrictions	<p>This setting specifies whether or not authenticated users are allowed to access the Internet from multiple IP addresses simultaneously.</p> <p>You might want to restrict access to one machine to prevent users from sharing their authentication credentials with non-authorized users. When a user is prevented from logging at a different machine, an end-user notification page appears. You can choose whether or not users can click a button to login as a different username using the Re-authentication setting on this page.</p> <p>When you enable this setting, enter the restriction timeout value, which determines how long users must wait before being able to log into a machine with a different IP address. The restriction timeout value must be greater than the surrogate timeout value.</p> <p>You can remove a specific user or all users from the authentication cache using the <code>authcache</code> CLI command.</p>
Advanced	<p>When using Credential Encryption or SaaS Access Control, you can choose whether the appliance uses the digital certificate and key shipped with the appliance (the Cisco IronPort Web Security Appliance Demo Certificate) or a digital certificate and key you upload here.</p> <p>To upload a digital certificate and key, click <b>Browse</b> and navigate to the necessary file on your local machine. Then click <b>Upload Files</b> after you select the files you want.</p> <p>For more information, see <a href="#">Uploading Certificates and Keys to Use with Credential Encryption and SaaS Access Control</a>, page 20-24.</p>

**Step 5** Submit and commit your changes.

## Sending Authentication Credentials Securely

When authentication is used to identify clients using the Web, the client applications send the authentication credentials to the Web Proxy, which in turn passes them to the authentication server. How the credentials are passed from the clients to the Web Proxy depends on the authentication scheme used:

- **NTLMSSP.** The credentials are always passed to the Web Proxy securely. They are encrypted using a key specified by the Active Directory server and sent over HTTP.
- **Basic.** By default, the credentials are passed to the Web Proxy insecurely. They are encoded, but not encrypted, and sent over HTTP. However, you can configure the Web Security appliance so clients send authentication credentials securely. This works for both LDAP and NTLM Basic authentication.

When you configure the appliance to use credential encryption for Basic authentication, the Web Proxy redirects the client back to the Web Proxy, but this time using an encrypted connection using HTTPS. The client application makes either a GET or a CONNECT request depending on how the requests are forwarded to the appliance (explicitly or transparently) and how the client application is configured to forward HTTPS requests, either using the Web Proxy or not.

Then, using the secure HTTPS connection, the clients send the authentication credentials. The appliance uses its own certificate and private key to create an HTTPS connection with the client by default. Most browsers will warn users that the certificate is not valid. To prevent users from seeing the invalid certificate message, you can upload a certificate and key pair your organization uses. When you upload a certificate and key, the private key must be *unencrypted*. For information about uploading a certificate and key, see [Uploading Certificates and Keys to Use with Credential Encryption and SaaS Access Control](#), page 20-24.

To configure the appliance to use credential encryption, enable the Credential Encryption setting in the global authentication settings. For more information, see [Configuring Global Authentication Settings](#), page 20-18. You can also use the `advancedproxyconfig > authentication` CLI command. For more information, see [Advanced Proxy Configuration](#), page 5-20.

## Uploading Certificates and Keys to Use with Credential Encryption and SaaS Access Control

When credential encryption is enabled or when using SaaS Access Control, the appliance uses a digital certificate to securely establish a connection with the client application. By default, the Web Security appliance uses the “Cisco IronPort Web Security Appliance Demo Certificate” that comes installed. However, client applications are not programmed to recognize this certificate, so you can upload a digital certificate to the appliance that your applications recognize automatically.

Use the Advanced section on the Network > Authentication page to upload the certificate and key.

For more information on obtaining a certificate and private key pair to upload, see [Obtaining Certificates](#), page 26-31.



### Note

Any certificate and key you upload on the Network > Authentication page is only used for establishing secure connections with clients for credential encryption and authenticating SaaS users using SaaS Access Control. The certificate and key are not used for establishing secure HTTPS sessions when connecting to the Web Security appliance web interface. For more information on uploading a certificate and key pair for HTTPS connections to the web interface, see [Installing a Server Digital Certificate](#), page 26-30.

For more information on SaaS Access Control, see [Authenticating SaaS Users](#), page 15-2.

## Accessing HTTPS and FTP Sites with Credential Encryption Enabled

Credential encryption works because the Web Proxy redirects clients to the Web Proxy itself for authentication using an HTTPS connection. After successful authentication, the Web Proxy redirects clients back to the original website. In order to continue to identify the user, the Web Proxy must use a surrogate (either the IP address or a cookie).

However, using a cookie to track users when the client accesses HTTPS sites or FTP servers using FTP over HTTP does not work.

- **HTTPS.** The Web Proxy must resolve the user identity before assigning a Decryption Policy (and therefore, decrypt the transaction), but it cannot obtain the cookie to identify the user unless it decrypts the transaction.



- **FTP over HTTP.** The dilemma with accessing FTP servers using FTP over HTTP is similar to accessing HTTPS sites. The Web Proxy must resolve the user identity before assigning an Access Policy, but it cannot set the cookie from the FTP transaction.

Because of this, you should configure the appliance to use IP addresses as the surrogate when credential encryption is enabled.

**Note**

---

Authentication does not work with HTTPS and FTP over HTTP requests when credential encryption is enabled and configured to use cookies as the surrogate type. Therefore, with this configuration setup, HTTPS and FTP over HTTP requests only match Access Policies that do not require authentication. Typically, they often match the global Access Policy since it never requires authentication.

---

## Allowing Users to Re-Authenticate

AsyncOS for Web can block users from accessing different categories of websites depending on who is trying to access a website. In these cases, users successfully authenticate, but they are not authorized to access certain websites due to configured URL filtering in the applicable Access Policy. You can allow these authenticated users another opportunity to access the web if they fail authorization.

**Note**

---

Only authenticated users are allowed to re-authenticate, not unauthenticated users.

---

You might want to do this for shared workstations that have multiple users, but the default account has limited access. If the default account on the workstation is blocked from a website due to restrictive URL filtering, the user can enter different authentication credentials that allow broader, more privileged access.

To do this, enable the “Enable Re-Authentication Prompt If End User Blocked by URL Category or User Session Restriction” global authentication setting. The user sees a block page that includes a link that allows them to enter new authentication credentials. The Web Proxy evaluates those credentials against the authentication realms defined in the applicable Identity group, and if the new credentials allow greater access, the requested page appears in the browser. For more information, see [Configuring Global Authentication Settings, page 20-18](#).

**Note**

---

The Web Proxy evaluates the new credentials against the authentication realms defined in the applicable Identity group only. It does not compare them against all other Identity groups.

---

When a more privileged user authenticates and gets access, the Web Proxy caches the privileged user identity for different amounts of time depending on the authentication surrogates configured:

- **Session cookie.** The privileged user identity is used until the browser is closed or the session times out.
- **Persistent cookie.** The privileged user identity is used until the surrogate times out.
- **IP address.** The privileged user identity is used until the surrogate times out.
- **No surrogate.** By default, the Web Proxy requests authentication for every new connection, but when re-authentication is enabled, the Web Proxy requests authentication for every new *request*, so there is an increased load on the authentication server when using NTLMSSP. Most browsers will cache the privileged user credentials and authenticate without prompting the user until the browser

is closed. When the Web Proxy is deployed in transparent mode, and the “Apply same surrogate settings to explicit forward requests” option is *not* enabled, no authentication surrogates are used for explicit forward requests.

**Note**

To use the re-authentication feature with user defined end-user notification pages, the CGI script that parses the redirect URL must parse and use the Reauth\_URL parameter. For more information, see [Defining End-User Notification Pages Off-Box, page 16-9](#).

## Using Re-Authentication with Internet Explorer

When you enable re-authentication and clients use Microsoft Internet Explorer, you need to verify certain settings to ensure re-authentication works properly with Internet Explorer. Due to a known issue with Internet Explorer, re-authentication does not work properly under the following circumstances:

- Internet Explorer is configured to use the Web Security appliance as a proxy.
- The Web Security appliance uses NTLMSSP authentication.
- The Web Security appliance uses cookies for authentication surrogates, but is not configured for credential encryption.
- The Web Proxy is deployed in explicit forward mode, or it is deployed in transparent mode and the “Apply same surrogate settings to explicit forward requests” option is enabled in the applicable Identity group.

Problems occur when authentication is required to access the site, and may occur either when initially requesting the site or when re-authenticating to try to access the site.

To work around these problems, enable credential encryption on the Network > Authentication page.

## Using Re-Authentication with PAC Files

When you enable re-authentication and configure client applications to use a PAC file, you may need to verify certain settings to ensure re-authentication works properly with the PAC file.

Re-authentication does not work properly under the following circumstances:

- Client browsers are configured to use a PAC file, and the PAC file is designed to bypass the Web Proxy for internal web servers. Instead of instructing the browser to explicitly send requests to the Web Proxy, it instructs the browser to directly send the request to the destination server.
- The Web Security appliance uses IP addresses for authentication surrogates or no surrogates, and credential encryption is not enabled.
- The Web Proxy is deployed in explicit forward mode, or it is deployed in transparent mode and the “Apply same surrogate settings to explicit forward requests” option is enabled for the applicable Identity group.

Problems occur because re-authentication requires clients to be redirected to the Web Proxy for authentication, but the PAC file bypasses all requests to internal web servers, including the Web Security appliance.

To work around these problems, edit the PAC file so that the function FindProxyForURL() returns “PROXY x.x.x.x:80” when the host IP address is x.x.x.x. The port number you specify in the return should be the same port configured for other destinations.

**Note**

If the Web Security appliance uses cookies for authentication surrogates, Cisco recommends enabling credential encryption. For more information, see [Using Re-Authentication with Internet Explorer](#), page 20-26.

## Tracking Authenticated Users

[Table 20-11](#) describes which authentication surrogates are supported with other configurations for explicitly forwarded requests.

**Table 20-11 Supported Authentication Surrogates for Explicit Requests**

Surrogate Types	Credential Encryption Disabled			Credential Encryption Enabled		
	HTTP	HTTPS & FTP over HTTP	Native FTP	HTTP	HTTPS & FTP over HTTP	Native FTP
No Surrogate	Yes	Yes	Yes	NA	NA	NA
IP-based	Yes	Yes	Yes	Yes	Yes	Yes
Cookie-based	Yes	Yes***	Yes***	Yes	No/Yes**	Yes***

[Table 20-12](#) describes which authentication surrogates are supported with other configurations for transparent requests.

**Table 20-12 Supported Authentication Surrogates for Transparent Requests**

Surrogate Types	Credential Encryption Disabled			Credential Encryption Enabled		
	HTTP	HTTPS	Native FTP	HTTP	HTTPS	Native FTP
No Surrogate	NA	NA	NA	NA	NA	NA
IP-based	Yes	No/Yes*	No/Yes*	Yes	No/Yes*	No/Yes*
Cookie-based	Yes	No/Yes**	No/Yes**	Yes	No/Yes**	No/Yes**

\* Works after the client makes a request to an HTTP site and is authenticated. Before this happens, the behavior depends on the transaction type:

- **Native FTP transactions.** Transactions bypass authentication.
- **HTTPS transactions.** Transactions are dropped. However, you can configure the HTTPS Proxy to decrypt the first HTTPS request for authentication purposes.

\*\* When cookie-based authentication is used, the Web Proxy cannot authenticate the user for HTTPS, native FTP, and FTP over HTTP transactions. Due to this limitation, all HTTPS, native FTP, and FTP over HTTP requests bypass authentication, so authentication is not requested at all. For more information on how HTTPS requests are assigned Identity and non-Identity policy groups, see [Understanding How Authentication Affects HTTPS and FTP over HTTP Requests](#), page 8-6.

\*\*\* No surrogate is used in this case even though cookie-based surrogate is configured.

# Bypassing Authentication

Some client applications, such as some instant messaging applications or applets, and servers do not handle authentication well. For example, some clients do not handle NTLMSSP at all, while others might not strictly follow the authentication standard. When the Web Proxy processes transactions between these applications or servers, authentication might fail.

You can work around these limitations by bypassing authentication for the affected clients and servers.

- 
- Step 1** Create a custom URL category that contains the affected websites by configuring the Advanced properties.
  - Step 2** Create an Identity group that only applies to the affected client applications and the custom URL category created in [Step 1](#).
  - Step 3** Place the Identity before all other Identities that require authentication.
  - Step 4** Configure the Identity so it does not require authentication.
  - Step 5** Use the Identity in other policy groups as needed.
- 

# LDAP Authentication

The Lightweight Directory Access Protocol (LDAP) server database is a repository for employee directories. These directories include the names of employees along with various types of personal data such as a phone number, email address, and other information that is exclusive to the individual employee. The LDAP database is composed of objects containing attributes and values. Each object name is referred to as a distinguished name (DN). The location on the LDAP server where a search begins is called the Base Distinguished Name or base DN.

The appliance supports standard LDAP server authentication and Secure LDAP authentication. Support for LDAP allows established installations to continue using their LDAP server database to authenticate users.

For Secure LDAP, the appliance supports LDAP connections over SSL. The SSL protocol is an industry standard for ensuring confidentiality. SSL uses key encryption algorithms along with Certificate Authority (CA) signed certificates to provide the LDAP servers a way to verify the identity of the appliance.

**Note**

---

AsyncOS for Web only supports 7-bit ASCII characters for passwords when using the Basic authentication scheme. Basic authentication fails when the password contains characters that are not 7-bit ASCII.

---

# Changing Active Directory Passwords

After Active Directory LDAP users change their account passwords, the Active Directory LDAP server authenticates them with their current or previous password, depending on the Active Directory server configuration.

If you want users to only be able to authenticate with their new password, you can reboot the Active Directory server or, you can wait for the Active Directory server to time out the old passwords.

## LDAP Group Authorization

You can use the user group membership information stored in an LDAP directory to apply a policy group to a group of users. To do this, enable group authorization in an LDAP authentication realm and group users by one of the following LDAP object types:

- **Group object.** Sometimes, group membership information is stored in the group object, which has an attribute (such as “member”) to list all users that belong to the group. Define authorized users by group object when the group object contains all users you need to define. For more information on how to define authorized users by group object, see [Table 20-13 on page 20-30](#).
- **User object.** Sometimes, group membership information is stored in the user object, which has an attribute (such as “memberOf”) that lists all groups to which a user belongs. You might want to define authorized users by user object when the authentication server does not store the member information in the group object or if it does not have a group object. For more information on how to define authorized users by user object, see [Table 20-14 on page 20-30](#).



---

**Note** The user object must not contain any special character.

---

When you configure group authorization in an LDAP authentication realm, be sure you uniquely identify a group object in the LDAP server. If the search for a group DN returns multiple entries, the Web Security appliance only uses the first entry returned. You uniquely identify a group object using the following fields:

- Base DN
- Attribute that contains the group name
- Query string to determine if object is a group

When you create an LDAP authentication realm with user object based group authorization against an Active Directory server, the user object does not contain the primary group that the user is a member of, for example “Domain Users.” It only contains the other defined groups. Therefore, policy groups might not match these users under the following conditions:

- An Identity policy group specifies an LDAP realm with user attribute based group authentication.
- A non-Identity policy group uses the Identity policy group and the primary group is configured as an authorized group in the Active Directory server.

Table 20-13 describes the group object settings.

**Table 20-13 LDAP Group Authorization—Group Object Settings**

Group Object Setting	Description
Group Membership Attribute Within Group Object	<p>Choose the LDAP attribute which lists all users that belong to this group.</p> <p>Choose one of the following values:</p> <ul style="list-style-type: none"> <li>• <b>member</b> and <b>uniquemember</b>. Unique identifiers in the LDAP directory that specify group members.</li> <li>• <b>custom</b>. A custom identifier such as <code>UserInGroup</code>.</li> </ul>
Attribute that Contains the Group Name	<p>Choose the LDAP attribute which specifies the group name that can be used in the policy group configuration.</p> <p>Choose one of the following values:</p> <ul style="list-style-type: none"> <li>• <b>cn</b>. A unique identifier in the LDAP directory that specifies the name of a group.</li> <li>• <b>custom</b>. A custom identifier such as <code>FinanceGroup</code>.</li> </ul>
Query String to Determine if Object is a Group	<p>Choose an LDAP search filter that determines if an LDAP object represents a user group.</p> <p>Choose one of the following values:</p> <ul style="list-style-type: none"> <li>• <b>objectclass=groupofnames</b></li> <li>• <b>objectclass=groupofuniquenames</b></li> <li>• <b>objectclass=group</b></li> <li>• <b>custom</b>. A custom filter such as <code>objectclass=person</code>.</li> </ul> <p><b>Note:</b> The query defines the set of authentication groups which can be used in policy groups.</p>

Table 20-14 describes the user object settings.

**Table 20-14 LDAP Group Authorization—User Object Settings**

User Object Setting	Description
Group Membership Attribute Within User Object	<p>Choose the attribute which list all the groups that this user belongs to.</p> <p>Choose one of the following values:</p> <ul style="list-style-type: none"> <li>• <b>memberOf</b>. Unique identifiers in the LDAP directory that specify user members.</li> <li>• <b>custom</b>. A custom identifier such as <code>UserInGroup</code>.</li> </ul>
Group Membership Attribute is a DN	<p>Specify whether the group membership attribute is a distinguished name (DN) which refers to an LDAP object. For Active Directory servers, enable this option.</p> <p>When this is enabled, you must configure the subsequent settings.</p>

Table 20-14 LDAP Group Authorization—User Object Settings (continued)

User Object Setting	Description
Attribute that Contains the Group Name	<p>When the group membership attribute is a DN, this specifies the attribute that can be used as group name in policy group configurations.</p> <p>Choose one of the following values:</p> <ul style="list-style-type: none"> <li>• <b>cn.</b> A unique identifier in the LDAP directory that specifies the name of a group.</li> <li>• <b>custom.</b> A custom identifier such as <code>FinanceGroup</code>.</li> </ul>
Query String to Determine if Object is a Group	<p>Choose an LDAP search filter that determines if an LDAP object represents a user group.</p> <p>Choose one of the following values:</p> <ul style="list-style-type: none"> <li>• <b>objectclass=groupofnames</b></li> <li>• <b>objectclass=groupofuniquenames</b></li> <li>• <b>objectclass=group</b></li> <li>• <b>custom.</b> A custom filter such as <code>objectclass=person</code>.</li> </ul> <p><b>Note:</b> The query defines the set of authentication groups which can be used in Web Security Manager policies.</p>

## NTLM Authentication

The NT Lan Manager (NTLM) authenticates users with an encrypted challenge-response sequence that occurs between the appliance and a Microsoft Windows domain controller. The NTLM challenge-response handshake occurs when a web browser attempts to connect to the appliance and before data is delivered.

When you configure an NTLM authentication realm, you do not specify the authentication scheme. Instead, you choose the scheme when you use the realm in an Identity group. This allows you to choose different schemes for different Identities. When you create or edit the Identity group, you can choose one of the following schemes:

- Use NTLMSSP
- Use Basic or NTLMSSP
- Use Basic



**Note**

AsyncOS for Web only supports 7-bit ASCII characters for passwords when using the Basic authentication scheme. Basic authentication fails when the password contains characters that are not 7-bit ASCII.

## Authenticating Users Against Multiple Active Directory Domains

An NTLM realm is configured to join one Active Directory domain. However, the Web Proxy can also authenticate users against domains in either the same or a different forest when the following conditions exist:

- When all Active Directory domains exist in the same forest, there must be a trust relationship among all domains in the forest.
- When an Active Directory domain exists in a different forest, the domain that the Web Security appliance joins must have at least a one way trust with the domain where the users belong.

AsyncOS allows you to create up to 10 NTLM authentication realms. You might want to create multiple NTLM realms when the Web Proxy must authenticate users in different Active Directory forests that do not have mutual trust with another forest.

**Note**

To create multiple NTLM realms, the client IP addresses in one NTLM realm must not overlap with the client IP addresses in another NTLM realm.

When you define policy group membership by group name, the web interface only displays Active Directory groups in the domain where AsyncOS created a computer account when joining the domain. To create a policy group for users in a different domain, manually enter the domain and group name in the web interface.

**Note**

Cisco recommends creating as few NTLM realms as necessary. Creating multiple NTLM realms requires additional memory usage for authentication.

## Supported Authentication Characters

This section lists the characters the Web Security appliance supports when it communicates with LDAP and Active Directory servers. For authentication to work properly, verify that your authentication servers only use the supported characters listed in this section.

For example, according to [Table 20-15](#), the appliance can validate users with the following Active Directory user name:

```
jsmith#123
```

And according to [Table 20-15](#), the appliance cannot validate users with the following Active Directory user name:

```
jsmith+
```

## Active Directory Server Supported Characters

[Table 20-15](#) lists the characters the Web Security appliance supports for the User Name field for Active Directory servers.

**Table 20-15** Supported Active Directory Server Characters — User Name Field

Supported Characters	Characters Not Supported
A...Z a...z 0 1 2 3 4 5 6 7 8 9 ` ~ ! # \$ % ^ & ( ) _ - { } ' . @ space	/ \ [ ] : ;   = , + * ? < > "



**Note**

The Web Security appliance supports the percent ( %) character for end users browsing the web. However, you cannot use a user name with the percent ( %) character to join the Active Directory domain when you create an NTLM authentication realm.

Table 20-16 lists the characters the Web Security appliance supports for the Password field for Active Directory servers.

**Table 20-16 Supported Active Directory Server Characters – Password Field**

Supported Characters	Characters Not Supported
A...Z a...z 0 1 2 3 4 5 6 7 8 9 ` ~ ! # \$ ^ & ( ) _ - { } ' . / [ ] :   * ? @ + \ , ; " = < > space	N/A

Table 20-17 lists the characters the Web Security appliance supports for the Location field for Active Directory servers. You enter the location string in the Location field when you configure an NTLM authentication realm.

**Table 20-17 Supported Active Directory Server Characters – Location Field**

Supported Characters	Characters Not Supported
A...Z a...z 0 1 2 3 4 5 6 7 8 9 ` ~ ! # \$ ^ & ( ) _ - { } ' . / [ ] :   * ? @ space	+ \ , ; " = < >  <b>Note</b> The appliance does not support these characters even when they are escaped with a backslash ( \ ) character.

Table 20-18 lists the characters the Web Security appliance supports for the Group field for Active Directory servers.

**Table 20-18 Supported Active Directory Server Characters – Group Field**

Supported Characters	Characters Not Supported
A...Z a...z 0 1 2 3 4 5 6 7 8 9 ` ~ ! # \$ % ^ & ( ) _ - { } ' . @ space	/ \ [ ] : ;   = , + * ? < > "

**Note**

You can only use the backslash ( \ ) character as a separator between the domain name and a user or group name, or as a separator between organizational units (OU) in the location string for an Active Directory server. You cannot use it as part of a domain name, user name, group name, or location name.

## LDAP Server Supported Characters

Table 20-19 lists the characters the Web Security appliance supports for the User Name field for LDAP servers.

**Table 20-19 Supported LDAP Server Characters — User Name Field**

Supported Characters	Characters Not Supported
A...Z a...z 0 1 2 3 4 5 6 7 8 9 ` ~ ! # \$ % ^ & ( ) _ - { } ' . @	/ \ [ ] : ;   = , + * ? < > "
<b>Note</b> The appliance only supports the '(' and ')' characters when they are escaped with a backslash (\) character.	

Table 20-20 lists the characters the Web Security appliance supports for the Password field for LDAP servers.

**Table 20-20 Supported LDAP Server Characters — Password Field**

Supported Characters	Characters Not Supported
A...Z a...z 0 1 2 3 4 5 6 7 8 9 ` ~ ! # \$ % ^ & ( ) _ - { } @ ' . / \ [ ] :   = * ? < > " , ; + space	N/A

Table 20-21 lists the characters the Web Security appliance supports for the Group field for LDAP servers.

**Table 20-21 Supported LDAP Server Characters — Group Field**

Supported Characters	Characters Not Supported
A...Z a...z 0 1 2 3 4 5 6 7 8 9 ` ~ ! # \$ % ^ & ( ) _ - { } @ ' . / \ [ ] :   = * ? < > " space	, ; +
<b>Note</b> The appliance only supports the '(' and ')' characters when they are escaped with a backslash (\) character.	

Table 20-22 lists the characters the Web Security appliance supports for the Custom User Filter Query Field field for LDAP servers.

**Table 20-22 Supported LDAP Server Characters — Custom User Filter Query Field**

Supported Characters	Characters Not Supported
A...Z a...z 0 1 2 3 4 5 6 7 8 9 ` ~ ! # \$ % ^ & ( ) _ - { } ' . space	@ / \ [ ] :   = * ? < > " , ; +

Table 20-23 lists the characters the Web Security appliance supports for the Custom Group Filter Query Field field for LDAP servers.

**Table 20-23 Supported LDAP Server Characters — Custom Group Filter Query Field**

Supported Characters	Characters Not Supported
A...Z a...z 0 1 2 3 4 5 6 7 8 9 ` ~ ! # \$ % ^ & ( ) _ - { } @ ' . / \ [ ] :   = * ? < > " space	, ; +













# 21

## L4 Traffic Monitor

---

- [About L4 Traffic Monitor, page 21-1](#)
- [Understanding How the L4 Traffic Monitor Works, page 21-1](#)
- [Configuring the L4 Traffic Monitor, page 21-2](#)
- [Viewing L4 Traffic Monitor Activity, page 21-5](#)

### About L4 Traffic Monitor

The Web Security appliance has an integrated Layer-4 Traffic Monitor that detects rogue traffic across all network ports and stops malware attempts to bypass port 80. Additionally, when internal clients are infected with malware and attempt to phone-home across non-standard ports and protocols, the L4 Traffic Monitor prevents phone-home activity from going outside the corporate network.

### Understanding How the L4 Traffic Monitor Works

The L4 Traffic Monitor listens to network traffic that comes in over all ports on the appliance and matches domain names, and IP addresses against entries in its own database tables to determine whether to allow incoming and outgoing traffic.

All web destinations fall under one of the following categories:

- **Known allowed address.** Any IP address or hostname listed in the Allow List property. These addresses appear in the log files as “whitelist” addresses.
- **Unlisted address.** Any IP address that is not known to be a malware site nor is a known allowed address. They are not listed on the Allow List or Additional Suspected Malware Addresses properties, nor are they listed in the L4 Traffic Monitor Database as a known malware site. These addresses do not appear in the log files.
- **Ambiguous address.** These addresses appear in the log files as “greylist” addresses. They include any of the following addresses:
  - Any *IP address* that is associated with both an unlisted *hostname* and a known malware *hostname*.
  - Any *IP address* that is associated with both an unlisted *hostname* and a *hostname* from the Additional Suspected Malware Addresses property.
- **Known malware address.** These addresses appear in the log files as “blacklist” addresses. They include any of the following addresses:
  - Any IP address or hostname that the L4 Traffic Monitor Database determines to be a known malware site and *not* listed in the Allow List.

- Any *IP address* that is listed in the Additional Suspected Malware Addresses property and *not* listed in the Allow List and *not* determined to be ambiguous.

**Note**

You can define the Allow List and the Additional Suspected Malware Addresses properties on the Web Security Manager > L4 Traffic Monitor Policies page.

The L4 Traffic Monitor listens to and monitors network ports for rogue activity. It performs one of the following actions on all traffic on your network:

- **Allow.** It always allows traffic to and from known allowed and unlisted addresses.
- **Monitor.** It monitors traffic under the following circumstances:
  - When the Action for Suspected Malware Addresses option is set to Monitor, it always monitors all traffic that is not to or from a known allowed address.
  - When the Action for Suspected Malware Addresses option is set to Block, it monitors traffic to and from ambiguous addresses.
- **Block.** When the Action for Suspected Malware Addresses option is set to Block, it blocks traffic to and from known malware addresses.

## The L4 Traffic Monitor Database

The L4 Traffic Monitor uses and maintains its own internal database. This database is continuously updated with matched results for IP addresses and domain names. Additionally, the database table receives periodic updates from the Cisco IronPort update server at the following location:

`https://update-manifests.ironport.com`

For information about update intervals and the Cisco IronPort update server, see [Manually Updating Security Service Components, page 26-41](#).

## Configuring the L4 Traffic Monitor

The L4 Traffic Monitor can be enabled as part of an initial system setup using the System Setup Wizard. By default, the L4 Traffic Monitor is enabled and set to monitor traffic on all ports. This includes DNS and other services.

**Note**

To monitor true client IP addresses, the L4 Traffic Monitor should always be configured inside the firewall and before network address translation (NAT). For more information about deploying the L4 Traffic Monitor, see [Deploying the L4 Traffic Monitor, page 3-11](#).

You can configure the following settings:

- **Global L4 Traffic Monitor settings.** You can enable or disable the L4 Traffic Monitor after an initial configuration and configure which TCP ports to monitor. Use the Security Services > L4 Traffic Monitor page. For more information see [Configuring L4 Traffic Monitor Global Settings, page 21-3](#).
- **L4 Traffic Monitor policies.** When the L4 Traffic Monitor is enabled, you configure specific policies for managing traffic. Use the Web Security Manager > L4 Traffic Monitor Policies page. For more information see [Configuring L4 Traffic Monitor Policies, page 21-3](#).

## Configuring L4 Traffic Monitor Global Settings

On the Security Services > L4 Traffic Monitor page, you can configure the L4 Traffic Monitor global settings and update the L4 Traffic Monitor anti-malware rules.

**Figure 21-1** Security Services > L4 Traffic Monitor Page

**L4 Traffic Monitor**

L4 Traffic Monitor Global Settings		
L4 Traffic Monitor Status:	Enabled	
Traffic Monitored On:	All Ports	
<a href="#">Edit Global Settings...</a>		

IronPort L4 Anti-Malware Rules Update		
Update Type	Last Update	Current Version
L4 Traffic Monitor Anti-Malware Rules	never updated	1.0
<a href="#">Update Now</a>		

- 
- Step 1** Navigate to the Security Services > L4 Traffic Monitor page.
- Step 2** Click **Edit Global Settings**.
- Step 3** Choose whether or not to enable the L4 Traffic Monitor.
- Step 4** When you enable the L4 Traffic Monitor, choose which ports it should monitor:
- **All ports.** Monitors all 65535 TCP ports for rogue activity.
  - **All ports except proxy ports.** Monitors all TCP ports except the following ports for rogue activity.
    - Ports configured in the “HTTP Ports to Proxy” property on the Security Services > Web Proxy page (usually port 80).
    - Ports configured in the “Transparent HTTPS Ports to Proxy” property on the Security Services > HTTPS Proxy page (usually port 443).
- Step 5** Submit and commit the changes.
- 

## Updating L4 Traffic Monitor Anti-Malware Rules

- 
- Step 1** Navigate to the Security Services > L4 Traffic Monitor page.
- Step 2** Click **Update Now**.
- The Web Security appliance contacts the component update server and updates the L4 Traffic Monitor anti-malware rules. For more information about the component update server, see [Manually Updating Security Service Components, page 26-41](#).
- 

## Configuring L4 Traffic Monitor Policies

When the L4 Traffic Monitor is enabled, you can configure how it should manage traffic over the configured TCP ports. It can perform the following actions on traffic over the TCP ports:

- Allow

- Monitor
- Block

For more information about how the L4 Traffic Monitor handles traffic, see [Understanding How the L4 Traffic Monitor Works, page 21-1](#).

The actions the L4 Traffic Monitor takes depends on the L4 Traffic Monitor policies you configure.

**Step 1** Navigate to the Web Security Manager > L4 Traffic Monitor page.

**Step 2** Click **Edit Settings**.

**Step 3** On the Edit L4 Traffic Monitor Policies page, configure the L4 Traffic Monitor policies described in [Table 21-1](#).

**Table 21-1 L4 Traffic Monitor Policies**

Property	Description
Allow List	<p>Enter zero or more address to which the L4 Traffic Monitor should always allow clients to connect.</p> <p>Separate multiple entries with a space or comma. For a list of valid address formats you can use, see <a href="#">Valid Formats, page 21-5</a>.</p> <p><b>Note</b> Entering a domain name such as example.com also matches www.example.com and hostname.example.com.</p> <p>Connections to all destinations in this list are always allowed and the traffic is not logged. The appliance does not check the destinations against the L4 Traffic Monitor anti-malware rules or the additional suspected malware addresses listed on the same page.</p> <p>For example, if IP address 10.1.1.1 appears in both the Allow List and the Additional Suspected Malware Addresses fields, then the L4 Traffic Monitor always allows requests for 10.1.1.1.</p> <p><b>Note</b> Do not include the Web Security appliance IP address or hostname to the Allow List otherwise the L4 Traffic Monitor does not block any traffic.</p>
Actions for Suspected Malware Addresses	<p>Choose whether to monitor or block traffic destined for a known malware address. For a definition of known malware address, see <a href="#">Understanding How the L4 Traffic Monitor Works, page 21-1</a>.</p> <ul style="list-style-type: none"> <li>• <b>Monitor.</b> Scans all traffic for domains and IP addresses that match entries in the L4 Traffic Monitor database. The Monitor option does not block suspicious traffic. This setting is useful for identifying infected clients without affecting the user experience.</li> <li>• <b>Block.</b> Scans all traffic for domains and IP addresses that match entries in the appliance administrative lists and the block list database and then blocks any traffic it finds. This setting is useful for identifying infected clients and stopping malware attempts through non-standard ports.</li> </ul> <p>When you choose to block suspected malware traffic, you can also choose whether or not to always block ambiguous addresses. By default, ambiguous addresses are monitored.</p> <p>For a definition of ambiguous address, see <a href="#">Understanding How the L4 Traffic Monitor Works, page 21-1</a>.</p>

**Table 21-1 L4 Traffic Monitor Policies (continued)**

Property	Description
Additional Suspected Malware Addresses (optional)	<p>Enter zero or more known addresses that the L4 Traffic Monitor should consider as a possible malware. For a list of valid address formats you can use, see <a href="#">Valid Formats, page 21-5</a>.</p> <p>If you choose to block suspected malware addresses, the L4 Traffic Monitor will either block or monitor these addresses depending on whether it determines them to be known malware addresses or ambiguous addresses. For definitions of ambiguous and known malware addresses, see <a href="#">Understanding How the L4 Traffic Monitor Works, page 21-1</a>.</p> <p>If you choose to monitor suspected malware addresses, it will monitor these addresses.</p> <p><b>Note</b> Adding internal IP addresses to the Additional Suspected Malware Addresses list causes legitimate destination URLs to show up as malware in L4 Traffic Monitor reports. To avoid this type of erroneous reporting, do not enter internal IP addresses in the “Additional Suspected Malware Addresses” field on the Web Security Manager &gt; L4 Traffic Monitor Policies page.</p>



**Note** If the L4 Traffic Monitor is configured to block, the L4 Traffic Monitor and the Web Proxy must be configured on the same network. Use the Network > Routes page to confirm that all clients are accessible on routes that are configured for data traffic.

**Step 4** Submit and commit your changes.

## Valid Formats

When you add addresses to the Allow List or Additional Suspected Malware Addresses properties, separate multiple entries with whitespace or commas. You can enter addresses in any of the following formats:

- **IP address.** For example, 10.1.1.0.
- **CIDR address.** For example, 10.1.1.0/24.
- **Domain name.** For example, example.com. Entering a domain name such as example.com will also match www.example.com and hostname.example.com.
- **Hostname.** For example, crm.example.com.

## Viewing L4 Traffic Monitor Activity

The S-Series appliance supports several options for generating feature specific reports and interactive displays of summary statistics.

## Monitoring Activity and Viewing Summary Statistics

The Reporting > L4 Traffic Monitor page provides statistical summaries of monitoring activity. You can interactively update these displays by specifying a time range of hour, day, week or month. Additionally, you have the option to print these display pages and export the raw data to a file.

You can use the following displays and reporting tools to view the results of L4 Traffic Monitor activity:

**Table 21-2** L4 Traffic Monitor Scanning Data

To view...	See...
Client statistics	Reporting > Client Activity
Malware statistics	Reporting > L4 Traffic Monitor
Port statistics	
L4 Traffic Monitor log files	System Administration > Log Subscriptions <ul style="list-style-type: none"> <li>• trafmon_errlogs</li> <li>• trafmonlogs</li> </ul>



### Note

If the Web Proxy is configured as a forward proxy and L4 Traffic Monitor is set to monitor all ports, the IP address of the proxy's data port is recorded and displayed as a client IP address in the client activity report on the Reporting > Client Activity page. If the Web Proxy is configured as a transparent proxy, enable IP spoofing to correctly record and display the client IP addresses.

## L4 Traffic Monitor Log File Entries

The L4 Traffic Monitor log file provides a detailed record of monitoring activity. For more information about the L4 Traffic Monitor log, see [Traffic Monitor Log, page 24-39](#).

# 22

## Reporting

---

- [Reporting Overview, page 22-1](#)
- [Using the Reporting Tab, page 22-2](#)
- [Enabling Centralized Reporting, page 22-8](#)
- [Scheduling Reports, page 22-8](#)
- [Generating Reports On Demand, page 22-9](#)
- [Archived Reports, page 22-10](#)
- [SNMP Monitoring, page 22-10](#)

## Reporting Overview

Reporting functionality aggregates information from individual security features and records data that can be used to monitor your web traffic patterns and security risks. You can run reports in real-time to view an interactive display of system activity over a specific period of time, or you can schedule reports and run them at regular intervals.

The Web Security appliance not only generates high-level reports, allowing you to understand what is happening on the network, but it also allows you to drill down and see traffic details for a particular domain, user, or category.

Reporting functionality also allows you to export raw data to a file. For more information see, [Printing and Exporting Reports from Report Pages, page 22-6](#).

## Working with Usernames in Reports

When you enable authentication, reports list users by their usernames when they authenticate with the Web Proxy. By default, usernames are written as they appear in the authentication server, such as jsmith. However, you can choose to make usernames unrecognizable in all reports.

**Note**

---

Administrators always see usernames in reports.

---

To make usernames unrecognizable in reports:

---

- Step 1** Navigate to the Security Services > Reporting page, and click **Edit Settings**.
- Step 2** Under Local Reporting, select **Anonymize usernames in reports**.
- Step 3** Submit and commit your changes.

## Report Pages

The Web Security appliance offers the following reports:

- Overview
- Users
- Web Sites
- URL Categories
- Application Visibility
- Anti-Malware
- Client Malware Risk
- Web Reputation Filters
- L4 Traffic Monitor
- Reports by User Location
- Web Tracking
- System Capacity
- System Status

For detailed descriptions of each of these reports, see [Web Security Appliance Reports, page 23-1](#).

## Using the Reporting Tab

The Reporting tab provides several options for viewing system data. This section describes those options and explains the information displayed on each report page.

The report pages provide a colorful overview of system activity and support multiple options for viewing system data. For example, you can update and sort data to provide real-time visibility into resource utilization and web traffic activity. You can also search each page for website and client-specific data.

You can perform the following tasks on most reports on the Reporting tab:

- **Change the time range displayed in a report.** For more information, see [Changing the Time Range, page 22-2](#).
- **Search for specific clients and domains.** For more information, see [Searching Data, page 22-3](#).
- **Choose which data to display in charts.** See [Choosing Which Data to Chart, page 22-4](#).
- **Choose and sort columns.** For more information, see [Working with Columns on Report Pages, page 22-4](#).
- **Export reports to external files.** For more information, see [Printing and Exporting Reports from Report Pages, page 22-6](#).

## Changing the Time Range

You can update the data displayed for each security component using the Time Range field. This option allows you to generate updates for predefined time ranges, such as the last hour or week, and it allows you to define custom time ranges from a specific start time to a specific end time.



**Note**

The time range you select is used throughout all of the report pages until you select a different value in the Time Range menu.

Figure 22-1 shows the Time Range field for the URL Categories report.

**Figure 22-1** Selecting Data Time Range



You can choose any of the time ranges described in Table 22-1.

**Table 22-1** Configurable Time Ranges

Time Range	Data is returned in...
Hour	Sixty (60) complete minutes plus up to 5 additional minutes.
Day	One hour intervals for the last 24 hours and including the current partial hour.
Week	One day intervals for the last 7 days plus the current partial day.
Month (30 days)	One day intervals for the last 30 days plus the current partial day.
Yesterday	The last 24 hours (00:00 to 23:59) using the Web Security appliance defined time zone.
Custom Range	The custom time range defined by the user.  When you choose Custom Range, a dialog box appears where you can enter the start and end times.

**Note**

All reports display date and time information based on the systems configured time zone, shown as a Greenwich Mean Time (GMT) offset. However, data exports display the time in GMT to accommodate multiple systems in multiple time zones around the world.

## Searching Data

Some reports include a field that allow you to search for a particular data points. For example, on the URL Categories report, you can search for a particular URL category, and on the Users report, you can search for a particular user by user name or IP address. When you search for data, the report refines the report data for the particular data set you are searching.

You can search for values that exactly match of the string you enter, or for values that start with the string you enter.

The following report pages include search fields:

- **Users.** Search for a user by user name or client IP address.
- **Web Sites.** Search for a server by domain or server IP address.
- **URL Categories.** Search for a URL category.
- **Application Visibility.** Search for an application name that the AVC engine monitors and blocks.
- **Client Malware Risk.** Search for a user by user name or client IP address.

**Note**

You need to configure authentication to view client user IDs as well as client IP addresses.

Figure 22-2 shows the search field for the URL Categories report.

**Figure 22-2 Searching for URL Categories**

The image shows a search interface with a text input field on the left and a button labeled 'Find URL Category' on the right.

## Choosing Which Data to Chart

The default charts on each Web Reporting page display commonly-referenced data, but you can choose to chart different data instead. If a page has multiple charts, you can change each chart.

Generally, the chart options are the same as the columns headings of the table(s) in the report. For explanations of these headings, see [Working with Columns on Report Pages, page 22-4](#).

Charts reflect all available data in a table column, regardless of the number of items (rows) you choose to display in the associated table.

To choose the data to chart:

- 
- Step 1** Click the **Chart Options** link below a chart.
  - Step 2** Choose the data to display.
  - Step 3** Click **Done**.
- 

## Working with Columns on Report Pages

Each page has interactive column headings that can be configured to sort the data in each column specific to your needs for viewing data on that page.

**Note**

Not every column is available for every report page. Click the Columns link for each report page to view the available columns.

Table 22-2 describes the columns available when working with reports.

**Table 22-2 Report Column Descriptions**

Column Name	Description
Domain or Realm	The domain or realm of the user displayed in text format.
User ID or Client IP	The username or client IP address of the user displayed in text format.
Bandwidth Used	The amount of bandwidth that is used by a particular user or action. Bandwidth units are displayed in Bytes or percentage.
Bandwidth Saved by Blocking	The amount of bandwidth that has been saved due to blocking certain transactions. Bandwidth units are displayed in Bytes

**Table 22-2 Report Column Descriptions (continued)**

<b>Column Name</b>	<b>Description</b>
Time Spent	<p>The amount of time spent on a web page. For purposes of investigating a user, the time spent by the user on each URL category. When tracking a URL, the time spent by each user on that specific URL.</p> <p>To calculate the time spent, AsyncOS assigns each active user with 60 seconds of time for activity during a minute. At the end of the minute, the time spent by each user is evenly distributed among the different domains the user visited. For example, if a user goes to four different domains in an active minute, the user is considered to have spent 15 seconds at each domain.</p> <p>For the purposes of the time spent value, considering the following notes:</p> <ul style="list-style-type: none"> <li>• An active user is defined as a username or IP address that sends HTTP traffic through the appliance and has gone to a website that AsyncOS considers to be a “page view.”</li> <li>• AsyncOS defines a page view as an HTTP request initiated by the user, as opposed to a request initiated by the client application. AsyncOS uses a heuristic algorithm to make a best effort guess to identify user page views.</li> </ul> <p>Units displayed in Hours:Minutes format.</p>
Allowed URL Category	The number and type of categories that have been allowed. Units displayed in transaction type.
Monitored URL Category	The number and type of categories that are being monitored. Units displayed in transaction type.
Warned URL Category	The number and type of categories that have initiated a warning. Units displayed in transaction type.
Blocked by URL Category	The transaction that has been blocked due to URL Category. Units displayed in transaction type.
Blocked by Application or Application Type	The application that has been blocked due to application type. Units displayed in transaction type.
Blocked by Web Reputation	The transaction that has been blocked due to web reputation. Units displayed in transaction type.
Blocked by Anti-Malware	The transactions blocked by Anti-Malware. Units displayed in transaction type.
Other Blocked Transactions	All other transactions that have been blocked. Units displayed in transaction type.
Transactions with Bandwidth Limit	The number of transactions that have a bandwidth limit.
Transactions without Bandwidth Limit	The number of transactions that do not have a bandwidth limit.
Transactions Blocked by Application	The number of transactions blocked by a specific application type.
Warned Transactions	All transactions that rendered a warning to the user. Units displayed in transaction type.

**Table 22-2** Report Column Descriptions (continued)

Column Name	Description
Transactions Completed	The transactions completed by a user. Units displayed in transaction type.
Transactions Blocked	All transactions that have been blocked. Units displayed in transaction type.
Total Transactions	The total number of transactions that have occurred.

## Configuring Columns on Report Pages

To configure the columns that appear in a report, perform the following steps:

- 
- Step 1** Choose **Reporting** > *Report\_Name*.
  - Step 2** Click the **Columns** link that appears in the lower right corner of a report.
  - Step 3** Select each column to display by clicking the checkbox next to each column in the pop-up window, and click **Done**.
- 

## Subdomains vs. Second-Level Domains in Reporting and Tracking

In reporting and tracking searches, second-level domains (regional domains listed at <http://george.surbl.org/two-level-tlds>) are treated differently from subdomains, even though the two domain types may appear to be the same. For example:

- Reports will not include results for a two-level domain such as `co.uk`, but will include results for `foo.co.uk`. Reports include subdomains under the main corporate domain, such as `cisco.com`.
- Tracking search results for the regional domain `co.uk` will not include domains such as `foo.co.uk`, while search results for `cisco.com` will include subdomains such as `subdomain.cisco.com`.

## Printing and Exporting Reports from Report Pages

You can generate a printer-friendly formatted PDF version of any of the report pages by clicking the **Printable (PDF)** link at the top-right corner of the page.

Additionally, you can export raw data as a comma-separated value (CSV) file by clicking the **Export** link. You can also save this data as CSV for most scheduled reports.

Because CSV exports include only raw data, exported data from a web-based report page may not include calculated data such as percentages, even if that data appears in the web-based report.



### Note

You can only print to PDF and export data from the Web Tracking page after the Web Tracking page returns search results. Do this using the **Printable Download** link. From this link you can choose to create a PDF that includes data displayed on the current page or up to 1,000 transactions, or you can export all data to a CSV file. If you display details, data for up to 100 related transactions is included in the PDF. The first 3000 characters are displayed for each related transaction.

## Exporting Report Data

Most reports include an **Export** link that allows you to export raw data to a comma-separated values (CSV) file. After exporting the data to a CSV file, you can access and manipulate the data in it using applications such as Microsoft Excel.

The exported CSV data displays all message tracking and reporting data in Greenwich Mean Time (GMT) regardless of what is set on the Web Security appliance. The purpose of the GMT time conversion is to allow data to be used independently from the appliance or when referencing data from appliances in multiple time zones.

The following example is an entry from a raw data export of the Anti-Malware category report, where Pacific Daylight Time (PDT) is displayed as GMT - 7 hours:

```
Begin Timestamp, End Timestamp, Begin Date, End Date, Name, Transactions Monitored,
Transactions Blocked, Transactions Detected
1159772400.0, 1159858799.0, 2006-10-02 07:00 GMT, 2006-10-03 06:59 GMT, Adware, 525,
2100, 2625
```

**Table 22-3** Viewing Raw Data Entries

Category Header	Value	Description
Begin Timestamp	1159772400.0	Query start time in number of seconds from epoch.
End Timestamp	1159858799.0	Query end time in number of seconds from epoch.
Begin Date	2006-10-02 07:00 GMT	Date the query began.
End Date	2006-10-03 06:59 GMT	Date the query ended.
Name	Adware	Name of the malware category.
Transactions Monitored	525	Number of transactions monitored.
Transactions Blocked	2100	Number of transactions blocked.
Transactions Detected	2625	Total number of transactions: Number of transactions detected + Number of transactions blocked.



**Note**

Category headers are different for each type of report.



**Note**

If you export localized CSV data, the headings may not be rendered properly in some browsers. This occurs because some browsers may not use the proper character set for the localized text. To work around this problem, you can save the file to your local machine, and open the file in any web browser using **File > Open**. When you open the file, select the character set to display the localized text.

# Enabling Centralized Reporting

When the Web Security appliance is managed by a Security Management appliance, you can choose which appliance displays reports on the web traffic that is processed by the Web Security appliance. By default, the Web Security appliance maintains the reports (Local Reporting). However, you can configure the Web Security appliance so that the Security Management appliance maintains the reports by enabling Centralized Reporting. You might want to enable Centralized Reporting when the Security Management appliance manages multiple Web Security appliances. This gives you a centralized view of web traffic across all Web Security appliances.

**Note**

When you enable Centralized Reporting, only the System Capacity and System Status reports are available on the Web Security appliance. To view the other reports, connect to the Security Management appliance. The Web Security appliance no longer stores data for the other reports.

To enable Centralized Reporting:

- Step 1** Navigate to the Security Services > Reporting page, and click **Edit Settings**.
- Step 2** Choose **Centralized Reporting**.
- Step 3** Submit and commit your changes.

## Scheduling Reports

You can schedule reports to run on a daily, weekly, or monthly basis. Scheduled reports can be configured to include data for the previous day, previous seven days, or previous month. Alternatively, you can include data for a custom number of days (from 2 days to 100 days) or a custom number of months (from 2 months to 12 months).

Regardless of when you run a report, the data is returned from the previous time interval (hour, day, week, or month). For example, if you schedule a daily report to run at 1AM, the report will contain data from the previous day, midnight to midnight (00:00 to 23:59).

You can schedule reports for the following types of reports:

- Overview
- Users
- Web Sites
- URL Categories
- Application Visibility
- Anti-Malware
- Client Malware Risk
- Web Reputation Filters
- L4 Traffic Monitor
- Reports by User Location
- System Capacity

For more information on the data displayed in each report, see [Web Security Appliance Reports, page 23-1](#).

## Adding a Scheduled Report

Use the Reporting > Scheduled Reports page to schedule reporting for different reports.

To create a scheduled report:

- 
- Step 1** Navigate to the **Reporting > Scheduled Reports** page, and click **Add Scheduled Report**.
  - Step 2** Select a report type.
  - Step 3** Enter a title for the report. To avoid creating multiple reports with the same name, consider using a descriptive title.
  - Step 4** Select a time range for the data included in the report.
  - Step 5** Choose the format for the generated report.  
The default format is PDF. Most reports also allow you to save raw data as a CSV file.
  - Step 6** Depending on the type of report you configure, you can specify different report options, such as the number of rows to include and by which column to sort the data. Configure these options as necessary.
  - Step 7** In the Schedule section, choose whether to run the report daily, weekly, or monthly and at what time.
  - Step 8** In the Email field, enter the email address to where to send the generated report.  
If you do not specify an email address, the report is archived only.
  - Step 9** Submit and commit your changes.

## Editing Scheduled Reports

To edit reports, select the report title from the list on the Reporting > Scheduled Reports page, modify settings then submit and commit your changes.

## Deleting Scheduled Reports

To delete reports, go to the Reporting > Scheduled Reports page and select the check boxes corresponding to the reports that you want to delete. To remove all scheduled reports, select the All check box, **Delete** and **Commit** your changes. Note that archived versions of deleted reports are not deleted.

## Generating Reports On Demand

The Generate Report Now option on the Reporting > Archived Reports page allows you to generate on-demand data displays for each report type.

- 
- Step 1** Navigate to the **Reporting > Archived Reports** page.
  - Step 2** Click **Generate Report Now**

- Step 3** Select a report type and edit the title, if necessary. To avoid creating multiple reports with the same name, consider using a descriptive title.
- Step 4** Select a time range for the data included in the report.
- Step 5** Choose the format for the generated report.  
The default format is PDF. Most reports also allow you to save raw data as a CSV file.
- Step 6** Depending on the type of report you configure, you can specify different report options, such as the number of rows to include and by which column to sort the data. Configure these options as necessary.
- Step 7** Select whether to archive the report (if so, the report will appear on the Archived Reports page).
- Step 8** Specify whether to email the report, and list the email addresses of the recipients.
- Step 9** Click **Deliver this Report** to generate the report.
- Step 10** Commit your changes.

## Archived Reports

The Reporting > Archived Reports page lists available archived reports. Report names in the Report Title column are interactive and link to a view of each report. The Show menu filters the types of reports that are listed. Additionally, interactive column headings can be used to sort the data in each column.

The appliance stores up to 12 instances of each scheduled report (up to 1000 reports). Archived reports are stored in the `/periodic_reports` directory on the appliance. Archived reports are deleted automatically. As new reports are added, older reports are removed to keep the number at 1000. The limit of 12 instances applies to each scheduled report with the same name and time range.

## SNMP Monitoring

The AsyncOS operating system supports system status monitoring via SNMP (Simple Network Management Protocol). This includes Cisco's Enterprise MIB, `asyncoswebsecurityappliance-mib.txt`. The `asyncoswebsecurityappliance-mib` helps administrators better monitor system health. In addition, this release implements a read-only subset of MIB-II as defined in RFCs 1213 and 1907. (For more information about SNMP, see RFCs 1065, 1066, and 1067.) Please note:

- SNMP requests are serviced on the P1 interface.
- SNMP is **off** by default.
- SNMP SET operations (configuration) are not implemented.
- AsyncOS supports SNMPv1, v2, and v3.
- The use of SNMPv3 with password authentication and DES Encryption is mandatory to enable this service. (For more information on SNMPv3, see RFCs 2571-2575.) You are required to set a SNMPv3 passphrase of at least 8 characters to enable SNMP system status monitoring. The first time you enter a SNMPv3 passphrase, you must re-enter it to confirm. The `snmpconfig` command "remembers" this phrase the next time you run the command.
- The SNMPv3 username is: `v3get`.

```
> snmpwalk -v 3 -l AuthNoPriv -u v3get -a MD5 ironport serv.example.com
```



- If you use only SNMPv1 or SNMPv2, you must set a community string. The community string does not default to `public`.
- For SNMPv1 and SNMPv2, you must specify a network from which SNMP GET requests are accepted.
- To use traps, an SNMP manager (not included in AsyncOS) must be running and its IP address entered as the trap target. (You can use a hostname, but if you do, traps will only work if DNS is working.)

Use the `snmpconfig` command to configure SNMP system status for the appliance. After you choose and configure values for an interface, the appliance responds to SNMPv3 GET requests. These version 3 requests must include a matching password. By default, version 1 and 2 requests are rejected. If enabled, version 1 and 2 requests must have a matching community string.

## MIB Files

Cisco provides “enterprise” MIBs for Email and Web Security appliances as well as a “Structure of Management Information” (SMI) file:

- `asyncoswebsecurityappliance-mib.txt` — an SNMPv2 compatible description of the Enterprise MIB for Web Security appliances.
- `ASYNOS-MAIL-MIB.txt` — an SNMPv2 compatible description of the Enterprise MIB for Email Security appliances.
- `IRONPORT-SMI.txt` — defines the role of the `asyncoswebsecurityappliance-mib`.

These files are available on the documentation CD included with your IronPort appliance. You can also find these files here:

[http://www.cisco.com/en/US/customer/products/ps10164/tsd\\_products\\_support\\_series\\_home.html](http://www.cisco.com/en/US/customer/products/ps10164/tsd_products_support_series_home.html)

## Hardware Objects

Hardware sensors conforming to the Intelligent Platform Management Interface Specification (IPMI) report temperature, fan speed, and power supply status.

Table 22-4 shows what hardware derived objects are available for monitoring on what models. The number displayed is the number of instances of that object that can be monitored. For example, you can query the RPMs for 4 fans in the S350 appliance.

**Table 22-4** Number of Hardware Objects per Appliance

Model	Ambient Temp	Fans	Power Supply	Disk Status	NIC Link
<b>S160</b>	1	2	1	2	6
<b>S350</b>	1	4	2	6	6
<b>S360</b>	1	4	2	4	6
<b>S650</b>	1	4	2	6	6
<b>S660</b>	1	4	2	6	6

## Hardware Traps

Table 22-5 lists the temperature and hardware conditions that cause a hardware trap to be sent:

**Table 22-5** *Hardware Traps: Temperature and Hardware Conditions*

Model	High Temp (Ambient)	Fan Failure	Power Supply	RAID	Link
<b>S160/S350/S360/S650/S660</b>	47C	0 RPMs	Status Change	Status Change	Status Change

Status change traps are sent when the status changes. Fan Failure and high temperature traps are sent every 5 seconds. The other traps are failure condition alarm traps — they are sent once when the state changes (healthy to failure). It is a good idea to poll for the hardware status tables and identify possible hardware failures before they become critical. Temperatures within 10 per cent of the critical value may be a cause for concern.

Note that failure condition alarm traps represent a critical failure of the individual component, but may not cause a total system failure. For example, a single fan or power supply can fail on a S650 appliance and the appliance will continue to operate.

## SNMP Traps

SNMP provides the ability to send traps, or notifications, to advise an administration application (an SNMP management console, typically) when one or more conditions have been met. Traps are network packets that contain data relating to a component of the system sending the trap. Traps are generated when a condition has been met on the SNMP agent (in this case, the IronPort appliance). After the condition has been met, the SNMP agent then forms an SNMP packet and sends it over port 162, the standard SNMP trap port. In the example below, the trap target of 10.1.1.29 and the Trap Community string are entered. This is the host running the SNMP management console software that will receive the SNMP traps from the appliance.

You can configure SNMP traps (enable or disable specific traps) when you enable SNMP for an interface. To specify multiple trap targets: when prompted for the trap target, you may enter up to 10 comma separated IP addresses.

## CLI Example

In the following example, the `snmpconfig` command is used to enable SNMP on the “PublicNet” interface on port 161. A passphrase for version 3 is entered and then re-entered for confirmation. The system is configured to service version 1 and 2 requests, and the community string `public` is entered for GET requests from those versions 1 and 2. The trap target of 10.1.1.29 is entered. Finally, system location and contact information is entered.

```
example.com> snmpconfig
```

```
Current SNMP settings:
```

```
SNMP Disabled.
```

Choose the operation you want to perform:

- SETUP - Configure SNMP.

[ ]> **setup**

Do you want to enable SNMP? [N]> **y**

Please choose an IP interface for SNMP requests.

1. Management (192.168.1.1/24: wsa01-vmw1-tpub.qa)

[1]>

Enter the SNMPv3 passphrase.

>

Please enter the SNMPv3 passphrase again to confirm.

>

Which port shall the SNMP daemon listen on?

[161]>

Service SNMP V1/V2c requests? [N]> **y**

Enter the SNMP V1/V2c community string.

[ ]> **public**

From which network shall SNMP V1/V2c requests be allowed?

[192.168.1.1]>

Enter the Trap target as a host name, IP address or list of IP addresses separated by commas (IP address preferred). Enter "None" to disable traps.

[None]> **10.1.1.29**

Enter the Trap Community string.

```
[> tcomm
```

Enterprise Trap Status

1. CPUUtilizationExceeded	Disabled
2. RAIDStatusChange	Enabled
3. connectivityFailure	Disabled
4. fanFailure	Enabled
5. highTemperature	Enabled
6. keyExpiration	Enabled
7. linkDown	Enabled
8. linkUp	Enabled
9. memoryUtilizationExceeded	Disabled
10. powerSupplyStatusChange	Enabled
11. resourceConservationMode	Enabled
12. updateFailure	Enabled
13. upstream_proxy_failure	Enabled

Do you want to change any of these settings? [N]> **y**

Do you want to disable any of these traps? [Y]> **n**

Do you want to enable any of these traps? [Y]> **y**

Enter number or numbers of traps to enable. Separate multiple numbers with commas.

```
[> 1,3
```

What threshold would you like to set for CPU utilization?

```
[95]>
```

What URL would you like to check for connectivity failure?

[http://downloads.ironport.com]>

Enterprise Trap Status

1. CPUUtilizationExceeded	Enabled
2. RAIDStatusChange	Enabled
3. connectivityFailure	Enabled
4. fanFailure	Enabled
5. highTemperature	Enabled
6. keyExpiration	Enabled
7. linkDown	Enabled
8. linkUp	Enabled
9. memoryUtilizationExceeded	Disabled
10. powerSupplyStatusChange	Enabled
11. resourceConservationMode	Enabled
12. updateFailure	Enabled
13. upstream_proxy_failure	Enabled

Do you want to change any of these settings? [N]>

Enter the System Location string.

[Unknown: Not Yet Configured]> **Network Operations Center - west; rack #30, position 3**

Enter the System Contact string.

[snmp@localhost]> **Joe Administrator, x8888**

Current SNMP settings:

Listening on interface "Management" 192.168.1.1 port 161.

SNMP v3: Enabled.

```
SNMP v1/v2: Enabled, accepting requests from subnet 192.168.1.1.
```

```
SNMP v1/v2 Community String: public
```

```
Trap target: 10.1.1.29
```

```
Location: Network Operations Center - west; rack #30, position 3
```

```
System Contact: Joe Administrator, x8888
```

```
Choose the operation you want to perform:
```

```
- SETUP - Configure SNMP.
```

```
[ ]>
```

```
example.com>
```

# 23

## Web Security Appliance Reports

---

- [Overview Page, page 23-1](#)
- [Users Page, page 23-5](#)
- [User Details Page, page 23-6](#)
- [Web Sites Page, page 23-8](#)
- [URL Categories Page, page 23-10](#)
- [Application Visibility Page, page 23-13](#)
- [Anti-Malware Page, page 23-15](#)
- [Client Malware Risk Page, page 23-19](#)
- [Web Reputation Filters Page, page 23-22](#)
- [L4 Traffic Monitor Page, page 23-24](#)
- [SOCKS Proxy Page, page 23-28](#)
- [Reports by User Location Page, page 23-30](#)
- [Web Tracking Page, page 23-32](#)
- [System Capacity Page, page 23-36](#)
- [System Status Page, page 23-38](#)

### Overview Page

The **Reporting > Overview** page provides a synopsis of the activity on the Web Security appliance. It includes graphs and summary tables for web traffic processed by the Web Security appliance.

[Figure 23-1](#) shows the Overview page.

Figure 23-1 The Overview Page

Overview

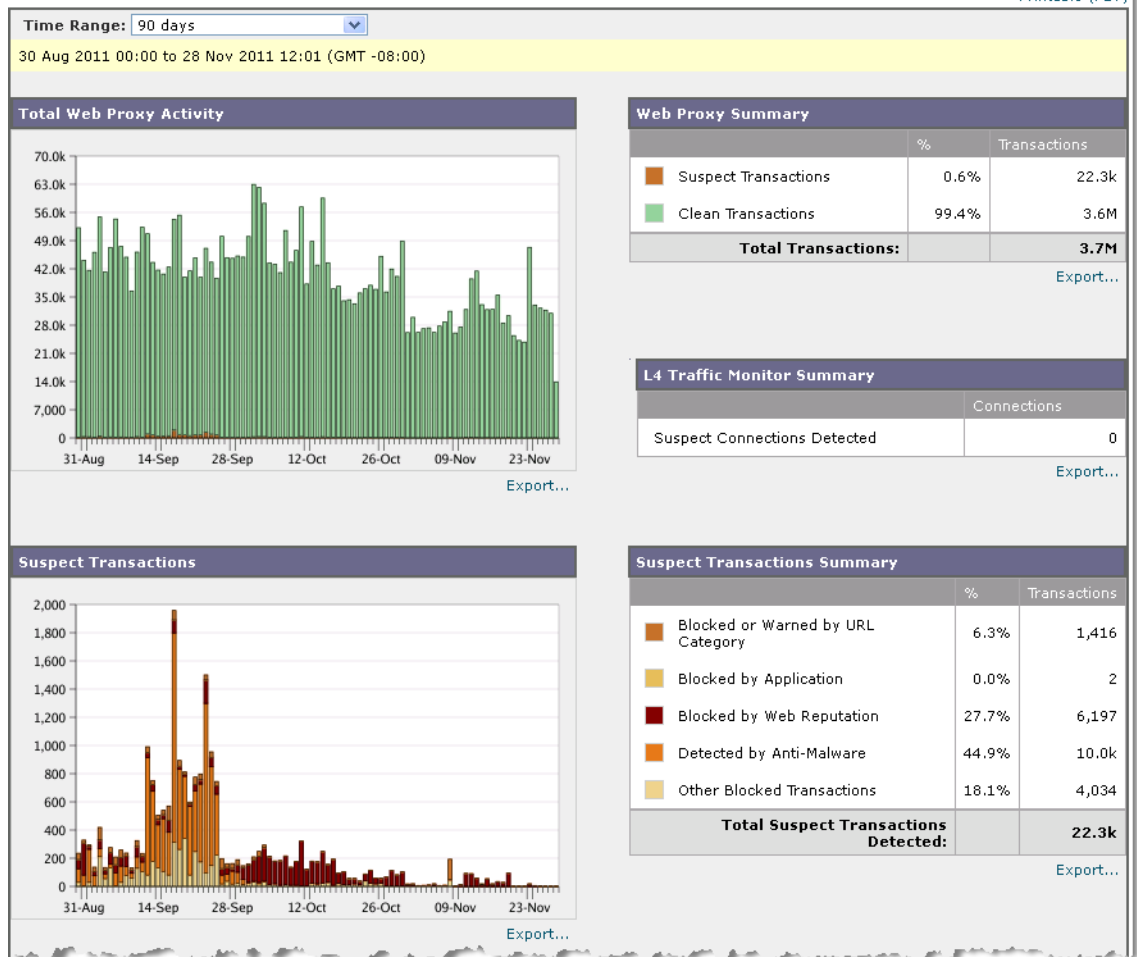

(Illustration continues on next page.)



(Illustration continued from previous page.)

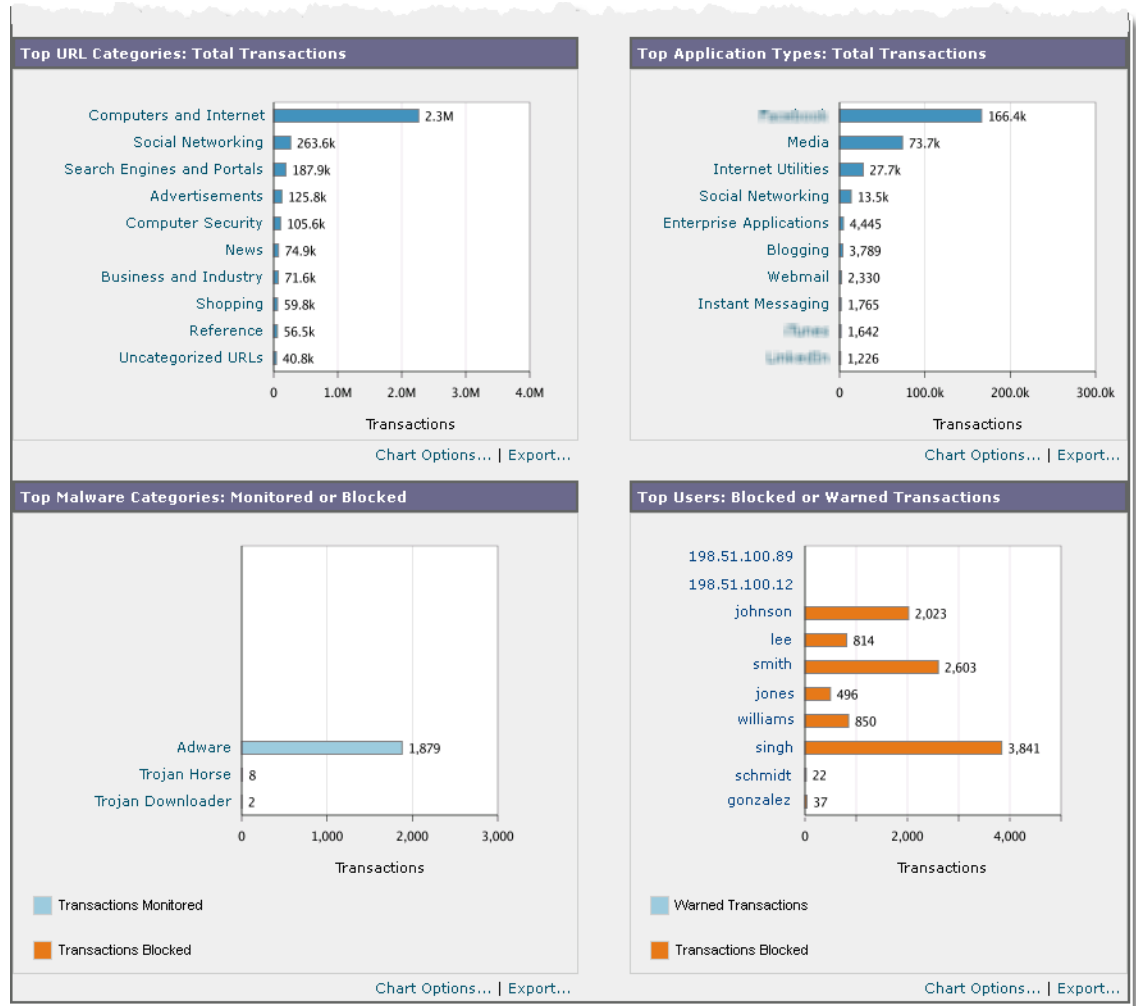

At a high level the **Overview** page shows you statistics about the URL and User usage, Web Proxy activity, and various transaction summaries. The transaction summaries gives you further trending details on, for example suspect transactions, and right across from this graph, how many of those suspect transactions are blocked and in what manner they are being blocked.

The lower half of the **Overview** page is about usage. That is, the top URL categories being viewed, the top application types and categories that are being blocked, and the top users that are generating these blocks or warnings.

Table 23-1 describes the information on the Overview page.

**Table 23-1 Overview Report Page Components**

Section	Description
<b>Time Range (drop-down list)</b>	A menu that allows to choose the time range of the data contained in the report. For more information, see the <a href="#">“Changing the Time Range”</a> section on page 22-2.
<b>Total Web Proxy Activity</b>	This section displays the Web Proxy activity. This section displays the actual number of transactions (vertical scale) as well as the approximate date that the activity occurred (horizontal timeline).
<b>Web Proxy Summary</b>	This section allows you to view the percentage of Web Proxy activity that are suspect, or clean Web Proxy activity, including the total number of transactions.
<b>L4 Traffic Monitor Summary</b>	This section reports on traffic monitored and blocked by the L4 Traffic Monitor.
<b>Suspect Transactions</b>	This section allows you to view the web transactions that have been labeled as suspect by the various security components.  This section displays the actual number of transactions (vertical scale) as well as the approximate date that the activity occurred (horizontal timeline).
<b>Suspect Transactions Summary</b>	This section allows you to view the percentage of blocked or warned transactions that are suspect. Additionally, you can see the type of transactions that have been detected and blocked, and the actual number of times that this transaction was blocked.
<b>Top URL Categories by Total Transactions</b>	This section displays the top 10 URL categories that have been blocked. (URL category on the vertical scale by the number of times requests in that category were blocked on the horizontal scale.)  The set of predefined URL categories is occasionally updated. For more information about the impact of these updates on report results, see <a href="#">URL Category Set Updates and Reports</a> , page 23-12.
<b>Top Application Types by Total Transactions</b>	This section displays the top application types that have been blocked by the AVC engine. (The application type on the vertical scale by the number of times requests for applications in that type were blocked on the horizontal scale.)
<b>Top Malware Categories Detected</b>	This section displays all malware categories that have been detected.
<b>Top Users Blocked or Warned Transactions</b>	This section displays the users that are generating the blocked or warned transactions. Authenticated users are displayed username and unauthenticated users are displayed by IP address.  You can choose to make usernames unrecognizable in reports. For more information on how to do this, see the <a href="#">“Working with Usernames in Reports”</a> section on page 22-1.

# Users Page

The **Reporting > Users** page provides several links that allows you to view web traffic information for individual users. You can view how much time users on the network have spent on the Internet or on a particular website or URL, and how much bandwidth users have used.

Figure 23-2 shows the Users page.

**Figure 23-2 The Users Page**

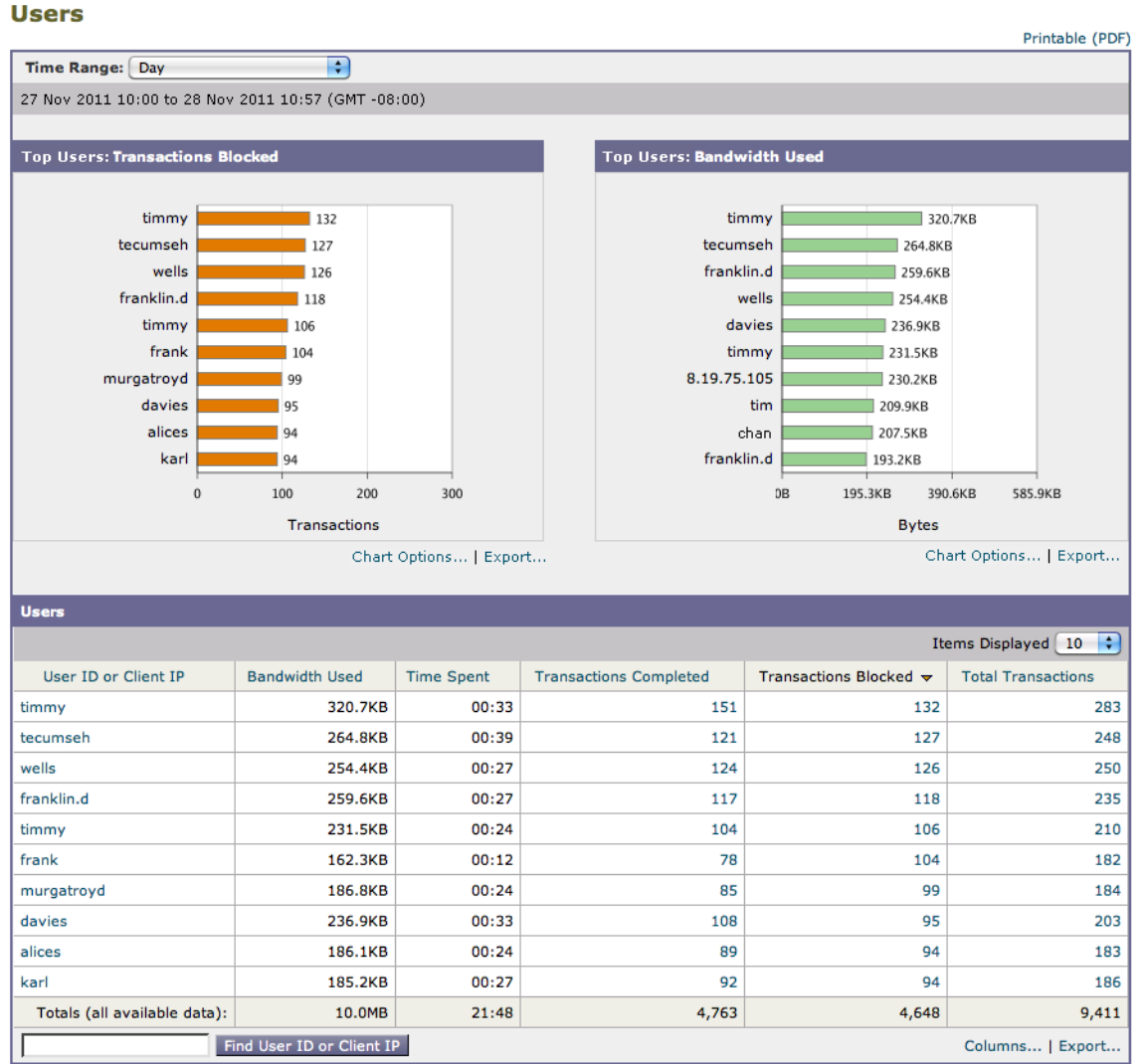

Table 23-2 describes the information on the Users page.

**Table 23-2 Users Report Page Components**

Section	Description
<b>Time Range (drop-down list)</b>	A menu that allows to choose the time range of the data contained in the report. For more information, see the <a href="#">“Changing the Time Range” section on page 22-2</a> .
<b>Top Users by Transactions Blocked</b>	This section lists the users (vertical scale) that have the greatest number of blocked transactions (horizontal scale).  Authenticated users are displayed username and unauthenticated users are displayed by IP address. You can choose to make usernames unrecognizable in reports. For more information on how to do this, see the <a href="#">“Working with Usernames in Reports” section on page 22-1</a> .
<b>Top Users by Bandwidth Used</b>	This sections displays the users (vertical scale) that are using the most bandwidth on the system (horizontal scale represented in gigabyte usage).
<b>Users Table</b>	The Users Table lists individual users and displays multiple statistics on each user. You can sort the table by clicking the column headers, and choose which columns of data to display. For more information, see <a href="#">Working with Columns on Report Pages, page 22-4</a> .  When the section contains more than 10 users, you can use the <b>Items Displayed</b> menu to configure the number of users to display.  You can search for data on a specific user in the <b>Find User ID or Client IP Address</b> field. For more information, see <a href="#">Searching Data, page 22-3</a> .  You can click on a user in the table to find more specific information. This information appears on the User Details page. For more information, see the <a href="#">“User Details Page” section on page 23-6</a> .

## User Details Page

The **User Details** page displays information about a specific user selected in the Users Table on the **Reporting > Users** page.

The **User Details** page allows you to investigate individual user’s activity on the network. You might want to view this information if you need to run user-level investigations and need to find out, for example, what sites users are visiting, what malware threats they are encountering, what URL categories they are accessing, and how much time each user spends at these sites.

To display the **User Details** page for a user, click on the user from the User Table on the **Reporting > Users** page. [Table 23-3](#) describes the information on the User Details page.

**Table 23-3** *User > User Details Report Page Components*

Section	Description
<b>Time Range (drop-down list)</b>	A menu that allows to choose the time range of the data contained in the report. For more information, see the <a href="#">“Changing the Time Range” section on page 22-2</a> .
<b>URL Categories by Total Transactions</b>	<p>This section lists the specific URL categories that a specific user is using.</p> <p>The set of predefined URL categories is occasionally updated. For more information about the impact of these updates on report results, see <a href="#">URL Category Set Updates and Reports, page 23-12</a>.</p>
<b>Trend by Total Transaction</b>	<p>This graph displays at what times the user accessed the web.</p> <p>For example, this graph will indicate if there is a large spike in web traffic during certain hours of the day, and when those spikes occur. Using the Time Range drop-down list, you can expand this graph to see a more or less granular span of time that this user was on the web.</p>
<b>URL Categories Matched</b>	<p>This section shows all matched URL categories during a specified time range for both completed and blocked transactions. You can use column headings to sort data. When the section contains more than 10 categories, you can use the <b>Items Displayed</b> menu to configure the number of URL categories to display.</p> <p>The set of predefined URL categories is occasionally updated. For more information about the impact of these updates on report results, see <a href="#">URL Category Set Updates and Reports, page 23-12</a>.</p> <p>From this section you can also search for data that applies to a specific URL category in the <b>Find URL Category</b> field. For more information, see <a href="#">Searching Data, page 22-3</a>.</p>
<b>Domains Matched</b>	<p>From this section you can find out about a specific Domain or IP address that this user has accessed. You can also see the time spent on those categories, and various other information that you have set from the column view. In the text field at the bottom of the section enter the Domain or IP address and click <b>Find Domain or IP</b>. The domain or IP address does not need to be an exact match.</p>
<b>Applications Matched</b>	<p>From this section you can find a specific application that a specific user is using as detected by the AVC engine. For example, if a user is accessing a site that requires use of a lot of Flash video, you will see the application type in the Application column.</p> <p>In the text field at the bottom of the section enter the application name and click <b>Find Application</b>. The name of the application does not need to be an exact match.</p>

Table 23-3 User &gt; User Details Report Page Components (continued)

Section	Description
<b>Malware Threats Detected</b>	From this table you can see the top malware threats that a specific user is triggering. In the text field at the bottom of the Malware Threats section, enter the malware threat name and click <b>Find Malware Threat</b> . The name of the malware threat does not need to be an exact match.
<b>Policies Matched</b>	From this section you can find a specific policy that is being enforced on this particular user.  From this section you can also search for data that applies to a specific policy in the <b>Find Policy</b> field. For more information, see <a href="#">Searching Data, page 22-3</a> .

**Note**

The client reports sometimes show a user with an asterisk (\*) at the end of the username. For example, the Client report might show an entry for both “jsmith” and “jsmith\*”. Usernames listed with an asterisk (\*) indicate the username provided by the user, but not confirmed by the authentication server. This happens when the authentication server was not available at the time and the appliance is configured to permit traffic when authentication service is unavailable.

## Web Sites Page

The **Reporting > Web Sites** page is an overall aggregation of the activity that is happening on the Web Security appliance. From this page you can monitor high-risk web sites accessed during a specific time range.

[Figure 23-3](#) shows the Web Sites page:

Figure 23-3 Web Sites Page

## Web Sites

Printable (PDF)

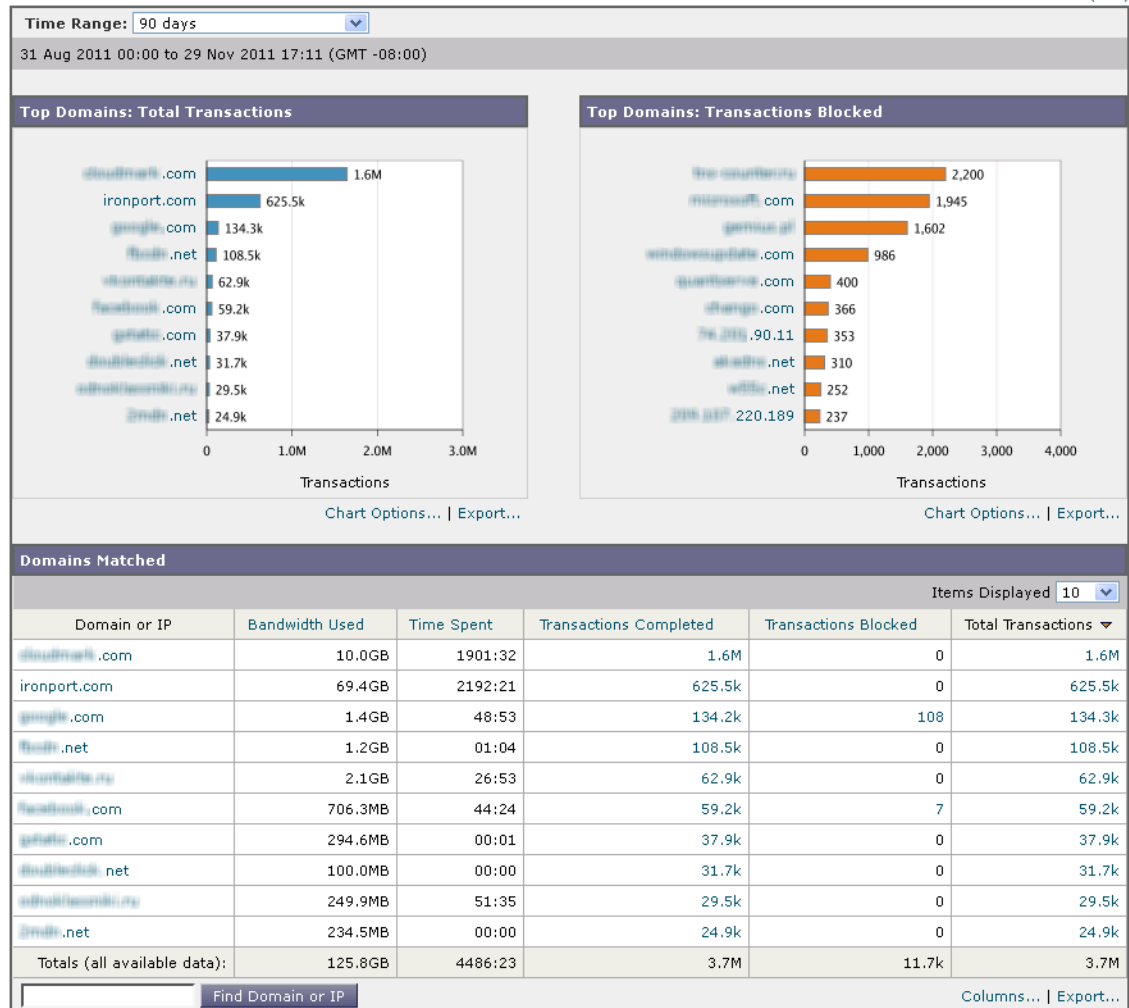

Table 23-4 describes the information on the **Web Sites** page:

**Table 23-4 Web Sites Report Page Components**

Section	Description
<b>Time Range (drop-down list)</b>	A menu that allows to choose the time range of the data contained in the report. For more information, see the <a href="#">“Changing the Time Range”</a> section on page 22-2.
<b>Top Domains by Total Transactions</b>	This section lists the top domains that are being visited on the site in a graph format.

Table 23-4 Web Sites Report Page Components (continued)

Section	Description
<b>Top Domains by Transactions Blocked</b>	This section lists the top domains that triggered a block action to occur per transaction in a graph format. For example, a user went to a certain domain and because of a specific policy that I have in place, this triggered a block action. This domain then gets listed in this graph as a transaction blocked, and the domain site that triggered the block action is listed.
<b>Domains Matched</b>	<p>This section lists the domains that are that are being visited on the site in an interactive table. From this table you can access more granular information about a specific domain by clicking on the specific domain. The Proxy Services tab on the Web Tracking page appears and you can see tracking information and why certain domains were blocked.</p> <p>You can use column headings to sort data, and you can choose which columns to display. For more information, see the <a href="#">“Working with Columns on Report Pages”</a> section on page 22-4.</p> <p>When the section contains more than 10 domains, you can use the <b>Items Displayed</b> menu to configure the number of domains to display.</p> <p>When you click on a specific domain you can see the top users of that domain, the top transactions on that domain, the URL categories matched and the malware threats that have been detected. This table can be modified using the Time Range drop-down list so you can see a specific time range, such as hour, day or week for that domain use.</p>

## URL Categories Page

The **Reporting > URL Categories** page can be used to view the URL categories that are being visited by users on the network.



### Note

The set of predefined URL categories is occasionally updated. For more information about the impact of these updates on report results, see [URL Category Set Updates and Reports, page 23-12](#).

[Figure 23-4](#) shows the URL Categories page.



Figure 23-4 URL Categories Page

URL Categories

Printable (PDF)

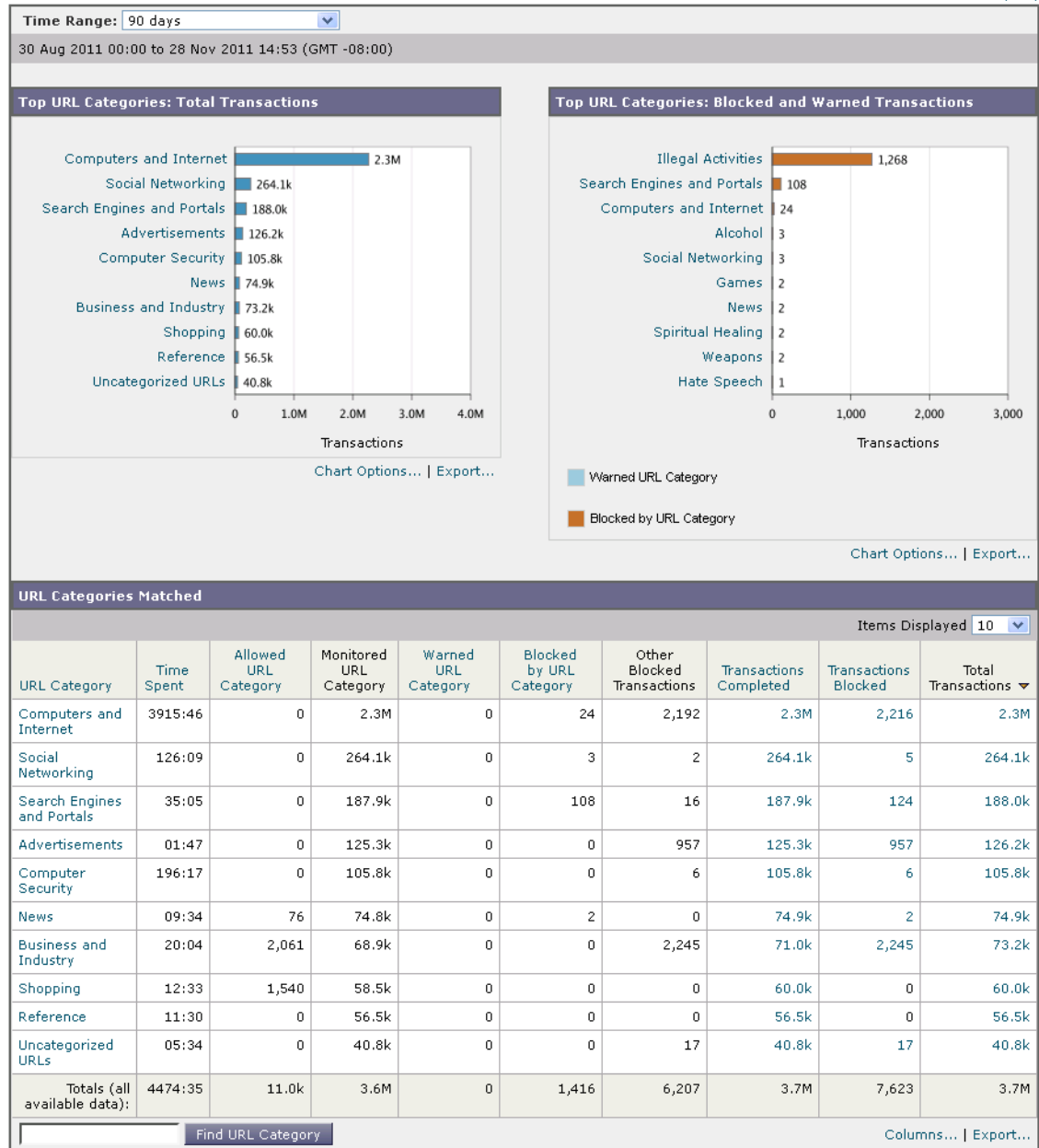

Table 23-5 describes the information on the URL Categories page.

Table 23-5 URL Categories Report Page Components

Section	Description
<b>Time Range (drop-down list)</b>	Choose the time range for your report. For more information, see the “Changing the Time Range” section on page 22-2.
<b>Top URL Categories by Total Transactions</b>	This section lists the top URL categories that are being visited on the site in a graph format.

**Table 23-5 URL Categories Report Page Components (continued)**

Section	Description
<b>Top URL Categories by Blocked and Warned Transactions</b>	This section lists the top URL that triggered a block or warning action to occur per transaction in a graph format. For example, a user went to a certain URL and because of a specific policy that is in place, this triggered a block action or a warning. This URL then gets listed in this graph as a transaction blocked or warning.
<b>URL Categories Matched</b>	<p>The URL Categories Matched section shows the disposition of transactions by URL category during the specified time range, plus bandwidth used and time spent in each category.</p> <p>If the percentage of uncategorized URLs is higher than 15-20%, consider the following options:</p> <ul style="list-style-type: none"> <li>• For specific localized URLs, you can create custom URL categories and apply them to specific users or group policies. For more information, see the <a href="#">“Creating and Editing Custom URL Categories”</a> section on page 17-15.</li> <li>• You can report uncategorized and misclassified and URLs to the Cisco for evaluation and database update. See <a href="#">Reporting Uncategorized and Misclassified URLs</a>, page 17-3.</li> <li>• Verify that Web Reputation Filtering and Anti-Malware Filtering are enabled. Often times, the correlation between malware and URLs with suspect content is high and it is likely that they may get caught by subsequent filters. The system pipeline is set up to catch malicious traffic with other downstream filters if URL filtering does not have a verdict.</li> </ul>

## URL Category Set Updates and Reports

The set of predefined URL categories may periodically be updated automatically on your Web Security appliance, as described in [Managing Updates to the Set of URL Categories](#), page 17-4.

When these updates occur, old category names will continue to appear in reports until the data associated with the older categories is too old to be included in reports. Report data generated after a URL category set update will use the new categories, so you may see both old and new categories in the same report.

If there is overlap between the contents of old and new categories, you may need to examine report results more carefully to obtain valid statistics. For example, if the “Instant Messaging” and “Web-based Chat” categories have been merged into a single “Chat and Instant Messaging” category during the time frame that you are looking at, visits before the merge to sites covered by the “Instant Messaging” and “Web-based Chat” categories are not counted in the total for “Chat and Instant Messaging”. Likewise, visits to instant messaging or Web-based chat sites after the merge would not be included in the totals for the “Instant Messaging” or “Web-based Chat” categories.

## Using The URL Categories Page in Conjunction with Other Reporting Pages

One of the advantages of the URL Categories page is that it can be used in conjunction with the [Application Visibility Page](#) and the [Users Page](#) to investigate a particular user, but also what types of applications or websites that a particular user is trying to access.

For example, from the [URL Categories Page](#) you can generate a high level report for Human Resources which details all the URL categories that are visited by the site. From the same page, you can gather further details in the URL Categories interactive table about the URL category 'Streaming Media'. By clicking on the Streaming Media category link, you can view the specific URL Categories report page. This page not only displays the top users that are visiting streaming media sites (in the Top Users by Category for Total Transactions section), but also displays the domains that are visited (in the Domains Matched interactive table) such as YouTube.com or QuickPlay.com.

At this point, you are getting more and more granular information for a particular user. Now, let's say this particular user stands out because of their usage, and you want to find out exactly what they are accessing. From here you can click on the user in the Users table. This action takes you to the [User Details Page](#), where you can view the user trends for that user, and find out exactly what they have been doing on the web.

If you wanted to go further, you can now view web tracking details by clicking on Transactions Completed link in the interactive table. This brings up the [Searching for Transactions Processed by the Web Proxy](#) on the Web Tracking Page where you can see the actual details about what dates the user accessed the sites, the full URL, the time spent on that URL, etc.

## Application Visibility Page

The **Reporting > Application Visibility** page shows the applications and application types used and blocked as detected by the Application Visibility and Control engine.

[Figure 23-5](#) shows the Application Visibility page.

Figure 23-5 Application Visibility Page

Application Visibility

Printable (PDF)

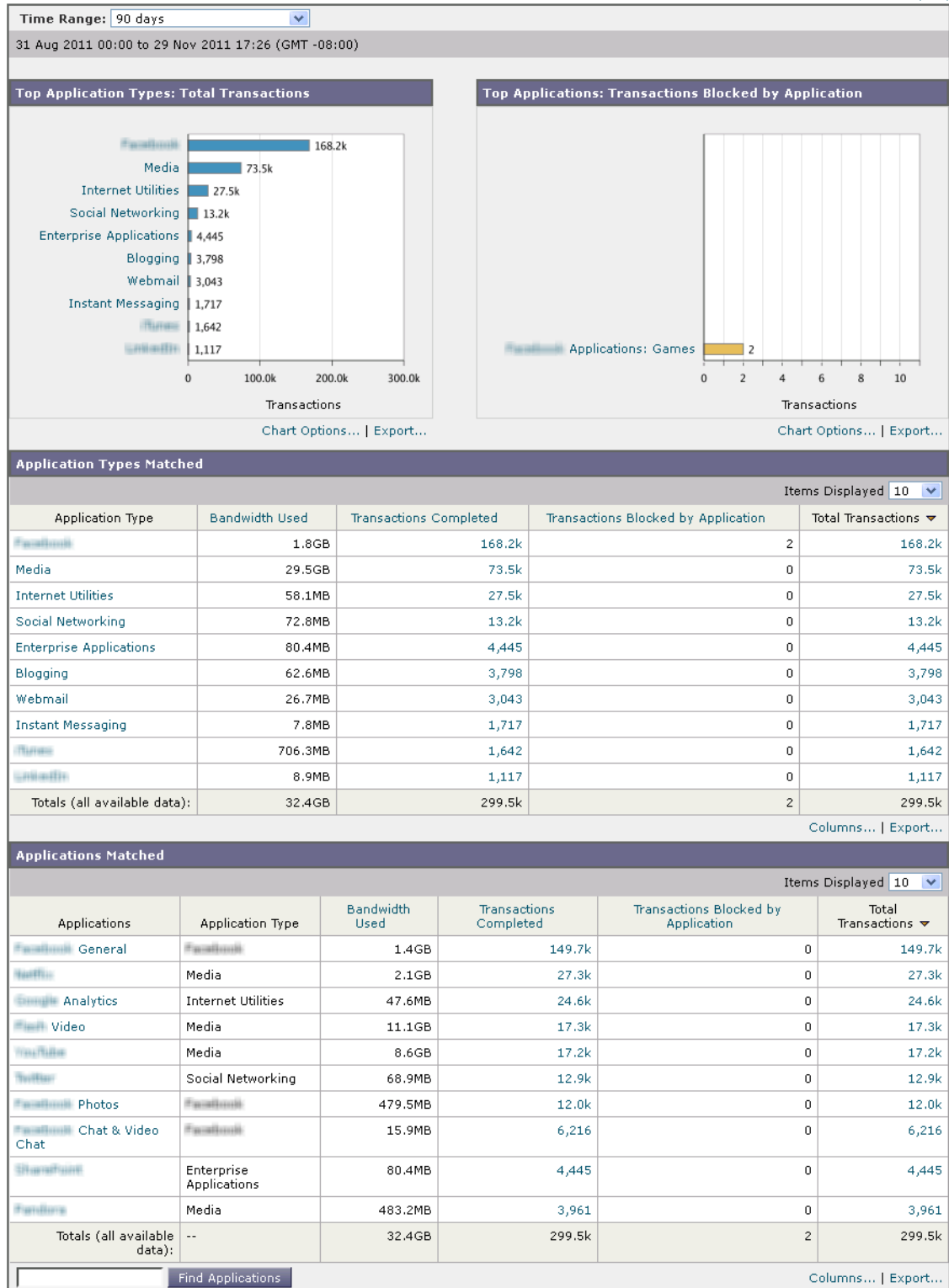

Table 23-6 describes the information on the Application Visibility page.

**Table 23-6 Application Visibility Report Page Components**

Section	Description
<b>Time Range (drop-down list)</b>	A menu that allows to choose the time range of the data contained in the report. For more information, see the <a href="#">“Changing the Time Range” section on page 22-2</a> .
<b>Top Application Types by Total Transactions</b>	This section lists the top application types that are being visited on the site in a graph format. For example, Instant Messaging tools such as Yahoo Instant Messenger, and Presentation application types.
<b>Top Applications by Blocked Transactions</b>	This section lists the top application types that triggered a block action to occur per transaction in a graph format. For example, a user has tried to start a certain application, such as Google Talk, and because of a configured policy, this triggered a block action. This application then gets listed in this graph as a transaction blocked or warning.
<b>Application Types Matched</b>	The Application Types Matched table allows you to view granular details about the application types listed in the Top Applications Type by Total Transactions graph. From the Applications column you can click on an application to view details.
<b>Applications Matched</b>	<p>The Applications Matched section shows all the application during a specified time range.</p> <p>You can sort the table by clicking the column headers, and choose which columns of data to display. For more information, see <a href="#">Working with Columns on Report Pages, page 22-4</a>.</p> <p>When the section contains more than 10 applications, you can use the <b>Items Displayed</b> menu to configure the number of applications to display.</p> <p>You can search for data on a specific application in the <b>Find Application</b> field. For more information, see <a href="#">Searching Data, page 22-3</a>.</p>

## Anti-Malware Page

The **Reporting > Anti-Malware** page allows you to monitor and identify malware detected by the Cisco IronPort DVS engine.

Figure 23-6 shows the Anti-Malware page.

Figure 23-6 Anti-Malware Page

Anti-Malware

Printable (PDF)

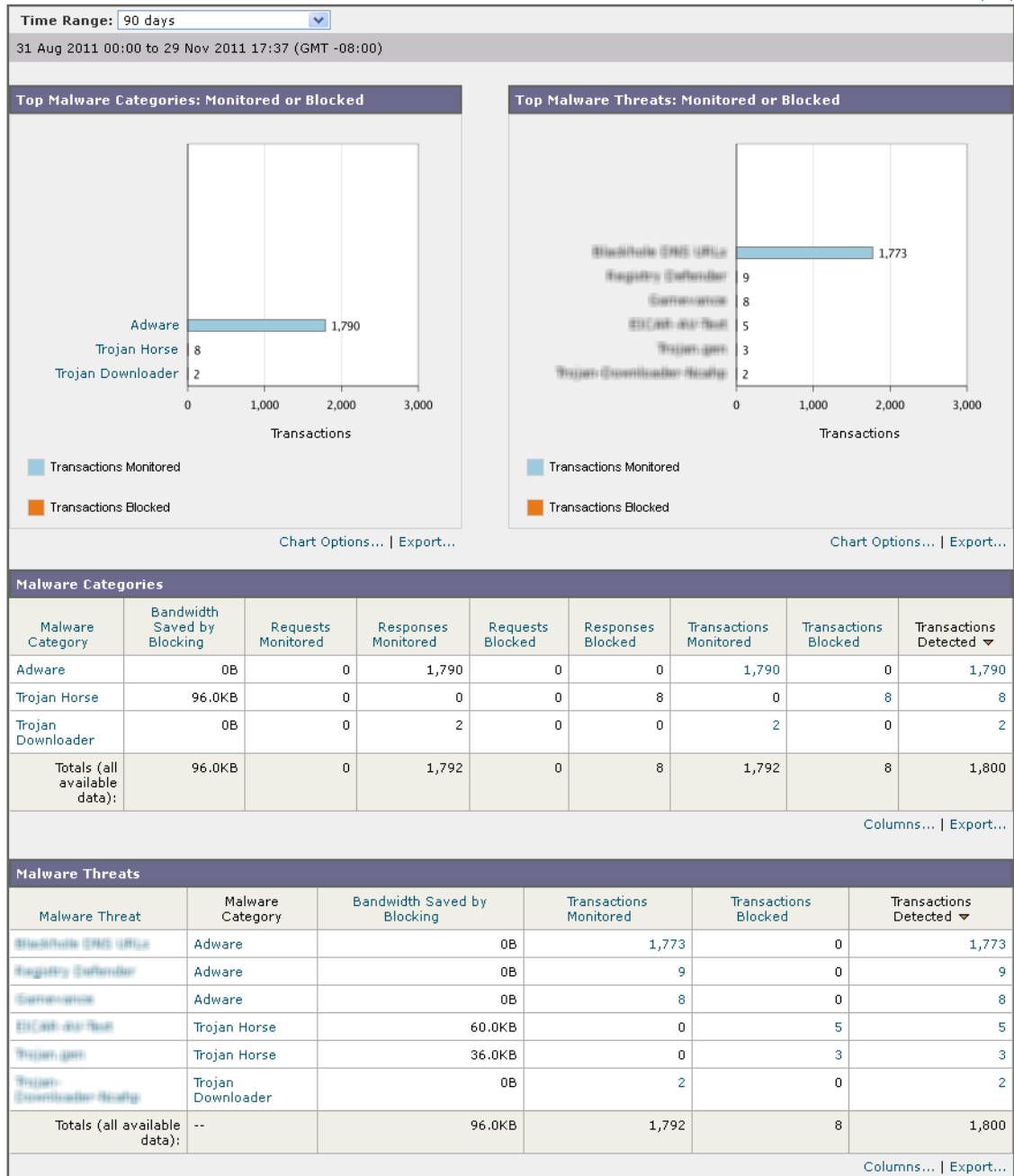

Table 23-7 describes the information on the Anti-Malware page.

**Table 23-7 Anti-Malware Report Page Components**

Section	Description
<b>Time Range (drop-down list)</b>	A menu that allows to choose the time range of the data contained in the report. For more information, see the <a href="#">“Changing the Time Range” section on page 22-2</a> .
<b>Top Malware Categories Detected</b>	This section displays the top malware categories detected by the DVS engine. This information is displayed in graph format.
<b>Top Malware Threats Detected</b>	This section displays the top malware threats detected by the DVS engine. This information is displayed in graph format.
<b>Malware Categories</b>	<p>The Malware Categories table shows detailed information about particular malware categories that are displayed in the Top Malware Categories Detected section.</p> <p>Clicking on any of the links in this table allows you to view more granular details about individual malware categories and where they are on the network.</p>
<b>Malware Threats</b>	<p>The Malware Threats table shows detailed information about particular malware threats that are displayed in the Top Malware Threats section.</p> <p>Threats labeled “Outbreak” with a number are threats identified by the Adaptive Scanning feature independently of other scanning engines.</p> <p><b>Note</b> When sorting the table by Malware Threat in ascending order, Unnamed Malware appears at the top of the list.</p>

## Malware Category Report Page

The Malware Category Report page allows you to view detailed information on an individual Malware Category and what it is doing on your network.

- 
- Step 1** Navigate to the **Reporting > Anti-Malware** page.
- Step 2** In the Malware Categories interactive table, click on a category in the Malware Category column.
-

Figure 23-7 Malware Category Report Page

## Malware Category

Adware

Printable (PDF)

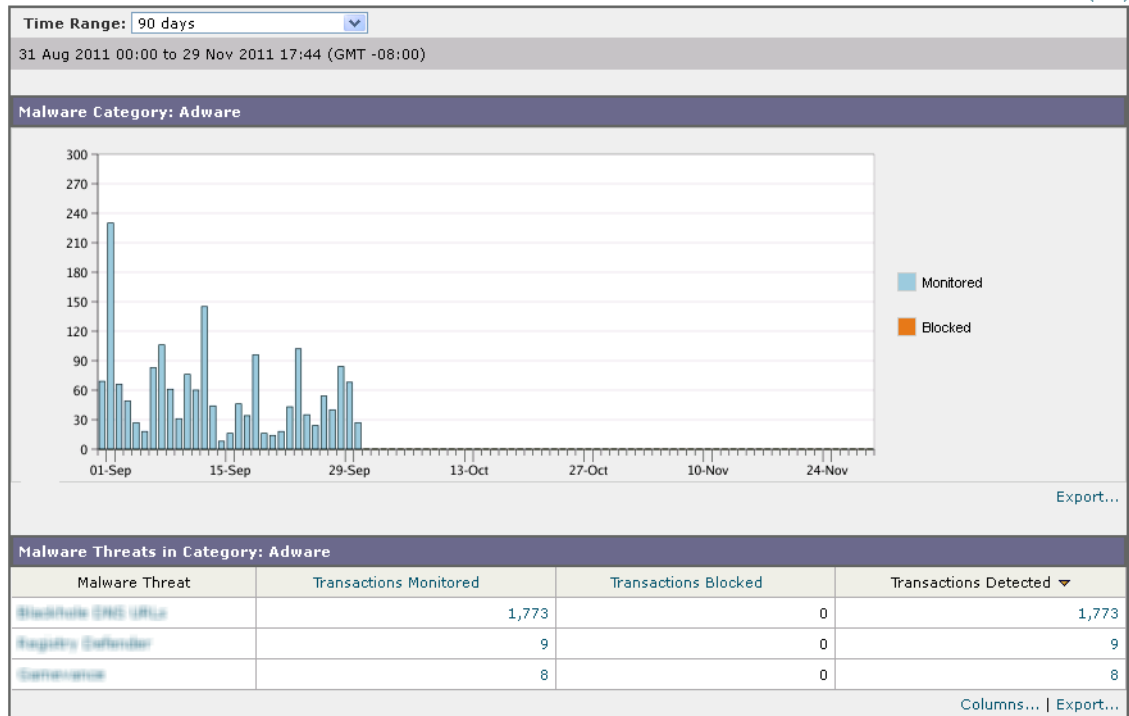

## Malware Threat Report Page

The Malware Threat Report page report shows clients at risk for a particular threat, displays a list of potentially infected clients, and links to the Client Detail page. The trend graph at the top of the report shows monitored and blocked transactions for a threat during the specified time range. The table at the bottom shows the actual number of monitored and blocked transactions for a threat during the specified time range.

- 
- Step 1** Navigate to the **Reporting > Anti-Malware** page.
- Step 2** In the Malware Threat table, click on a category in the Malware Category column.
-

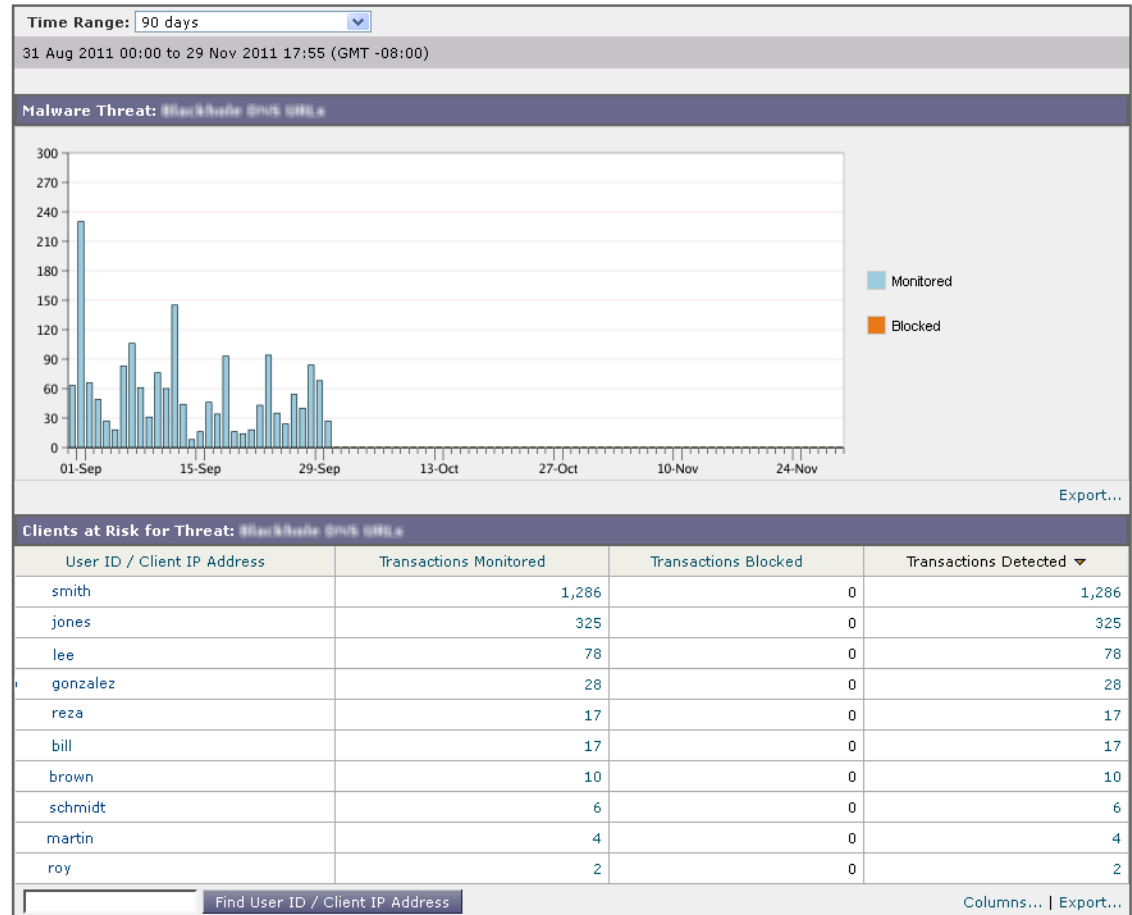

Figure 23-8 Malware Threats Report Page

## Malware Threat

Printable (PDF)

Adware &gt; Blackhole DNS URLs



## Client Malware Risk Page

The **Reporting > Client Malware Risk** page is a security-related reporting page that can be used to monitor client malware risk activity.

From the Client Malware Risk page, a system administrator can see which of their users are encountering the most blocks or warnings. Given the information gathered from this page, the administrator can click on the user link to view what this user doing on the web that makes them run into so many blocks or warnings and setting off more detections than the rest of the users on the network.

Additionally, the Client Malware Risk page lists client IP addresses involved in frequent malware connections, as identified by the L4 Traffic Monitor (L4TM). A computer that connects frequently to malware sites may be infected with malware that is trying to connect to a central command and control server and should be disinfected.

Figure 23-9 shows the Client Malware Risk page.

**Figure 23-9 Client Malware Risk Page**  
**Client Malware Risk**

Printable (PDF)

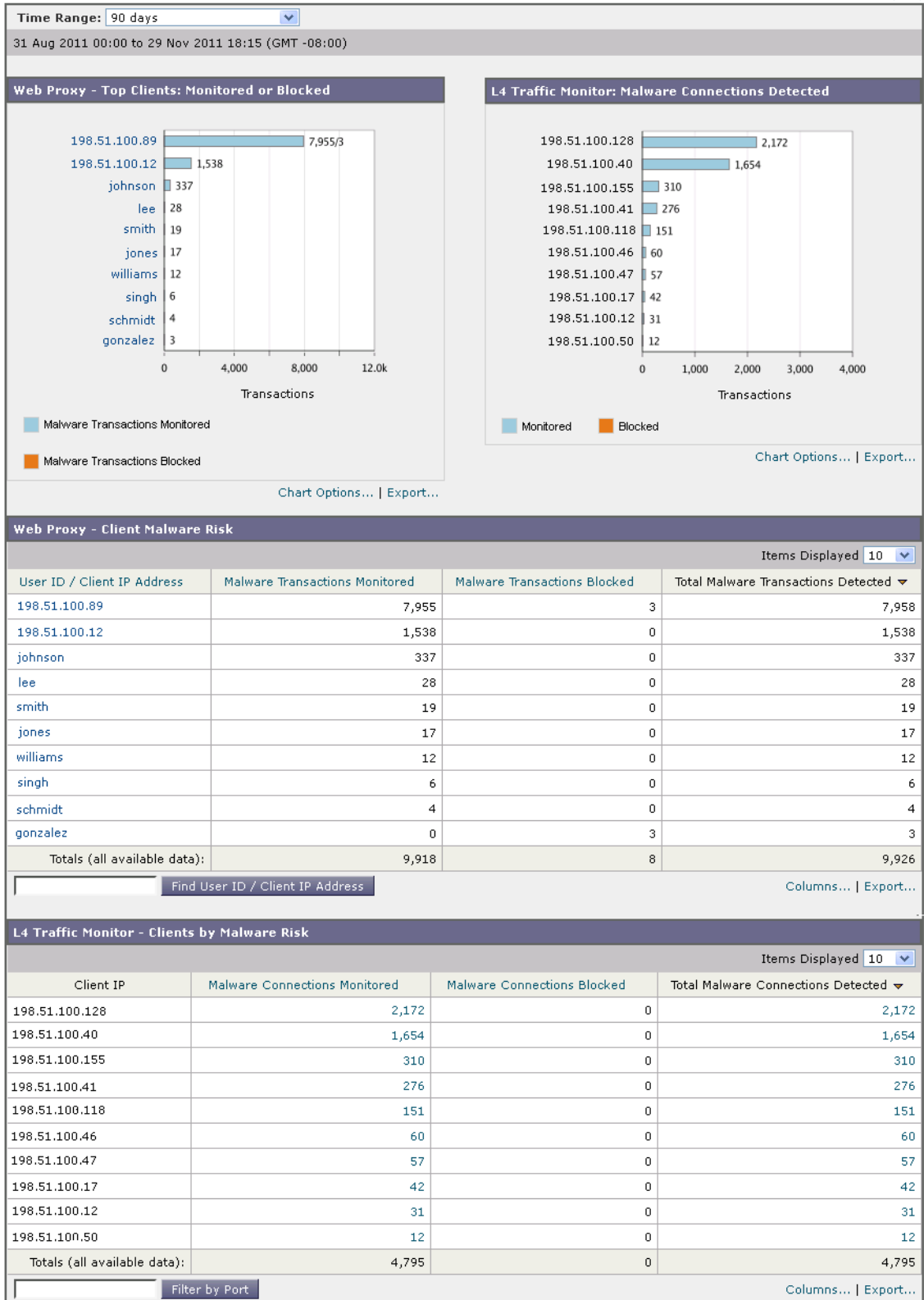

Table 23-8 describes the information on the Client Malware Risk page.

**Table 23-8 Client Malware Risk Report Page Components**

Section	Description
<b>Time Range (drop-down list)</b>	A menu that allows you to choose the time range of the data contained in the report. For more information, see the <a href="#">“Changing the Time Range”</a> section on page 22-2.
<b>Web Proxy: Top Clients by Malware Risk</b>	This chart displays the top ten users that have encountered a malware risk.
<b>L4 Traffic Monitor: Malware Connections Detected</b>	This chart displays the IP addresses of the computers in your organization that most frequently connect to malware sites.  This chart is the same as the “Top Client IPs” chart on the <a href="#">L4 Traffic Monitor Page, page 23-24</a> . See that section for more information and chart options.
<b>Web Proxy: Clients by Malware Risk</b>	The Web Proxy: Clients by Malware Risk table shows detailed information about particular clients that are displayed in the Web Proxy: Top Clients by Malware Risk section.  You can click each user in this table to open the <a href="#">Client Detail Page for Web Proxy - Clients by Malware Risk</a> that provides detailed information for each user. For more information, see the <a href="#">“Client Detail Page for Web Proxy - Clients by Malware Risk”</a> section on page 23-21.  Clicking on any of the links in the table allows you to view more granular details about individual users and what activity they are performing that is triggering the malware risk. For example, clicking on the link in the “User ID / Client IP Address” column takes you to a User page for that user.
<b>L4 Traffic Monitor: Clients by Malware Risk</b>	This table displays IP addresses of computers in your organization that frequently connect to malware sites.  This table is the same as the “Client Source IPs” table on the <a href="#">L4 Traffic Monitor Page, page 23-24</a> . For information about working with this table, see that section.

## Client Detail Page for Web Proxy - Clients by Malware Risk

The Client Details page shows all the web activity and malware risk data for a particular client during the specified time range, for entries in the Web Proxy - Client Malware Risk table on the Client Malware Risk page.

- 
- Step 1** Navigate to the **Reporting > Client Malware Risk** page.
- Step 2** In the **Web Proxy - Client Malware Risk** section, click on a user in the “User ID / Client IP Address” column.

For information about the items on this page, see [User Details Page, page 23-6](#)

---

# Web Reputation Filters Page

The **Reporting > Web Reputation Filters** page is a security-related reporting page that allows you to view the results of your set Web Reputation Filters for transactions during a specified time range.

[Figure 23-10](#) shows the Web Reputation Filters page.

Figure 23-10 Web Reputation Filters Page

Web Reputation Filters

Printable (PDF)

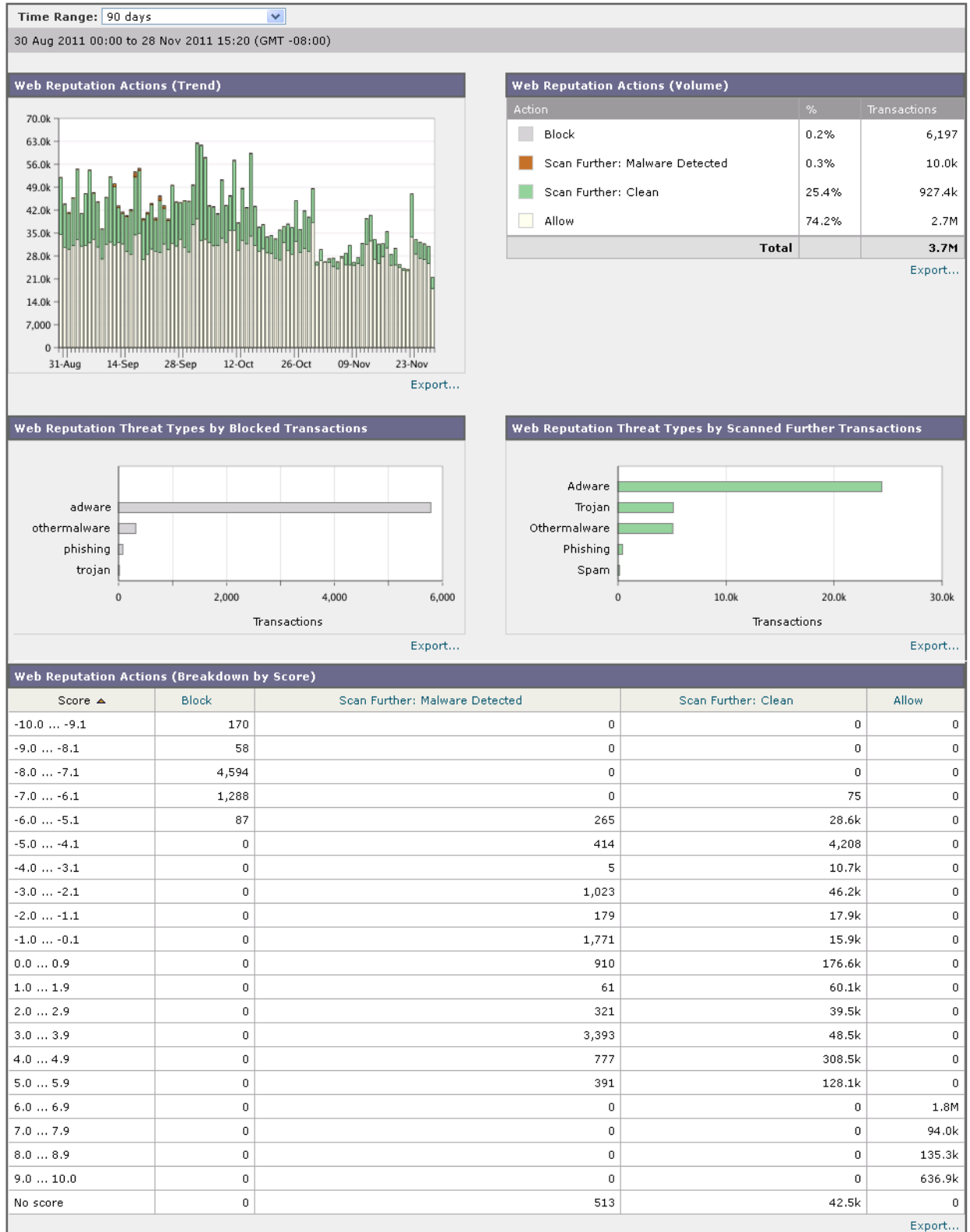

Table 23-9 describes the information on the Web Reputation Filters page.

**Table 23-9 Web Reputation Filters Report Page Components**

Section	Description
<b>Time Range (drop-down list)</b>	A menu that allows to choose the time range of the data contained in the report. For more information, see the “ <a href="#">Changing the Time Range</a> ” section on page 22-2.
<b>Web Reputation Actions (Trend)</b>	This section, in graph format, displays the total number of web reputation actions (vertical) against the time specified (horizontal timeline). From this you can see potential trends over time for web reputation actions.
<b>Web Reputation Actions (Volume)</b>	This section displays the web reputation action volume in percentages by transactions.
<b>Web Reputation Threat Types by Blocked Transactions</b>	This section displays the threat types that were blocked due to a low reputation score.
<b>Web Reputation Threat Types by Scanned Further Transactions</b>	This section displays the threat types that resulted in a reputation score that indicated to scan the transaction. It shows both monitored and blocked transactions.
<b>Web Reputation Actions (Breakdown by Score)</b>	This interactive table displays the web reputation scores broken down for each action.

## L4 Traffic Monitor Page

The **Reporting > L4 Traffic Monitor** page is a security-related reporting page that displays information about malware ports and malware sites that the L4 Traffic Monitor has detected during the specified time range. It also displays IP addresses of clients that frequently encounter malware sites.

The L4 Traffic Monitor listens to network traffic that comes in over all ports on the appliance and matches domain names and IP addresses against entries in its own database tables to determine whether to allow incoming and outgoing traffic.

You can use data in this report to determine whether to block a port or a site, or to investigate why a particular client IP address is connecting unusually frequently to a malware site (for example, this could be because the computer associated with that IP address is infected with malware that is trying to connect to a central command and control server.)

Figure 23-11 shows the L4 Traffic Monitor page.

Figure 23-11 L4 Traffic Monitor Page

L4 Traffic Monitor

Printable (PDF)

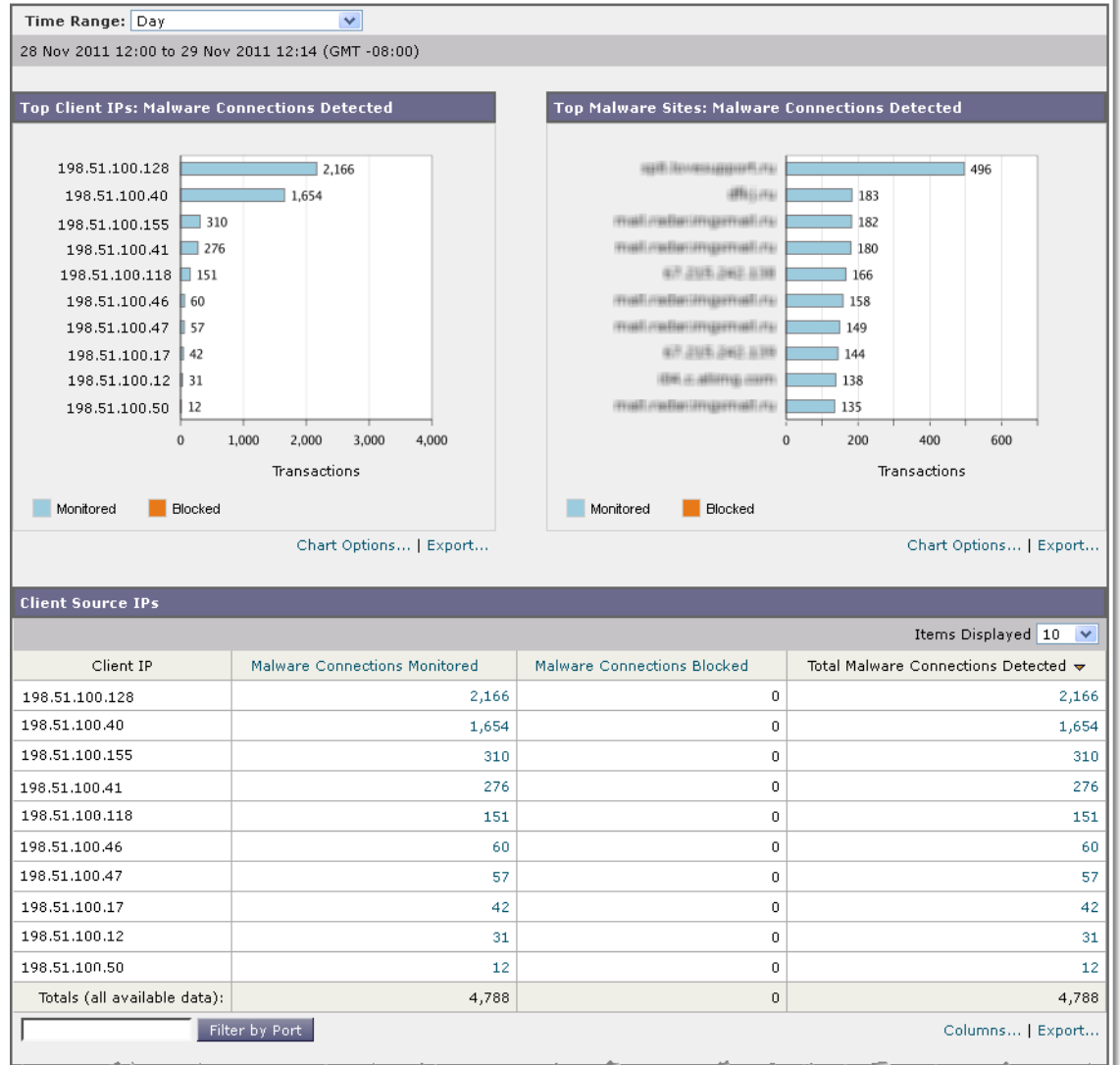

(Illustration continues on next page.)

(Illustration continued from previous page.)

Malware Ports			
Port	Malware Connections Monitored	Malware Connections Blocked	Total Malware Connections Detected ▼
80	4,383	0	4,383
6881	309	0	309
53	73	0	73
443	10	0	10
82	4	0	4
8080	4	0	4
3219	2	0	2
25	1	0	1
9548	1	0	1
35892	1	0	1
Totals (all available data):	4,788	0	4,788

Columns... | Export...

Malware Sites Detected				
				Items Displayed 10 ▼
Destination IP	Website	Malware Connections Monitored	Malware Connections Blocked	Total Malware Connections Detected ▼
129.249.237.25	apple.com/support.ru	496	0	496
96.226.4.239	fbj.ru	183	0	183
207.46.226.239	mail.nadlerimgmail.ru	182	0	182
207.46.226.239	mail.nadlerimgmail.ru	180	0	180
67.248.262.239	-	166	0	166
207.46.226.239	mail.nadlerimgmail.ru	158	0	158
207.46.226.239	mail.nadlerimgmail.ru	149	0	149
67.248.262.239	-	144	0	144
66.86.236.32	the-calling.com	138	0	138
207.46.226.239	mail.nadlerimgmail.ru	135	0	135
Totals (all available data):	--	4,788	0	4,788

Columns... | Export...

Filter by Port

Table 23-10 describes the information on the L4 Traffic Monitor page.

**Table 23-10 L4 Traffic Monitor Report Page Components**

Section	Description
<b>Time Range (drop-down list)</b>	A menu that allows you to choose a time range on which to report. For more information, see the <a href="#">“Changing the Time Range” section on page 22-2</a> .
<b>Top Client IPs</b>	<p>This section displays, in graph format, the IP addresses of computers in your organization that most frequently connect to malware sites.</p> <p>Click the Chart Options link below the chart to change the display from total Malware Connections Detected to Malware Connections Monitored or Malware Connections Blocked.</p> <p>This chart is the same as the “L4 Traffic Monitor: Malware Connections Detected” chart on the <a href="#">Client Malware Risk Page, page 23-19</a>.</p>



**Table 23-10 L4 Traffic Monitor Report Page Components (continued)**

Section	Description
<b>Top Malware Sites</b>	<p>This section displays, in graph format, the top malware domains detected by the L4 Traffic Monitor.</p> <p>Click the Chart Options link below the chart to change the display from total Malware Connections Detected to Malware Connections Monitored or Malware Connections Blocked.</p>
<b>Client Source IPs</b>	<p>This table displays the IP addresses of computers in your organization that frequently connect to malware sites.</p> <p>To include only data for a particular port, enter a port number into the box at the bottom of the table and click Filter by Port. You can use this feature to help determine which ports are used by malware that “calls home” to malware sites.</p> <p>To view details such as the port and destination domain of each connection, click an entry in the table. For example, if one particular client IP address has a high number of Malware Connections Blocked, click the number in that column to view a list of each blocked connection. The list is displayed as search results in the L4 Traffic Monitor tab on the Reporting &gt; Web Tracking page. For more information about this list, see <a href="#">Searching for Transactions Processed by the L4 Traffic Monitor, page 23-35</a>.</p> <p>This table is the same as the “L4 Traffic Monitor - Clients by Malware Risk” table on the <a href="#">Client Malware Risk Page, page 23-19</a>.</p>
<b>Malware Ports</b>	<p>This table displays the ports on which the L4 Traffic Monitor has most frequently detected malware.</p> <p>To view details, click an entry in the table. For example, click the number of Total Malware Connections Detected to view details of each connection on that port. The list is displayed as search results in the L4 Traffic Monitor tab on the Reporting &gt; Web Tracking page. For more information about this list, see <a href="#">Searching for Transactions Processed by the L4 Traffic Monitor, page 23-35</a>.</p>
<b>Malware Sites Detected</b>	<p>This table displays the domains on which the L4 Traffic Monitor most frequently detects malware.</p> <p>To include only data for a particular port, enter a port number into the box at the bottom of the table and click Filter by Port. You can use this feature to help determine whether to block a site or a port.</p> <p>To view details, click an entry in the table. For example, click the number of Malware Connections Blocked to view the list of each blocked connection for a particular site. The list is displayed as search results in the L4 Traffic Monitor tab on the Reporting &gt; Web Tracking page. For more information about this list, see <a href="#">Searching for Transactions Processed by the L4 Traffic Monitor, page 23-35</a>.</p>

# SOCKS Proxy Page

The **Reporting > SOCKS Proxy** Page allows you to view data and trends for transactions processed through the SOCKS proxy, including information about top destinations and users.

To change SOCKS policy settings, see [Chapter 6, “SOCKS Proxy Services.”](#)

SOCKS Proxy

Printable (PDF)

Time Range: Day  
 31 Oct 2012 15:00 to 01 Nov 2012 15:56 (GMT -07:00)

**Top Destinations for SOCKS: Total Transactions**

Destination	Transactions
cisco24.com:29	9
cisco5.com:29	8
cisco1.com:13	7
cisco10.com:14	7
cisco13.com:18	7
cisco14.com:28	7
cisco21.com:38	7
cisco6.com:18	7
cisco1.com:18	6
cisco12.com:19	6

Chart Options... | Export...

**Top Users for SOCKS: Total Transactions**

User	Transactions
user5	36
user14	35
user17	35
user24	33
user23	32
user9	29
user12	28
user20	28
user13	26
user16	26

Chart Options... | Export...

**Destinations** Items Displayed 10

Domain/IP:Port	TCP / UDP	Bandwidth Used	Transactions Allowed	Transactions Blocked	Total Transactions
cisco1.com:3	TCP	120B	4	0	4
cisco1.com:9	TCP	360B	4	0	4
cisco1.com:13	TCP	910B	7	0	7
cisco1.com:14	UDP	420B	3	0	3
cisco1.com:18	UDP	1,080B	6	0	6
cisco1.com:19	TCP	570B	3	0	3
cisco1.com:23	TCP	230B	1	0	1
cisco1.com:24	UDP	960B	4	0	4
cisco10.com:13	UDP	130B	1	0	1
cisco10.com:14	TCP	980B	7	0	7
Totals (all available data):	--	162.0KB	627	0	627

Find Domain/IP Columns... | Export...

**Users** Items Displayed 10

User ID or Client IP	Bandwidth Used	Transactions Allowed	Transactions Blocked	Total Transactions
user10	4,150B	17	0	17
user11	5,040B	20	0	20
user12	5,690B	28	0	28
user13	6,990B	26	0	26
user14	10,050B	35	0	35
user15	3,800B	13	0	13
user16	7,990B	26	0	26
user17	10,110B	35	0	35
user18	7,440B	25	0	25
user19	8,240B	24	0	24
Totals (all available data):	162.0KB	627	0	627

Find User ID or Client IP Columns... | Export...

**Related Topics**

- [Configuring the SOCKS Proxy, page 6-2](#)

## Reports by User Location Page

The **Reporting > Reports by User Location** page allows you to find out what activities your local and remote users are conducting. For more information on remote and local users, see [Working with Remote Users, page 14-2](#).

Activities include:

- URL categories that are being accessed by the local and remote users.
- Anti-Malware activity that is being triggered by sites the local and remote users are accessing.
- Web Reputation of the sites being accessed by the local and remote users.
- Applications that are being accessed by the local and remote users.
- Users (local and remote).
- Domains accessed by local and remote users.

[Figure 23-12](#) shows the Reports by User Location page.

Figure 23-12 Reports by User Location Page

### Reports by User Location

[ Summary | URL Category | Anti-Malware | Web Reputation | Applications | Users | Domains | SOCKS ]

[Printable \(PDF\)](#)

**Time Range:** 90 days ▼

30 Aug 2011 00:00 to 28 Nov 2011 15:41 (GMT -08:00)

**Total Web Proxy Activity - Remote Users**

*No data was found in the selected time range*

**Web Proxy Summary**

*No data was found in the selected time range*

**Total Web Proxy Activity - Local Users**

[Export...](#)

**Web Proxy Summary**

Web Proxy	%	Transactions
Clean	99.4%	3.6M
Suspect	0.6%	22.3k
<b>Total Transactions:</b>		<b>3.7M</b>

[Export...](#)

**Suspect Transactions Detected - Remote Users**

*No data was found in the selected time range*

**Suspect Transactions Summary**

*No data was found in the selected time range*

**Suspect Transactions Detected - Local Users**

[Export...](#)

**Suspect Transactions Summary**

	%	Transactions
Blocked or Warned by URL Category	6.3%	1,416
Blocked by Application	0.0%	2
Blocked by Web Reputation Filters	27.7%	6,197
Transactions Detected by Anti-Malware	44.9%	10.0k
Other Blocked Transactions	18.1%	4,034
<b>Total Transactions:</b>		<b>22.3k</b>

[Export...](#)

Table 23-11 describes the information on the Reports by User Location page.

**Table 23-11 Reports by User Location Report Page Components**

Section	Description
<b>Time Range (drop-down list)</b>	A menu that allows to choose the time range of the data contained in the report. For more information, see the <a href="#">“Changing the Time Range” section on page 22-2</a> .
<b>Total Web Proxy Activity: Remote Users</b>	This section displays, in graph format, the activity of your remote users (vertical) over the specified time (horizontal).
<b>Web Proxy Summary</b>	This section displays a summary of the activities of the local and remote users on the network.
<b>Total Web Proxy Activity: Local Users</b>	This section displays, in graph format, the activity of your remote users (vertical) over the specified time (horizontal).
<b>Suspect Transactions Detected: Remote Users</b>	This section displays, in graph format, the suspect transactions that have been detected due to Access Policies defined for remote users (vertical) over the specified time (horizontal).
<b>Suspect Transactions Summary</b>	This section displays a summary of suspected transactions of the remote users on the network.
<b>Suspect Transactions Detected: Local Users</b>	This section displays, in graph format, the suspect transactions that have been detected due to Access Policies defined for your remote users (vertical) over the specified time (horizontal).
<b>Suspect Transactions Summary</b>	This section displays a summary of suspected transactions of the local users on the network.

From the **Reports by User Location** page you can generate reports showing the activity of local and remote users. This allows you to easily compare local and remote activities of your users.

## Web Tracking Page

Use the Web Tracking page to search for and get details about individual transactions or patterns of transactions that may be of concern. Depending on your needs, search in one or both of the following tabs:

- [Searching for Transactions Processed by the Web Proxy, page 23-32](#)
- [Searching for Transactions Processed by the L4 Traffic Monitor, page 23-35](#)
- [Searching for Transactions Processed by the SOCKS Proxy, page 23-35](#)

## Searching for Transactions Processed by the Web Proxy

You can use the **Proxy Services** tab on the **Reporting > Web Tracking** page to track and report on web usage for a particular user or for all users. This tab aggregates web tracking information from individual security components as well as acceptable use enforcement components and records data that can be used to monitor your web traffic patterns and security risks.

The Proxy Services tab shows results for individual transactions and the results include the hostname and domain in the URL (such as mail.google.com) instead of just the domain name (such as google.com).

You might want to use it to assist the following roles:

- **HR or Legal manager.** Run an investigative report for an employee during a specific time period.
- **Network security administrator.** Examine whether the company network is being exposed to malware threats through employees' smartphones.

You can view search results for the type of transactions logged (blocked, monitored, warned, and completed) during a particular time period. You can also filter the data results using several criteria, such as URL category, malware threat, and application.

After you search for a set of transactions, you can choose which columns to display, and you can sort the data by a column. For more information, see the [“Working with Columns on Report Pages”](#) section on page 22-4.



**Note**

The Web Proxy only reports on transactions that include an ACL decision tag other than “OTHER-NONE.”

To search for instances of web activity that concern you:

**Step 1** Navigate to the **Reporting > Web Tracking** page.

**Step 2** Click the **Proxy Services** tab.

**Step 3** Configure the fields defined in [Table 23-12](#).

**Table 23-12 Basic Settings in the Proxy Services Tab on the Web Tracking Page**

Setting	Description
<b>Time Range</b>	Choose the time range on which to report. For more information, see the <a href="#">“Changing the Time Range”</a> section on page 22-2.
<b>User/Client IP</b>	Optionally, enter an authentication username as it appears in reports or a client IP address that you want to track. You can also enter an IP range in CIDR format, such as 172.16.0.0/16.  When you leave this field empty, the search returns results for all users.
<b>Website</b>	Optionally, enter a website that you want to track. When you leave this field empty, the search returns results for all websites.
<b>Transaction Type</b>	Choose the type of transactions that you want to track, either All Transactions, Completed, Blocked, Monitored, or Warned.

- Step 4** Optionally, expand the Advanced section and configure the fields defined in [Table 23-13](#) to filter the web tracking results with more advanced criteria.

**Table 23-13** *Advanced Settings in the Proxy Services tab on the Web Tracking Page*

Setting	Description
<b>URL Category</b>	To filter by a URL category, select <b>Filter by URL Category</b> and type the first letter of a URL category by which to filter. Choose the category from the list that appears.  If the set of URL categories has been updated, some categories may be labeled “Deprecated”. These categories are no longer being used for new transactions, but you can use them to search for transactions that occurred before the category set update. For more information about updates to the URL Category set, see <a href="#">URL Category Set Updates and Reports, page 23-12</a> .
<b>Application</b>	To filter by an application, select <b>Filter by Application</b> and choose an application by which to filter.  To filter by an application type, select <b>Filter by Application Type</b> and choose an application type by which to filter.
<b>Policy</b>	To filter by a policy group, select <b>Filter by Policy</b> and enter a policy group name by which to filter.
<b>Malware Threat</b>	To filter by a particular malware threat, select <b>Filter by Malware Threat</b> and enter a malware threat name by which to filter.  To filter by a malware category, select <b>Filter by Malware Category</b> and choose a malware category by which to filter.
<b>WBRS</b>	In the WBRS section, you can filter by web reputation score and by a particular web reputation threat. <ul style="list-style-type: none"> <li>To filter by web reputation score, select <b>Score Range</b> and select the upper and lower values by which to filter. Or, you can filter for websites that have no score by selecting <b>No Score</b>.</li> <li>To filter by web reputation threat, select <b>Filter by Reputation Threat</b> and enter a web reputation threat by which to filter.</li> </ul>
<b>AnyConnect Secure Mobility</b>	To filter by the location of users (either remote or local), select <b>Filter by User Location</b> and choose a user type by which to filter.
<b>User Request</b>	To filter by transactions that were initiated by the client, select <b>Filter by User-Requested Transactions</b> .  <b>Note:</b> When you enable this filter, the search results include some “best guess” transactions.

- Step 5** Click **Search**.

Results are sorted by time stamp, with the most recent result at the top.

The number in parentheses below the “Display Details” link is the number of related transactions spawned by the user-initiated transaction, such as images loaded, javascripts run, and secondary sites accessed.

- Step 6** Optionally, click **Display Details** in the Transactions column to view more detailed information about each transaction.





---

**Note** If you need to view more than 1000 results, click the **Printable Download** link to obtain a CSV file that includes the complete set of raw data, excluding details of related transactions.

---



---

**Tip** If a URL in the results is truncated, you can find the full URL in the access log.

---

To view details for up to 500 related transactions, click the **Related Transactions** link.

---

## Searching for Transactions Processed by the L4 Traffic Monitor

The L4 Traffic Monitor tab on the **Reporting > Web Tracking** page provides details about connections to malware sites and ports. You can search for connections to malware sites by the following types of information:

- Time range
- Site, using IP address or domain
- Port
- IP address associated with a computer in your organization
- Connection type

The first 1000 matching search results are displayed.

To view the hostname at the questionable site, click the Display Details link in the Destination IP Address column heading.

## Searching for Transactions Processed by the SOCKS Proxy

You can search for transactions that meet a variety of criteria, including blocked or completed transactions; users; and destination domain, IP address, or port. You can also filter results by custom URL category, policy matched, and user location (local or remote).

- 
- Step 1** Choose **Web > Reporting > Web Tracking**.
- Step 2** Click the **SOCKS Proxy** tab.
- Step 3** To filter results, click **Advanced**.
- Step 4** Enter search criteria.
- Step 5** Click **Search**.
- 

### Related Topics

- [SOCKS Proxy Page, page 23-28](#)

# System Capacity Page

The **Reporting > System Capacity** page displays current and historical information about resource usage on the Web Security appliance.

You might want to use the System Capacity report to accomplish any of the following tasks:

- Learn when the Web Security appliance is exceeding the recommended capacity to help determine when to upgrade or obtain additional appliances.
- Identify historical trends in system behavior which point to upcoming capacity issues which require planning.
- Identify which part of the system is using the most resources to assist with troubleshooting.

Figure 23-13 shows the first four graphs on the **System Capacity** page.

**Figure 23-13** System Capacity Page—Upper Graphs

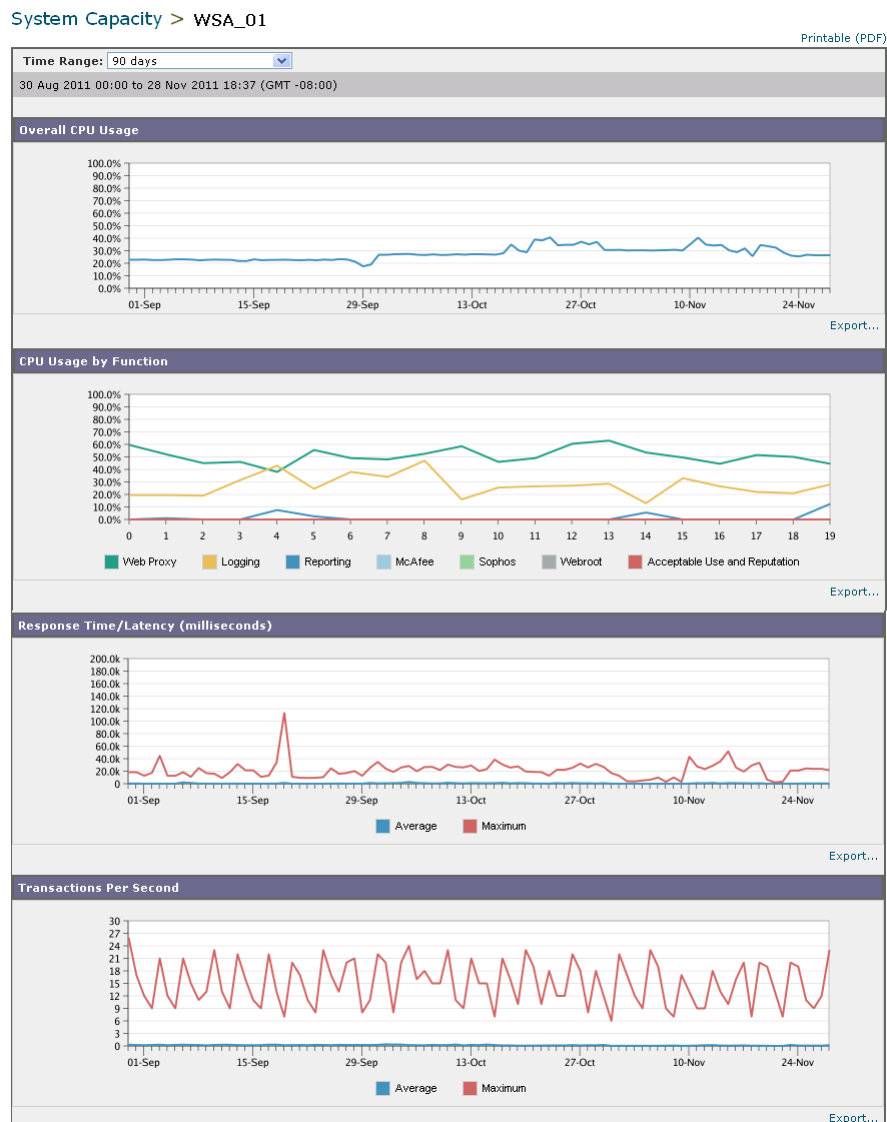
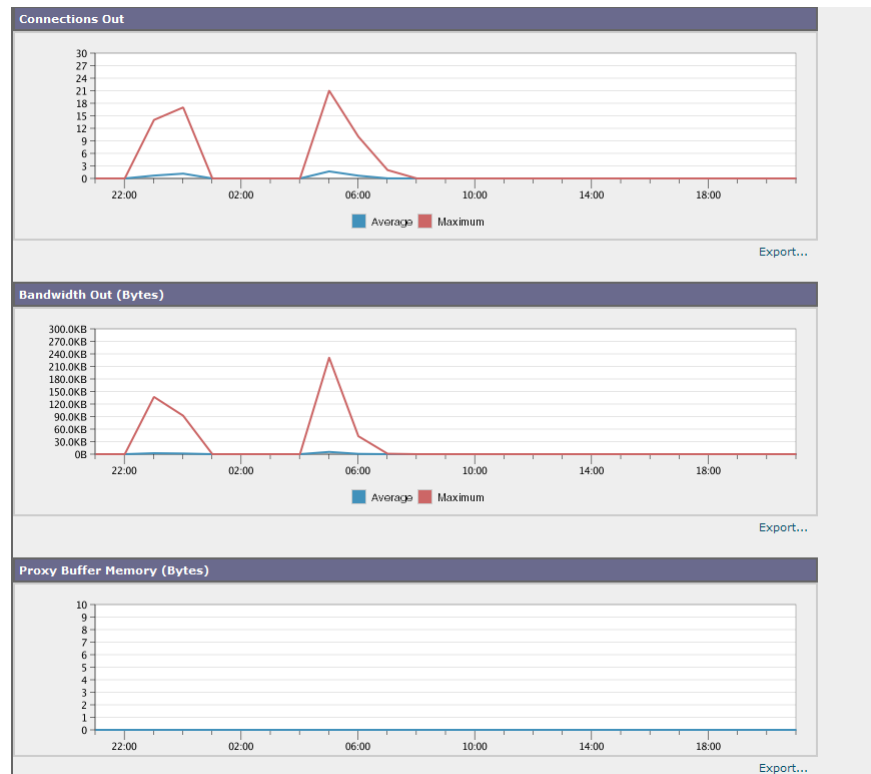

Figure 23-14 shows the last three graphs on the **System Capacity** page.

**Figure 23-14** System Capacity Page—Lower Graphs



The System Capacity report includes graphs that show the overall CPU usage on the appliance. AsyncOS for Web is optimized to use idle CPU resources to improve transaction throughput. High CPU usage may not indicate a system capacity problem. The **CPU Usage by Function** graph that displays the percentage of CPU cycles used by different functions, such as the Web Proxy and Logging. The **CPU Usage by Function** graph can indicate which appliance components use the most resources. If you need to optimize your appliance, this graph can help you determine which functions may need to be tuned.

The Response Time/Latency and Transactions Per Second graphs shows the overall response time (in milliseconds), and transactions per second for the date range specified in the Time Range drop-down menu.

The lower three graphs on the System Capacity report show the outgoing connections, the bandwidth the appliance uses connecting out to upstream servers, and the size of the Web Proxy memory buffer.

The Proxy Buffer Memory may indicate spikes in network traffic, but if the graph climbs steadily to the maximum, the appliance may be reaching its maximum capacity and you should consider adding capacity.

## Interpreting the Data You See on System Capacity Page

When choosing time ranges for viewing data on the System Capacity page, the following is important to remember:

- **Hour Report.** The Hour report queries the minute table and displays the exact number of items, such as bytes and connection, that have been recorded by the appliance on an minute by minute basis over a 60 minute period. This information is gathered from the hour table.
- **Day Report.** The Day report queries the hour table and displays the exact number of items, such as bytes and connection, that have been recorded by the appliance on an hourly basis over a 24 hour period. This information is gathered from the hour table.

The Week Report and 30 Days Report work similarly to the Hour and Day Reports.

The “Maximum” value indicator on the System Capacity page is the highest value seen for the specified period. The “Average” value is the average of all values for the specified period. The period of aggregation depends on the interval selected for that report. For example, you can choose to see the Average and Maximum values for each day if the chart is for a month period.

## System Status Page

Use the **Reporting > System Status** page to monitor the System Status. This page displays the current status and configuration of the Web Security appliance. [Table 23-14](#) describes each section.

**Table 23-14** System Status Report Page Components

This Section...	Displays
Web Security Appliance Status	<ul style="list-style-type: none"> <li>• System uptime</li> <li>• System resource utilization — CPU usage, RAM usage, and percentage of disk space used for reporting and logging.</li> </ul> <p>RAM usage for a system that is working efficiently may be above 90%, because RAM that is not otherwise in use by the system is used by the web object cache. If your system is not experiencing serious performance issues and this value is not stuck at 100%, the system is operating normally.</p> <p><b>Note</b> Proxy Buffer Memory is one component that uses this RAM. For more information about this, see the <a href="#">System Capacity Page, page 23-36</a>.</p>

**Table 23-14** System Status Report Page Components (continued)

This Section...	Displays
Proxy Traffic Characteristics	<ul style="list-style-type: none"> <li>• Transactions per second</li> <li>• Bandwidth</li> <li>• Response time</li> <li>• Cache hit rate</li> <li>• Connections</li> </ul>
Current Configuration	<p>Web Proxy settings:</p> <ul style="list-style-type: none"> <li>• Web Proxy Status — enabled or disabled.</li> <li>• Deployment Topology.</li> <li>• Web Proxy Mode — forward or transparent.</li> <li>• IP Spoofing — enabled or disabled.</li> </ul> <p>L4 Traffic Monitor settings:</p> <ul style="list-style-type: none"> <li>• L4 Traffic Monitor Status — enabled or disabled.</li> <li>• L4 Traffic Monitor Wiring.</li> <li>• L4 Traffic Monitor Action — monitor or block.</li> </ul> <p>Web Security Appliance Version Information</p> <p>Hardware information</p>



# 24

## Logging

---

- [Logging Overview, page 24-1](#)
- [Working with Log Subscriptions, page 24-7](#)
- [Access Log File, page 24-14](#)
- [W3C Compliant Access Logs, page 24-26](#)
- [Custom Formatting in Access Logs and W3C Logs, page 24-28](#)
- [Including HTTP/HTTPS Headers in Log Files, page 24-37](#)
- [Malware Scanning Verdict Values, page 24-38](#)
- [Traffic Monitor Log, page 24-39](#)
- [Troubleshooting, page 24-39](#)

## Logging Overview

You can use log files to monitor web traffic. To configure the appliance to create log files, you create log subscriptions. A log subscription is an appliance configuration that associates a log file type with a name, logging level, and other parameters, such as size and destination information. You can subscribe to a variety of log file types. For more information about log subscriptions, see [Working with Log Subscriptions, page 24-7](#).

In typical appliance monitoring, the appliance administrator usually reads the following log files:

- **Access log.** Records all Web Proxy filtering and scanning activity. For more information about the access log, see [Access Log File, page 24-14](#).
- **Traffic Monitor log.** Records all L4 Traffic Monitor activity. For more information about the traffic monitor log, see [Traffic Monitor Log, page 24-39](#).

The appliance also creates other log file types, such as the system log file. You might want to read other log files to troubleshoot appliance errors. For a list of each type, see [Log File Types, page 24-1](#).

The appliance provides several options for customizing the type of information recorded in the access log. For more information, see [Custom Formatting in Access Logs and W3C Logs, page 24-28](#).

## Log File Types

The log file type indicates what information is recorded in the generated log, such as web traffic or system data. By default, the Web Security appliance has log subscriptions for most log file types already created. However, there are some log file types that specific to troubleshooting the Web Proxy. Those logs are not created by default. For more information on those log file types, see [Web Proxy Logging, page 24-6](#).

Table 24-1 lists the Web Security appliance log file types created by default.

**Table 24-1** Default Log File Types

Log File Type	Description	Supports Syslog Push?	Enabled by Default?
Access Control Engine Logs	Records messages related to the Web Proxy ACL (access control list) evaluation engine.	No	No
Access Logs	Records Web Proxy client history.	Yes	Yes
Authentication Framework Logs	Records authentication history and messages.	No	Yes
AVC Engine Framework Logs	Records messages related to communication between the Web Proxy and the AVC engine.	No	No
AVC Engine Logs	Records debug messages from the AVC engine.	Yes	Yes
CLI Audit Logs	Records a historical audit of command line interface activity.	Yes	Yes
Configuration Logs	Records messages related to the Web Proxy configuration management system.	No	No
Connection Management Logs	Records messages related to the Web Proxy connection management system.	No	No
Data Security Logs	Records client history for upload requests that are evaluated by the Cisco IronPort Data Security Filters.  For more information on the data security log, see <a href="#">Logging, page 13-17</a> .	Yes	Yes
Data Security Module Logs	Records messages related to the Cisco IronPort Data Security Filters.	No	No
DCA Engine Framework Logs (Dynamic Content Analysis)	Records messages related to communication between the Web Proxy and the Cisco IronPort Web Usage Controls Dynamic Content Analysis engine.	No	No
DCA Engine Logs (Dynamic Content Analysis)	Records messages related to the Cisco IronPort Web Usage Controls Dynamic Content Analysis engine.	Yes	Yes
Default Proxy Logs	Records errors related to the Web Proxy.  This is the most basic of all Web Proxy related logs. To troubleshoot more specific aspects related to the Web Proxy, create a log subscription for the applicable Web Proxy module.  For more information about Web Proxy logging, see <a href="#">Web Proxy Logging, page 24-6</a> .	Yes	Yes
Disk Manager Logs	Records Web Proxy messages related to writing to the cache on disk.	No	No



**Table 24-1** Default Log File Types (continued)

Log File Type	Description	Supports Syslog Push?	Enabled by Default?
External Authentication Logs	Records messages related to using the external authentication feature, such as communication success or failure with the external authentication server.  Even with external authentication is disabled, this log contains messages about local users successfully or failing logging in.  For more information on external authentication, see <a href="#">RADIUS User Authentication, page 26-12</a> .	No	Yes
Feedback Logs	Records the web users reporting misclassified pages.	Yes	Yes
FTP Proxy Logs	Records error and warning messages related to the FTP Proxy.	No	No
FTP Server Logs	Records all files uploaded to and downloaded from the Web Security appliance using FTP.	Yes	Yes
GUI Logs (Graphical User Interface)	Records history of page refreshes in the web interface. GUI logs also include information about SMTP transactions, for example information about scheduled reports emailed from the appliance.	Yes	Yes
Haystack Logs	Haystack logs record web transaction tracking data processing.	Yes	Yes
HTTPS Logs	Records Web Proxy messages specific to the HTTPS Proxy (when the HTTPS Proxy is enabled).	No	No
License Module Logs	Records messages related to the Web Proxy's license and feature key handling system.	No	No
Logging Framework Logs	Records messages related to the Web Proxy's logging system.	No	No
Logging Logs	Records errors related to log management.	Yes	Yes
McAfee Integration Framework Logs	Records messages related to communication between the Web Proxy and the McAfee scanning engine.	No	No
McAfee Logs	Records the status of anti-malware scanning activity from the McAfee scanning engine.	Yes	Yes
Memory Manager Logs	Records Web Proxy messages related to managing all memory including the in-memory cache for the Web Proxy process.	No	No
Miscellaneous Proxy Modules Logs	Records Web Proxy messages that are mostly used by developers or customer support.	No	No
AnyConnect Secure Mobility Daemon Logs	Records the interaction between the Web Security appliance and the AnyConnect client, including the status check.	Yes	Yes

Table 24-1 Default Log File Types (continued)

Log File Type	Description	Supports Syslog Push?	Enabled by Default?
NTP Logs (Network Time Protocol)	Records changes to the system time made by the Network Time Protocol.	Yes	Yes
PAC File Hosting Daemon Logs	Records proxy auto-config (PAC) file usage by clients.	Yes	Yes
Proxy Bypass Logs	Records transactions that bypass the Web Proxy.	No	Yes
Reporting Logs	Records a history of report generation.	Yes	Yes
Reporting Query Logs	Records errors related to report generation.	Yes	Yes
Request Debug Logs	Records very detailed debug information on a specific HTTP transaction from all Web Proxy module log types. You might want to create this log subscription to troubleshoot a proxy issue with a particular transaction without creating all other proxy log subscriptions.  <b>Note:</b> You can create this log subscription in the CLI only.	No	No
SaaS Auth Logs	Records messages related to the SaaS Access Control feature.	Yes	Yes
SHD Logs (System Health Daemon)	Records a history of the health of system services and a history of unexpected daemon restarts.	Yes	Yes
SNMP Logs	Records debug messages related to the SNMP network management engine.	Yes	Yes
SNMP Module Logs	Records Web Proxy messages related to interacting with the SNMP monitoring system.	No	No
Sophos Integration Framework Logs	Records messages related to communication between the Web Proxy and the Sophos scanning engine.	No	No
Sophos Logs	Records the status of anti-malware scanning activity from the Sophos scanning engine.	Yes	Yes
Status Logs	Records information related to the system, such as feature key downloads.	Yes	Yes
System Logs	Records DNS, error, and commit activity.	Yes	Yes
Traffic Monitor Error Logs	Records L4TM interface and capture errors.	Yes	Yes
Traffic Monitor Logs	Records sites added to the L4TM block and allow lists.	No	Yes

**Table 24-1** Default Log File Types (continued)

Log File Type	Description	Supports Syslog Push?	Enabled by Default?
UDS Logs (User Discovery Service)	Records data about how the Web Proxy discovers the user name without doing actual authentication. It includes information about interacting with the Cisco adaptive security appliance for the Secure Mobility as well as integrating with the Novell eDirectory server for transparent user identification.  For more information, see <a href="#">Achieving Secure Mobility Overview, page 14-1</a> and <a href="#">Identifying Users Transparently, page 8-12</a> .	Yes	Yes
Updater Logs	Records a history of WBRS and other updates.	Yes	Yes
W3C Logs	Records Web Proxy client history in a W3C compliant format.  For more information, see <a href="#">W3C Compliant Access Logs, page 24-26</a> .	Yes	No
WBNP Logs (SensorBase Network Participation)	Records a history of Cisco SensorBase Network participation uploads to the SensorBase network.	No	Yes
WBRS Framework Logs (Web Reputation Score)	Records messages related to communication between the Web Proxy and the Web Reputation Filters.	No	No
WCCP Module Logs	Records Web Proxy messages related to implementing WCCP.	No	No
Webcat Integration Framework Logs	Records messages related to communication between the Web Proxy and the URL filtering engine associated with Cisco IronPort Web Usage Controls.	No	No
WebrootIntegration Framework Logs	Records messages related to communication between the Web Proxy and the Webroot scanning engine.	No	No
Webroot Logs	Records the status of anti-malware scanning activity from the Webroot scanning engine.	Yes	Yes
Welcome Page Acknowledgement Logs	Records a history of web clients who click the Accept button on the end-user acknowledgement page.	Yes	Yes

## Web Proxy Logging

By default, the Web Security appliance has one log subscription created for Web Proxy logging messages, the “Default Proxy Logs.” The Web Proxy information stored in this log covers all aspects, or modules, of the Web Proxy. The appliance also includes log file types for each Web Proxy module so you can read more specific debug information for each module without cluttering up the Default Proxy Logs.

If a user or administrator encounters an issue with the Web Proxy behavior, read the Default Proxy Logs first. If you see a log entry that you suspect might be the symptom of an issue, then you can create a log subscription for the relevant specific Web Proxy module. Then read that proxy log to help troubleshoot the problem.

You can create log subscriptions of these proxy module logs in web interface or in the CLI. However, you can only create the Request Debug Logs in the CLI.

The following list includes all Web Proxy module log types:

- Access Control Engine Logs
- AVC Engine Framework Logs
- Configuration Logs
- Connection Management Logs
- Data Security Module Logs
- DCA Engine Framework Logs
- Disk Manager Logs
- FTP Proxy Logs
- HTTPS Logs
- License Module Logs
- Logging Framework Logs
- McAfee Integration Framework Logs
- Memory Manager Logs
- Miscellaneous Proxy Modules Logs
- Request Debug Logs
- SNMP Module Logs
- Sophos Integration Framework Logs
- WBRs Framework Logs
- WCCP Module Logs
- Webcat Integration Framework Logs
- Webroot Integration Framework Logs

For a description of each log type, see Table 24-1, ‘Default Log File Types,’ on page 2.

# Working with Log Subscriptions

A log subscription is an appliance configuration that specifies the type of log file to create and other factors, such as the log file name and method of retrieving the log file. Use the System Administration > Log Subscriptions page to configure log file subscriptions.

Figure 24-1 shows the Log Subscriptions page where you work with log subscriptions.

**Figure 24-1** Log File Subscriptions

## Log Subscriptions

Configured Log Subscriptions				
Add Log Subscription...				
Log Name	Type	Log Files	All Rollover	Delete
accesslogs	Access Logs	ftp://esx16-wsa01.qa/accesslogs	<input type="checkbox"/>	
authlogs	Authentication Framework Logs	ftp://esx16-wsa01.qa/authlogs	<input type="checkbox"/>	
avc_logs	AVC Engine Logs	ftp://esx16-wsa01.qa/avc_logs	<input type="checkbox"/>	
bypasslogs	Proxy Bypass Logs	ftp://esx16-wsa01.qa/bypasslogs	<input type="checkbox"/>	
cli_logs	CLI Audit Logs	ftp://esx16-wsa01.qa/cli_logs	<input type="checkbox"/>	
dca_logs	DCA Engine Logs	ftp://esx16-wsa01.qa/dca_logs	<input type="checkbox"/>	
external_auth_logs	External Authentication Logs	ftp://esx16-wsa01.qa/external_auth_logs	<input type="checkbox"/>	
feedback_logs	Feedback Logs	ftp://esx16-wsa01.qa/feedback_logs	<input type="checkbox"/>	
ftpd_logs	FTP Server Logs	ftp://esx16-wsa01.qa/ftpd_logs	<input type="checkbox"/>	
gui_logs	GUI Logs	ftp://esx16-wsa01.qa/gui_logs	<input type="checkbox"/>	
idsdataloss_logs	Data Security Logs	ftp://esx16-wsa01.qa/idsdataloss_logs	<input type="checkbox"/>	
logderrorlogs	Logging Logs	ftp://esx16-wsa01.qa/logderrorlogs	<input type="checkbox"/>	
mcafee_logs	McAfee Logs	ftp://esx16-wsa01.qa/mcafee_logs	<input type="checkbox"/>	
musd_logs	Mobile User Security Daemon Logs	ftp://esx16-wsa01.qa/musd_logs	<input type="checkbox"/>	
pacd_logs	PAC File Hosting Daemon Logs	ftp://esx16-wsa01.qa/pacd_logs	<input type="checkbox"/>	
proxylogs	Default Proxy Logs	ftp://esx16-wsa01.qa/proxylogs	<input type="checkbox"/>	
reportd_logs	Reporting Logs	ftp://esx16-wsa01.qa/reportd_logs	<input type="checkbox"/>	
reportqueryd_logs	Reporting Query Logs	ftp://esx16-wsa01.qa/reportqueryd_logs	<input type="checkbox"/>	
saas_auth_log	SaaS Auth Logs	ftp://esx16-wsa01.qa/saas_auth_log	<input type="checkbox"/>	
shd_logs	SHD Logs	ftp://esx16-wsa01.qa/shd_logs	<input type="checkbox"/>	
snmp_logs	SNMP Logs	ftp://esx16-wsa01.qa/snmp_logs	<input type="checkbox"/>	
sntpd_logs	NTP Logs	ftp://esx16-wsa01.qa/sntpd_logs	<input type="checkbox"/>	
sophos_logs	Sophos Logs	ftp://esx16-wsa01.qa/sophos_logs	<input type="checkbox"/>	
status	Status Logs	ftp://esx16-wsa01.qa/status	<input type="checkbox"/>	
system_logs	System Logs	ftp://esx16-wsa01.qa/system_logs	<input type="checkbox"/>	
trafmon_errlogs	Traffic Monitor Error Logs	ftp://esx16-wsa01.qa/trafmon_errlogs	<input type="checkbox"/>	
trafmonlogs	Traffic Monitor Logs	ftp://esx16-wsa01.qa/trafmonlogs	<input type="checkbox"/>	
uds_logs	UDS Logs	ftp://esx16-wsa01.qa/uds_logs	<input type="checkbox"/>	
updater_logs	Updater Logs	ftp://esx16-wsa01.qa/updater_logs	<input type="checkbox"/>	
wbnp_logs	WBNP Logs	ftp://esx16-wsa01.qa/wbnp_logs	<input type="checkbox"/>	
webcat_logs	Web Categorization Logs	ftp://esx16-wsa01.qa/webcat_logs	<input type="checkbox"/>	
webrootlogs	Webroot Logs	ftp://esx16-wsa01.qa/webrootlogs	<input type="checkbox"/>	
welcomeack_logs	Welcome Page Acknowledgement Logs	ftp://esx16-wsa01.qa/welcomeack_logs	<input type="checkbox"/>	

By default, the appliance is configured with one log subscription for most log types. You can add, edit, or delete log subscriptions. You can retrieve log files from the appliance using SCP, FTP, or Syslog. You can create multiple log subscriptions for each type of log file.

The appliance includes more options when configuring the access log:

- **Include additional information in each log entry.** For more information about customizing the access log, see [Custom Formatting in Access Logs and W3C Logs](#), page 24-28.
- **Choose the format of the information.** You can choose among the following format options:
  - Apache
  - Squid
  - Squid Details

- **Exclude entries based on HTTP status codes.** You can configure the access log to not include transactions based on particular HTTP status codes to filter out certain transactions. For example, you might want to filter out authentication failure requests that have codes of 407 or 401.

## Log File Name and Appliance Directory Structure

The appliance creates a directory for each log subscription based on the log subscription name. The name of the log file in the directory is composed of the following information:

- Log file name specified in the log subscription
- Timestamp when the log file was started
- A single-character status code, either `.c` (signifying current) or `.s` (signifying saved)

The filename of logs are made using the following formula:

```
/LogSubscriptionName/LogFilename.@timestamp.statuscode
```



**Note**

---

You should only transfer log files with the saved status.

---

## Rolling Over Log Subscriptions

To prevent log files on the appliance from becoming too large, AsyncOS performs a “rollover” and archives a log file when it reaches a user-specified maximum file size or time interval and creates a new file for incoming log data. Based on the retrieval method defined for the log subscription, AsyncOS stores the older log file on the appliance for retrieval or delivers it to an external computer. See [Table 24-4 on page 24-13](#) for more information on how to retrieve log files from the appliance.

When AsyncOS rolls over a log file, it performs the following actions:

- Renames the current log file with the timestamp of the rollover and a letter `.s` extension signifying saved.
- Creates a new log file with the timestamp of the rollover and designates the file as current with the letter `.c` extension.
- Transfers the newly saved log file to a remote host if the log retrieval method is push-based. For a list of the log retrieval methods, see [Table 24-4 on page 24-13](#).
- Transfers any existing log files from the same subscription that were not transferred successfully during an earlier attempt (if using the push-based retrieval method).
- Deletes the oldest file in the log subscription if the total number of files to keep on the appliance has been exceeded if using the poll-based retrieval method.

AsyncOS rolls over log subscriptions in the following ways:

- **Manually.** The appliance administrator can manually roll over log subscriptions on demand from either the web interface or the CLI. Use the **Rollover Now** button on the System Administration > Log Subscriptions page, or the `rollovernow` CLI command. The `rollovernow` command allows you to roll over all log files at once or select a specific log file from a list.
- **Automatically.** AsyncOS rolls over log subscriptions based on the first user-specified limit reached: maximum file size or maximum time. Log subscriptions based on the FTP poll retrieval method create files and store them in the FTP directory on the appliance until they are retrieved from a remote FTP client, or until the system needs to create more space for log files.

## Manually Rolling Over Log Subscriptions Using the GUI

- 
- Step 1** On the System Administration > Log Subscriptions page, mark the checkbox to the right of the log subscriptions you wish to roll over.
  - Step 2** Optionally, you can select all log subscriptions for rollover by marking the All checkbox.
  - Step 3** Click **Rollover Now** to roll over the selected logs.
- 

## Automatically Rolling Over Log Subscriptions

You define a log subscription's rollover settings when creating or editing the subscription using the System Administration > Log Subscriptions page in the GUI or the `logconfig` command in the CLI. The two settings available for triggering a log file rollover are:

- **Maximum file size.** For more information, see [Rollover By File Size, page 24-9](#).
- **Time interval.** For more information, see [Rollover By Time, page 24-9](#).

Figure 24-2 shows the rollover settings available for log subscriptions.

**Figure 24-2 Log File Rollover Settings for Log Subscriptions**

Rollover by File Size:	<input type="text" value="10M"/> Maximum <small>(Add a trailing K or M to indicate size units)</small>
Rollover by Time:	<div style="border: 1px solid #ccc; padding: 2px; display: inline-block;">Custom Time Interval ▾</div> Rollover every: <input type="text" value="4h 30m"/> <small>(Example: 120s, 5m 30s, 4h, 2d)</small>

### Rollover By File Size

AsyncOS rolls over log files when they reach a maximum file size to prevent them from using too much disk space. When defining a maximum file size for rollovers, use the suffix `m` for megabytes and `k` for kilobytes. For example, enter `10m` if you want AsyncOS to roll over the log file when it reaches 10 megabytes.

### Rollover By Time

If you want to schedule rollovers to occur on a regular basis, you can select one of the following time intervals:

- **None.** AsyncOS only performs a rollover when the log file reaches the maximum file size.
- **Custom Time Interval.** AsyncOS performs a rollover after a specified amount of time has passed since the previous rollover. To create a custom time interval for scheduled rollovers, enter the number of days, hours, and minutes between rollovers using `d`, `h`, and `m` as suffixes.
- **Daily Rollover.** AsyncOS performs a rollover every day at a specified time. If you choose a daily rollover, enter the time of day you want AsyncOS to perform the rollover using the 24-hour format (HH:MM). Separate multiple times a day using a comma. Use an asterisk (\*) for the hour to specify that AsyncOS should perform the rollover every hour during the day. You can also use an asterisk to rollover every minute of an hour.

- **Weekly Rollover.** AsyncOS performs a rollover on one or more days of the week at a specified time. For example, you can set up AsyncOS to rollover the log file every Wednesday and Friday at midnight. To configure a weekly rollover, choose the days of the week to perform the rollover and the time of day in the 24-hour format (HH:MM).

If you are using the CLI, you can use a dash (-) to specify a range of days, an asterisk (\*) to specify every day of the week, or a comma (,) to separate multiple days and times.

Figure 24-3 shows the settings available for the Weekly Rollover option.

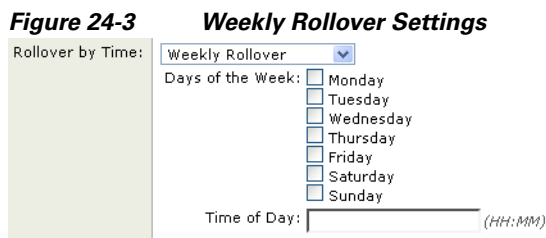

## Working with Compressed Log Files

To save disk space on the Web Security appliance, log subscriptions can compress rolled over log files before storing them on the disk. Only rolled over logs are compressed. The current active log file is not compressed.

Each log subscription has its own log compression setting, so you can choose which log subscriptions to compress. AsyncOS compresses log files using the gzip compression format.

## Viewing the Most Recent Log Files

You can view a the most recent version of a log file from the following locations:

- **Web interface.** On the System Administration > Log Subscriptions page, click the name of the log subscription in the Log Files column of the list of log subscriptions. When you click the link to the log subscription, AsyncOS prompts you to enter your password. Then it lists the available log files for that subscription. Click one of the log files to view it in your browser or to save it to disk.
- **Command line interface.** Use the `tail` CLI command. AsyncOS displays the configured log subscriptions and prompts you to select the log subscription to view. Use `Ctrl+C` to exit from the `tail` command at any time.



### Note

If a log subscription is compressed, you must download it before you can decompress and open it.

## Configuring Host Keys

Use the `logconfig -> hostkeyconfig` subcommand to manage host keys for use with SSH when pushing log files to other servers from the Web Security appliance. SSH servers must have a pair of host keys, one private and one public. The private host key resides on the SSH server and cannot be read by remote machines. The public host key is distributed to any client machine that needs to interact with the SSH server.



The `hostkeyconfig` subcommand performs the following functions:

**Table 24-2 Managing Host Keys—List of Subcommands**

Command	Description
New	Add a new key.
Scan	Automatically download a host key.
Host	Display system host keys. This is the value to place in the remote system's 'known_hosts' file.
Fingerprint	Display system host key fingerprints.
User	Displays the public key of the system account that pushes the logs to the remote machine. This is the same key that is displayed when setting up an SCP push subscription. This is the value to place in the remote system's 'authorized_keys' file.

## Adding and Editing Log Subscriptions

- Step 1** Navigate to the System Administration > Log Subscriptions page.
- Step 2** To add a log subscription, click **Add Log Subscription**. Or, to edit a log subscription, click the name of the log file in the Log Name field.
- Step 3** Select the type of log to associate with this subscription from the Log Type field.
- Step 4** Enter a name for the log subscription in the Log Name field.  
The appliance uses this name for the directory on the appliance that will contain the log file.
- Step 5** If you are creating an access log, configure the following options:

Access Log Option	Description
Log Style	Choose the log format to use, either Squid, Apache, or Squid Details.
Custom Fields	Optionally, enter the other type of information to include in each access log entry. For more information, see <a href="#">Custom Formatting in Access Logs and W3C Logs, page 24-28</a> .

- Step 6** If you are creating a W3C access log, configure the following options:

Access Log Option	Description
Log Fields	<p>Choose the fields you want to include in the W3C access log.</p> <p>Select a field in the Available Fields list, or type a field in the Custom Field box, and click <b>Add</b>. The order the fields appear in the Selected Log Fields list determines the order of fields in the W3C access log file. You can change the order of fields using the <b>Move Up</b> and <b>Move Down</b> buttons. You can remove a field by selecting it in the Selected Log Fields list and clicking <b>Remove</b>.</p> <p>You can enter multiple user defined fields in the Custom Fields box and add them simultaneously as long as each entry is separated by a new line (click Enter) before clicking <b>Add</b>.</p> <p>For more information, see <a href="#">W3C Compliant Access Logs, page 24-26</a>.</p>



**Note** When you change the log fields included in a W3C log subscription, the log subscription automatically rolls over. This allows the latest version of the log file to include the correct new field headers.

- Step 7** Enter a name for the log file in the File Name field.
- Step 8** Enter the maximum file size in bytes the log file can be in the Maximum File Size field. After the number, enter “G” to specify Gigabytes, “M” for Megabytes, or “K” for Kilobytes.
- Step 9** Choose whether or not to compress log files after they have been rolled over using the Log Compression field.

For more information, see [Working with Compressed Log Files, page 24-10](#).

- Step 10** (Optional) Specify HTTP status codes (4xx or 5xx only) in the Log Exclusions field to exclude the associated transactions from an access log or a W3C access log.
- For example, you might want to filter out authentication failure requests that have codes of 407 or 401.
- Step 11** Choose the amount of detail to include in the log file in the Log Level field.

The Log Level field does not appear for access and W3C access logs subscriptions

More detailed settings create larger log files and have a greater impact on system performance. More detailed settings include all the messages contained in less detailed settings, plus additional messages. As the level of detail increases, system performance decreases.

[Table 24-3](#) describes the levels of detail you can choose in the Log Level field.

**Table 24-3 Logging Levels**

Log Level	Description
Critical	This is the least detailed setting. This level only includes errors. Using this setting will not allow you to monitor performance and other important activities. However, the log files will not reach their maximum size as quickly. This log level is equivalent to the syslog level “Alert.”
Warning	This level includes all errors and warnings created by the system. Using this setting will not allow you to monitor performance and other important activities. This log level is equivalent to the syslog level “Warning.”
Information	This level includes the detailed system operations. This is the default. This log level is equivalent to the syslog level “Info.”
Debug	This level includes data useful for debugging system problems. Use the Debug log level when you are trying to discover the cause of an error. Use this setting temporarily, and then return to the default level. This log level is equivalent to the syslog level “Debug.”
Trace	This is the most detailed setting. This level includes a complete record of system operations and activity. The Trace log level is recommended only for developers. Using this level causes a serious degradation of system performance and is not recommended. This log level is equivalent to the syslog level “Debug.”

- Step 12** Choose how to retrieve the log file from the appliance in the Retrieval Method field.

Table 24-4 describes the different ways you can retrieve log files:

**Table 24-4 Log Transfer Protocols**

Retrieval Method	Description
FTP on Appliance (FTP Poll)	<p>This method requires a remote FTP client accessing the appliance to retrieve log files using an admin or operator user's username and password.</p> <p>When you choose this method, you must enter the maximum number of log files to store on the appliance. When the maximum number is reached, the system deletes the oldest file.</p> <p>This is the default.</p>
FTP on Remote Server (FTP Push)	<p>This method periodically pushes log files to an FTP server on a remote computer.</p> <p>When you choose this method, you must enter the following information:</p> <ul style="list-style-type: none"> <li>• Maximum time between file transfers</li> <li>• FTP server hostname</li> <li>• Directory on FTP server to store the log file</li> <li>• Username and password of a user that has permission to connect to the FTP server</li> </ul> <p><b>Note:</b> AsyncOS for Web only supports passive mode for remote FTP servers. It cannot push log files to an FTP server in active mode.</p>
SCP on Remote Server (SCP Push)	<p>This method periodically pushes log files using the secure copy protocol to an SCP server on a remote computer. This method requires an SSH SCP server on a remote computer using the SSH2 protocol. The subscription requires a user name, SSH key, and destination directory on the remote computer. Log files are transferred based on a rollover schedule set by you.</p> <p>When you choose this method, you must enter the following information:</p> <ul style="list-style-type: none"> <li>• Maximum time between file transfers</li> <li>• Protocol to use for transmission</li> <li>• SCP server hostname</li> <li>• Directory on SCP server to store the log file</li> <li>• Username of a user that has permission to connect to the SCP server</li> </ul> <p>Choose whether or not to enable host key checking.</p>
Syslog Push	<p>This method sends log messages to a remote syslog server. This method conforms to RFC 3164. The appliance uses port 514.</p> <p>When you choose this method, you must enter the following information:</p> <ul style="list-style-type: none"> <li>• Syslog server hostname</li> <li>• Protocol to use for transmission, either UDP or TCP</li> <li>• Facility to use with the log</li> </ul> <p>You can only choose syslog for text-based logs.</p> <p><b>Note</b> Syslog messages greater than 1024 bytes are truncated. Access logs and W3C access logs with many custom variables, especially of variable length, might exceed the 1024 byte limit.</p>

- Step 13** Submit and commit your changes.
- Step 14** If you chose SCP as the retrieval method, the appliance displays an SSH key to you must place on the SCP server host.

## Deleting a Log Subscription

- Step 1** Navigate to the System Administration > Log Subscriptions page.
- Step 2** Click the icon under the Delete column for the log subscription you want to delete.
- Step 3** Submit and commit your changes.

## Access Log File

The access log file provides a descriptive record of all Web Proxy filtering and scanning activity. Access log file entries display a record of how the appliance handled each transaction. You can view the access log file from the System Administration > Log Subscriptions page.



### Note

The W3C access log also records all Web Proxy filtering and scanning activity, but in a format that is W3C compliant. For more information, see [W3C Compliant Access Logs, page 24-26](#).

The following text is an example access log file entry for a single transaction:

```
1278096903.150 97 172.xx.xx.xx TCP_MISS/200 8187 GET http://my.site.com/ -
DIRECT/my.site.com text/plain
DEFAULT_CASE_11-AccessOrDecryptionPolicy-Identity-OutboundMalwareScanningPolicy-DataSecu
rityPolicy-ExternalDLPPolicy-RoutingPolicy
<IW_comp,6.9,-,"-",-,-,-,-,"-",-,-,-,"-",-,-,-,"-",-,-,IW_comp,-,"-","-", "Unknown", "Un
known", "-","-",198.34,0,-,[Local],"-","-"> -
```

[Table 24-5](#) describes the different fields in the access log file entry.

**Table 24-5 Access Log File Entry Fields**

Format Specifier	Field Value	Field Description
%t	1278096903.150	Timestamp since UNIX epoch.
%e	97	Elapsed time (latency) in milliseconds.
%a	172.xx.xx.xx	Client IP address. <b>Note:</b> You can choose to mask the IP address in the access logs using the <code>advancedproxyconfig &gt; authentication</code> CLI command.
%w	TCP_MISS	Transaction result code. For more information, see <a href="#">Transaction Result Codes, page 24-17</a> .
%h	200	HTTP response code.

Table 24-5 Access Log File Entry Fields (continued)

Format Specifier	Field Value	Field Description
%s	8187	Response size (headers + body).
%2r	GET http://my.site.com/	<p>First line of the request.</p> <p><b>Note:</b> When the first line of the request is for a native FTP transaction, some special characters in the file name are URL encoded in the access logs. For example, the “@” symbol is written as “%40” in the access logs.</p> <p>The following characters are URL encoded:</p> <p>&amp; # % + , : ; = @ ^ { } [ ]</p>
%A	-	<p>Authenticated username.</p> <p><b>Note:</b> You can choose to mask the username in the access logs using the <code>advancedproxyconfig &gt; authentication CLI</code> command.</p>
%H	DIRECT	<p>Code that describes which server was contacted for the retrieving the request content.</p> <p>Most common values include:</p> <ul style="list-style-type: none"> <li>• <b>NONE.</b> The Web Proxy had the content, so it did not contact any other server to retrieve the content.</li> <li>• <b>DIRECT.</b> The Web Proxy went to the server named in the request to get the content.</li> <li>• <b>DEFAULT_PARENT.</b> The Web Proxy went to its primary parent proxy or an external DLP server to get the content.</li> </ul>
%d	my.site.com	Data source or server IP address.
%c	text/plain	Response body MIME type.
%D	DEFAULT_CASE_11	<p>ACL decision tag.</p> <p><b>Note:</b> The end of the ACL decision tag includes a dynamically generated number that the Web Proxy uses internally. You can ignore this number.</p> <p>For more information, see <a href="#">ACL Decision Tags, page 24-17</a>.</p>
N/A (Part of the ACL decision tag)	AccessOrDecryptionPolicy	<p>Access Policy or Decryption Policy group name. When the transaction matches the global Access Policy or global Decryption Policy, this value is “DefaultGroup.”</p> <p>Any space in the policy group name is replaced with an underscore ( _ ).</p>
N/A (Part of the ACL decision tag)	Identity	<p>Identity policy group name.</p> <p>Any space in the policy group name is replaced with an underscore ( _ ).</p>
N/A (Part of the ACL decision tag)	OutboundMalwareScanningPolicy	<p>Outbound Malware Scanning Policy group name.</p> <p>Any space in the policy group name is replaced with an underscore ( _ ).</p>

Table 24-5 Access Log File Entry Fields (continued)

Format Specifier	Field Value	Field Description
N/A (Part of the ACL decision tag)	DataSecurityPolicy	Cisco IronPort Data Security Policy group name. When the transaction matches the global Cisco IronPort Data Security Policy, this value is “DefaultGroup.” This policy group name only appears when Cisco IronPort Data Security Filters is enabled. “NONE” appears when no Data Security Policy was applied.  Any space in the policy group name is replaced with an underscore ( _ ).
N/A (Part of the ACL decision tag)	ExternalDLPPolicy	External DLP Policy group name. When the transaction matches the global External DLP Policy, this value is “DefaultGroup.” “NONE” appears when no External DLP Policy was applied.  Any space in the policy group name is replaced with an underscore ( _ ).
N/A (Part of the ACL decision tag)	RoutingPolicy	Routing Policy group name as <i>ProxyGroupName/ProxyServerName</i> .  When the transaction matches the global Routing Policy, this value is “DefaultRouting.” When no upstream proxy server is used, this value is “DIRECT.”  Any space in the policy group name is replaced with an underscore ( _ ).
%Xr	<IW_comp,6.9,-,-,"-",-,-,-,-,"-",-,-,-,-,"-","-",-,-,IW_comp,-,"-","-","Unknown","Unknown","-","-","198.34,0,-,[Local],"-,"- ">	Scanning verdict information. Inside the angled brackets, the access logs include verdict information from various scanning engines.  For more information about the values included within the angled brackets, see <a href="#">Understanding Scanning Verdict Information, page 24-21</a> .
%?BLOCK_SUSPECT_USER_AGENT,MONITOR_SUSPECT_USER_AGENT?%<User-Agent:%!%-%.	-	Suspect user agent.

## Transaction Result Codes

Transaction result codes in the access log file describe how the appliance resolves client requests. For example, if a request for an object can be resolved from the cache, the result code is `TCP_HIT`. However, if the object is not in the cache and the appliance pulls the object from an origin server, the result code is `TCP_MISS`. The following table describes transaction result codes.

**Table 24-6** Transaction Result Codes

Result Code	Description
<code>TCP_HIT</code>	The object requested was fetched from the disk cache.
<code>TCP_IMS_HIT</code>	The client sent an IMS (If-Modified-Since) request for an object and the object was found in the cache. The proxy responds with a 304 response.
<code>TCP_MEM_HIT</code>	The object requested was fetched from the memory cache.
<code>TCP_MISS</code>	The object was not found in the cache, so it was fetched from the origin server.
<code>TCP_REFRESH_HIT</code>	The object was in the cache, but had expired. The proxy sent an IMS (If-Modified-Since) request to the origin server, and the server confirmed that the object has not been modified. Therefore, the appliance fetched the object from either the disk or memory cache.
<code>TCP_CLIENT_REFRESH_MISS</code>	The client sent a “don’t fetch response from cache” request by issuing the ‘Pragma: no-cache’ header. Due to this header from the client, the appliance fetched the object from the origin server.
<code>TCP_DENIED</code>	The client request was denied due to Access Policies.
<code>NONE</code>	There was an error in the transaction. For example, a DNS failure or gateway timeout.

## ACL Decision Tags

An ACL decision tag is a field in an access log entry that indicates how the Web Proxy handled the transaction. It includes information from the Web Reputation filters, URL categories, and the scanning engines.



### Note

The end of the ACL decision tag includes a dynamically generated number that the Web Proxy uses internally to increase performance. You can ignore this number.

Table 24-7 describes the ACL decision tag values.

**Table 24-7** ACL Decision Tag Values

ACL Decision Tag	Description
<code>ALLOW_ADMIN_ERROR_PAGE</code>	The Web Proxy allowed the transaction to an IronPort notification page and to any logo used on that page.
<code>ALLOW_CUSTOMCAT</code>	The Web Proxy allowed the transaction based on custom URL category filtering settings for the Access Policy group.
<code>ALLOW_WBRS</code>	The Web Proxy allowed the transaction based on the Web Reputation filter settings for the Access Policy group.

**Table 24-7** ACL Decision Tag Values (continued)

ACL Decision Tag	Description
BLOCK_ADMIN	The Web Proxy blocked the transaction based on some default settings for the Access Policy group.
BLOCK_ADMIN_CONNECT	The Web Proxy blocked the transaction based on the TCP port of the destination as defined in the HTTP CONNECT Ports setting for the Access Policy group.
BLOCK_ADMIN_CUSTOM_USER_AGENT	The Web Proxy blocked the transaction based on the user agent as defined in the Block Custom User Agents setting for the Access Policy group.
BLOCK_ADMIN_IDS	The Web Proxy blocked the transaction based on the MIME type of the request body content as defined in the Data Security Policy group.
BLOCK_ADMIN_FILE_TYPE	The Web Proxy blocked the transaction based on the file type as defined in the Access Policy group.
BLOCK_ADMIN_PROTOCOL	The Web Proxy blocked the transaction based on the protocol as defined in the Block Protocols setting for the Access Policy group.
BLOCK_ADMIN_SIZE	The Web Proxy blocked the transaction based on the size of the response as defined in the Object Size settings for the Access Policy group.
BLOCK_ADMIN_SIZE_IDS	The Web Proxy blocked the transaction based on the size of the request body content as defined in the Data Security Policy group.
BLOCK_AMW_REQ	The Web Proxy blocked the request based on the Anti-Malware settings for the Outbound Malware Scanning Policy group. The request body produced a positive malware verdict.
BLOCK_AMW_RESP	The Web Proxy blocked the response based on the Anti-Malware settings for the Access Policy group.
BLOCK_AMW_REQ_URL	The Web Proxy suspects the URL in the HTTP request might not be safe, so it blocked the transaction at request time based on the Anti-Malware settings for the Access Policy group.
BLOCK_AVC	The Web Proxy blocked the transaction based on the configured Application settings for the Access Policy group.
BLOCK_CONTENT_UNSAFE	The Web Proxy blocked the transaction based on the site content ratings settings for the Access Policy group. The client request was for adult content and the policy is configured to block adult content.
BLOCK_CONTINUE_CONTENT_UNSAFE	The Web Proxy blocked the transaction and displayed the Warn and Continue page based on the site content ratings settings in the Access Policy group. The client request was for adult content and the policy is configured to give a warning to users accessing adult content.



**Table 24-7 ACL Decision Tag Values (continued)**

<b>ACL Decision Tag</b>	<b>Description</b>
BLOCK_CONTINUE_CUSTOMCAT	The Web Proxy blocked the transaction and displayed the Warn and Continue page based on a custom URL category in the Access Policy group configured to “Warn.”
BLOCK_CONTINUE_WEBCAT	The Web Proxy blocked the transaction and displayed the Warn and Continue page based on a predefined URL category in the Access Policy group configured to “Warn.”
BLOCK_CUSTOMCAT	The Web Proxy blocked the transaction based on custom URL category filtering settings for the Access Policy group.
BLOCK_ICAP	The Web Proxy blocked the request based on the verdict of the external DLP system as defined in the External DLP Policy group.
BLOCK_SEARCH_UNSAFE	The client request included an unsafe search query and the Access Policy is configured to enforce safe searches, so the original client request was blocked.
BLOCK_SUSPECT_USER_AGENT	The Web Proxy blocked the transaction based on the Suspect User Agent setting for the Access Policy group.
BLOCK_UNSUPPORTED_SEARCH_APP	The Web Proxy blocked the transaction based on the safe search settings for the Access Policy group. The transaction was for an unsupported search engine, and the policy is configured to block unsupported search engines.
BLOCK_WBRS	The Web Proxy blocked the transaction based on the Web Reputation filter settings for the Access Policy group.
BLOCK_WBRS_IDS	The Web Proxy blocked the upload request based on the Web Reputation filter settings for the Data Security Policy group.
BLOCK_WEBCAT	The Web Proxy blocked the transaction based on URL category filtering settings for the Access Policy group.
BLOCK_WEBCAT_IDS	The Web Proxy blocked the upload request based on the URL category filtering settings for the Data Security Policy group.
DECRYPT_ADMIN	The Web Proxy decrypted the transaction based on some default settings for the Decryption Policy group.
DECRYPT_WEBCAT	The Web Proxy decrypted the transaction based on URL category filtering settings for the Decryption Policy group.
DECRYPT_WBRS	The Web Proxy decrypted the transaction based on the Web Reputation filter settings for the Decryption Policy group.
DEFAULT_CASE	The Web Proxy allowed the client to access the server because none of the AsyncOS services, such as Web Reputation or anti-malware scanning, took any action on the transaction.
DROP_ADMIN	The Web Proxy dropped the transaction based on some default settings for the Decryption Policy group.

**Table 24-7 ACL Decision Tag Values (continued)**

ACL Decision Tag	Description
DROP_WEBCAT	The Web Proxy dropped the transaction based on URL category filtering settings for the Decryption Policy group.
DROP_WBRS	The Web Proxy dropped the transaction based on the Web Reputation filter settings for the Decryption Policy group.
MONITOR_AMW_RESP	The Web Proxy monitored the server response based on the Anti-Malware settings for the Access Policy group.
MONITOR_AMW_RESP_URL	The Web Proxy suspects the URL in the HTTP request might not be safe, but it monitored the transaction based on the Anti-Malware settings for the Access Policy group.
MONITOR_AVC	The Web Proxy monitored the transaction based on the Application settings for the Access Policy group.
MONITOR_CONTINUE_CONTENT_UNSAFE	Originally, the Web Proxy blocked the transaction and displayed the Warn and Continue page based on the site content ratings settings in the Access Policy group. The client request was for adult content and the policy is configured to give a warning to users accessing adult content. The user accepted the warning and continued to the originally requested site, and no other scanning engine subsequently blocked the request.
MONITOR_CONTINUE_CUSTOMCAT	Originally, the Web Proxy blocked the transaction and displayed the Warn and Continue page based on a custom URL category in the Access Policy group configured to “Warn.” The user accepted the warning and continued to the originally requested site, and no other scanning engine subsequently blocked the request.
MONITOR_CONTINUE_WEBCAT	Originally, the Web Proxy blocked the transaction and displayed the Warn and Continue page based on a predefined URL category in the Access Policy group configured to “Warn.” The user accepted the warning and continued to the originally requested site, and no other scanning engine subsequently blocked the request.
MONITOR_IDS	The Web Proxy scanned the upload request using either a Data Security Policy or an External DLP Policy, but did not block the request. It evaluated the request against the Access Policies.
MONITOR_SUSPECT_USER_AGENT	The Web Proxy monitored the transaction based on the Suspect User Agent setting for the Access Policy group.
MONITOR_WBRS	The Web Proxy monitored the transaction based on the Web Reputation filter settings for the Access Policy group.
NO_AUTHORIZATION	The Web Proxy did not allow the user access to the SaaS application because the user was already authenticated against an authentication realm, but not against any authentication realm configured in the SaaS Application Authentication Policy.
NO_PASSWORD	The user failed authentication.

**Table 24-7** ACL Decision Tag Values (continued)

ACL Decision Tag	Description
PASSTHRU_ADMIN	The Web Proxy passed through the transaction based on some default settings for the Decryption Policy group.
PASSTHRU_WEBCAT	The Web Proxy passed through the transaction based on URL category filtering settings for the Decryption Policy group.
PASSTHRU_WBRS	The Web Proxy passed through the transaction based on the Web Reputation filter settings for the Decryption Policy group.
REDIRECT_CUSTOMCAT	The Web Proxy redirected the transaction to a different URL based on a custom URL category in the Access Policy group configured to “Redirect.”
SAAS_AUTH	The Web Proxy allowed the user access to the SaaS application because the user was authenticated transparently against the authentication realm configured in the SaaS Application Authentication Policy.
OTHER	The Web Proxy did not complete the request due to an error, such as an authorization failure, server disconnect, or an abort from the client.

## Understanding Scanning Verdict Information

The access log file entries aggregate and display the results of the various scanning engines, such as URL filtering, Web Reputation filtering, and anti-malware scanning. The appliance displays this information in angled brackets at the end of each access log entry.

The following text is the scanning verdict information from an access log file entry. In this example, the Webroot scanning engine found the malware:

```
<IW_infr,ns,24,"Trojan-Phisher-Gamec",0,354385,12559,-,"-",-,-,-,"-",-,-,"-","-",-,-,IW_infr,-,"Trojan Phisher","-","Unknown","Unknown","-","-",489.73,0,[Local],"-","->
```



### Note

For an example of a whole access log file entry, see [Access Log File, page 24-14](#).

Table 24-8 describes the different fields in the scanning verdict information section of each access log file entry.

**Table 24-8 Access Log File Entry – Scanning Verdict Information**

Position and Format Specifier	Field Value	Description
position 1 %XC	IW_infr	The URL category assigned to the transaction, abbreviated. This field shows “nc” when no category is assigned.  For a list of URL category abbreviations, see <a href="#">URL Category Descriptions, page 17-25</a> .
position 2 %XW	ns	Web Reputation filters score. This field either shows the score as a number, “ns” for “no score,” or “dns” when there is a DNS lookup error.
position 3 %Xv	24	The malware scanning verdict Webroot passed to the DVS engine.  Applies to responses detected by Webroot only.  For more information, see <a href="#">Malware Scanning Verdict Values, page 24-38</a> .
position 4 “%Xn”	“Trojan-Phisher-Gamec ”	Name of the spyware that is associated with the object.  Applies to responses detected by Webroot only.
position 5 %Xt	0	The Webroot specific value associated with the Threat Risk Ratio (TRR) value that determines the probability that malware exists.  Applies to responses detected by Webroot only.
position 6 %Xs	354385	A value that Webroot uses as a threat identifier. Cisco IronPort Customer Support may use this value when troubleshooting an issue.  Applies to responses detected by Webroot only.
position 7 %Xi	12559	A value that Webroot uses as a trace identifier. Cisco IronPort Customer Support may use this value when troubleshooting an issue.  Applies to responses detected by Webroot only.
position 8 %Xd	-	The malware scanning verdict McAfee passed to the DVS engine.  Applies to responses detected by McAfee only.  For more information, see <a href="#">Malware Scanning Verdict Values, page 24-38</a> .
position 9 “%Xe”	“-”	The name of the file McAfee scanned.  Applies to responses detected by McAfee only.
position 10 %Xf	-	A value that McAfee uses as a scan error. Cisco IronPort Customer Support may use this value when troubleshooting an issue.  Applies to responses detected by McAfee only.
position 11 %Xg	-	A value that McAfee uses as a detection type. Cisco IronPort Customer Support may use this value when troubleshooting an issue.  Applies to responses detected by McAfee only.
position 12 %Xh	-	A value that McAfee uses as a virus type. Cisco IronPort Customer Support may use this value when troubleshooting an issue.  Applies to responses detected by McAfee only.

Table 24-8 Access Log File Entry – Scanning Verdict Information (continued)

Position and Format Specifier	Field Value	Description
position 13 “%Xj”	“-”	The name of the virus that McAfee scanned. Applies to responses detected by McAfee only.
position 14 %XY	-	The malware scanning verdict Sophos passed to the DVS engine. Applies to responses detected by Sophos only. For more information, see <a href="#">Malware Scanning Verdict Values, page 24-38</a> .
position 15 %Xx	-	A value that Sophos uses as a scan return code. Cisco IronPort Customer Support may use this value when troubleshooting an issue. Applies to responses detected by Sophos only.
position 16 “%Xy”	“-”	The file location where Sophos found the objectionable content. For non-archive files, this value is the file name itself. For archive file, it is the object in the archive, such as <code>archive.zip/virus.exe</code> . Applies to responses detected by Sophos only.
position 17 “%Xz”	“-”	A value that Sophos uses as the threat name. Cisco IronPort Customer Support may use this value when troubleshooting an issue. Applies to responses detected by Sophos only.
position 18 %Xl	-	The Cisco IronPort Data Security scan verdict based on the action in the Content column of the Cisco IronPort Data Security Policy. The following list describes the possible values for this field: <ul style="list-style-type: none"> <li>• <b>0.</b> Allow</li> <li>• <b>1.</b> Block</li> <li>• <b>- (hyphen).</b> No scanning was initiated by the Cisco IronPort Data Security Filters. This value appears when the Cisco IronPort Data Security Filters is disabled or when the URL category action is set to Allow.</li> </ul>
position 19 %Xp	-	The External DLP scan verdict based on the result given in the ICAP response. The following list describes the possible values for this field: <ul style="list-style-type: none"> <li>• <b>0.</b> Allow</li> <li>• <b>1.</b> Block</li> <li>• <b>- (hyphen).</b> No scanning was initiated by the external DLP server. This value appears when External DLP scanning is disabled or when the content was not scanned due to an exempt URL category on the External DLP Policies &gt; Destinations page.</li> </ul>
position 20 %XQ	IW_infr	The URL category verdict determined during request-side scanning, abbreviated. This field lists a hyphen ( - ) when URL filtering is disabled. For a list of URL category abbreviations, see <a href="#">URL Category Descriptions, page 17-25</a> .

Table 24-8 Access Log File Entry – Scanning Verdict Information (continued)

Position and Format Specifier	Field Value	Description
position 21 %XA	-	The URL category verdict determined by the Dynamic Content Analysis engine during response-side scanning, abbreviated. Applies to the Cisco IronPort Web Usage Controls URL filtering engine only. Only applies when the Dynamic Content Analysis engine is enabled and when no category is assigned at request time (a value of “nc” is listed in the request-side scanning verdict).  For a list of URL category abbreviations, see <a href="#">URL Category Descriptions, page 17-25</a> .
position 22 “%XZ”	“Trojan Phisher”	Unified response-side anti-malware scanning verdict that provides the malware category independent of which scanning engines are enabled. Applies to transactions blocked or monitored due to server response scanning.
position 23 “%Xk”	“-”	The threat type returned by the Web Reputation filters which resulted in the target website receiving a poor reputation. Typically, this field is populated for sites at reputation of -4 and below.
position 24 “%XO”	“Unknown”	The application name as returned by the AVC engine, if applicable. Only applies when the AVC engine is enabled.
position 25 “%Xu”	“Unknown”	The application type as returned by the AVC engine, if applicable. Only applies when the AVC engine is enabled.
position 26 “%Xb”	“-”	The application behavior as returned by the AVC engine, if applicable. Only applies when the AVC engine is enabled.
position 27 “%XS”	“-”	Safe browsing scanning verdict. This value indicates whether or not either the safe search or site content ratings feature was applied to the transaction.  For a list of the possible values, see <a href="#">Logging Adult Content Access, page 17-18</a> .
position 28 %XB	489.73	The average bandwidth consumed serving the request in Kb per second.
position 29 %XT	0	A value that indicates whether or not the request was throttled due to bandwidth limit control settings. “1” indicates the request was throttled, “0” indicates it was not.
position 30 %l	[Local]	The type of user making the request, either “[Local]” or “[Remote].” Only applies when AnyConnect Secure Mobility is enabled. When it is not enabled, the value is a hyphen (-).
position 31 “%X3”	“-”	Unified request-side anti-malware scanning verdict independent of which scanning engines are enabled. Applies to transactions blocked or monitored due to client request scanning when an Outbound Malware Scanning Policy applies.
position 32 “%X4”	“-”	The threat name assigned to the client request that was blocked or monitored due to an applicable Outbound Malware Scanning Policy.  This threat name is independent of which anti-malware scanning engines are enabled.

## Web Reputation Filters Example

In the following example, the URL request was allowed because the URL's Web Reputation score was high enough to qualify to be allowed without being scanned for malware.

```
1278100150.818 1303 172.xx.xx.xx TCP_MISS/200 46578 GET http://www.cisco.com/ -
DIRECT/www.cisco.com - ALLOW_WBRS_11-AccessPolicy-Identity-NONE-NONE-NONE-DefaultGroup
<IW_comp,6.5,-,"-",-,-,-,-,"-",-,-,-,"-",-,-,"-","-",-,-,IW_comp,-,"-","-", "Unknown", "Un
known", "-","-",285.97,0,-,[Local],"-","-"> -
```

In this example, “6.5” is the Web Reputation score. The hyphen “-” values indicate the request was not forwarded to the DVS engine for anti-malware scanning. The ACL decision tag “ALLOW\_WBRS” indicates that the request was allowed, and therefore not forwarded for anti-malware scanning, based on this Web Reputation score.

## Anti-Malware Request Example

In the following example, the Webroot scanning engine scanned the URL request and assigned a malware scanning verdict based on the URL request. Webroot is the only scanning engine that scans a URL request. For more information about Webroot scanning, see [Webroot Scanning, page 19-6](#).

```
1278106367.381 170 172.xx.xx.xx TCP_DENIED/403 1828 GET http://www.gator.com/ - NONE/- -
BLOCK_AMW_REQ_URL_11-AccessPolicy-Identity-OMSPolicy-NONE-NONE-NONE
<IW_busi,3.4,13,"GAIN - Common
Components",95,37607,10,-,"-",-,-,-,"-",-,-,"-","-",-,-,IW_busi,-,"Adware","-", "Unknown"
,"Unknown", "-","-",86.02,0,-,[Local],"-","-">
```

In this example, “3.4” is the Web Reputation score, indicating to scan the website for malware. Therefore, the Web Proxy passed the request to the DVS engine for anti-malware scanning.

The 13 value corresponds to “Adware” which is the malware scanning verdict that Webroot passed to the DVS engine. The “BLOCK\_AMW\_REQ\_URL” ACL decision tag shows that Webroot’s request-side checking of the URL produced this verdict. The remainder of the fields show the malware name (“GAIN - Common Components”), threat risk rating (“95”), threat ID (“37607”), and trace ID (“10”) values, which Webroot derived from its evaluation. All of the McAfee and Sophos-related values are empty (“-”) because neither the McAfee or Sophos scanning engine scanned the URL request.

## Anti-Malware Response Example

In the following example, the McAfee scanning engine scanned the server response, assigned a malware scanning verdict based on the server response, and blocked it from the user.

```
1278097193.276 51 172.xx.xx.xx TCP_DENIED/403 3122 GET http://badsite.com/malware.exe -
DIRECT/badsite.com application/x-dosexec
BLOCK_AMW_RESP_11-AccessPol-Identity-NONE-NONE-NONE-DefaultGroup
<IW_infr,3.0,24,"Trojan-Phisher-Gamec",0,354385,12559,
-,"-",-,-,-,"-",-,-,"-","-",-,-,IW_infr,-,"Trojan
Phisher", "-","Unknown", "Unknown", "-","-",489.73,0,[Local],"-","-"> -
```

The following list explains the values in this access log entry that show that this transaction was blocked based on the result of the Webroot scanning engine:

- **TCP\_DENIED.** The website was denied due to Access Policies.

- **BLOCK\_AMW\_RESP\_11-AccessPol.** This transaction matched the “AccessPol” Access Policy group, and due to the settings defined in that policy group, the server response was blocked due to detected malware.
- **3.0 in the angled brackets.** The URL received a Web Reputation Score of 3.0, which fell in the score range to scan further.
- **24 in the angled brackets.** The malware scanning verdict Webroot passed to the DVS engine which corresponds to Trojan Phisher.
- **“Trojan-Phisher-Gamec”.** The name of the malware that Webroot scanned.

## W3C Compliant Access Logs

The Web Security appliance provides two different log types for recording Web Proxy transaction information, the access logs and the W3C access logs. The W3C access logs are W3C compliant, and record transaction history in the W3C Extended Log File (ELF) Format.

You can create multiple W3C access log subscriptions and define the data to include in each. You might want to create one W3C access log that includes all information your organization typically needs, and other, specialized W3C access logs that can be used for troubleshooting purposes or special analysis. For example, you might want to create a W3C access log for an HR manager that only needs access to certain information.

Consider the following rules and guidelines when working with W3C access logs:

- You define what data is recorded in each W3C access log subscription.
- The W3C logs are self-describing. The file format (list of fields) is defined in a header at the start of each log file.
- Fields in the W3C access logs are separated by a white space.
- If a field contains no data for a particular entry, a hyphen ( - ) is included in the log file instead.
- Each line in the W3C access log file relates to one transaction, and each line is terminated by a LF sequence.
- When defining a W3C access log subscription, you can choose from a list of predefined log fields or enter a custom log field. For more information, see [Working with Log Fields in W3C Access Logs, page 24-27](#).
- If you want to use a third party log analyzer tool to read and parse the W3C access logs, you might need to include the “timestamp” field. The timestamp W3C field displays time since the UNIX epoch, and most log analyzers only understand time in this format.
- If you want to copy the log fields included in a W3C access log in their order, use the `logconfig > edit` CLI command. The CLI displays the log fields in order, from which you can copy and then paste them into a separate Web Security appliance web interface.

## W3C Log File Headers

Each W3C log file contains header text at the beginning of the file. Each line starts with the # character and provides information about the Web Security appliance that created the log file. The W3C log file headers also include the file format (list of fields), making the log file self-describing.



Table 24-9 describes the header fields listed at the beginning of each W3C log file.

**Table 24-9 W3C Log File Header Fields**

Header Field	Description
Version	The version of the W3C ELF format used.
Date	The date and time at which the entry was added.
System	The Web Security appliance that generated the log file in the format “Management_IP - Management_hostname.”
Software	The Software which generated these logs
Fields	The fields recorded in the log

For example, a W3C log file might contain the following header information:

```
#Version: 1.0
#Date: 2009-06-15 13:55:20
#System: 10.1.1.1 - wsa.qa
#Software: AsyncOS for Web 6.3.0
#Fields: timestamp x-elapsed-time c-ip x-resultcode-httpstatus sc-bytes cs-method cs-url
cs-username x-hierarchy-origin cs-mime-type x-acltag x-result-code x-suspect-user-agent
```

## Working with Log Fields in W3C Access Logs

When defining a W3C access log subscription, you must choose which log fields to include, such as the ACL decision tag or the client IP address. You can include one of the following types of log fields:

- **Predefined.** The web interface includes a list of fields from which you can choose. For more information, see [Custom Formatting in Access Logs and W3C Logs, page 24-28](#).
- **User defined.** You can type a log field that is not included in the predefined list. For more information, see [Including HTTP/HTTPS Headers in Log Files, page 24-37](#).

Most W3C log field names include a prefix that identifies from which header a value comes, such as the client or server. Log fields without a prefix reference values that are independent of the computers involved in the transaction. [Table 24-10 on page 24-27](#) describes the W3C log fields prefixes.

**Table 24-10 W3C Log Field Prefixes**

Prefix Header	Description
c	Client
s	Server
cs	Client to server
sc	Server to client
x	Application specific identifier.

For example, the W3C log field “cs-method” refers to the method in the request sent by the client to the server, and “c-ip” refers to the client’s IP address.

## Custom Formatting in Access Logs and W3C Logs

You can customize access logs and W3C access logs to include many different fields to capture comprehensive information about web traffic within the network. Access logs use format specifiers, and the W3C access logs use W3C log fields.

Table 24-11 describes the W3C log fields you can include in the W3C access logs and the custom format specifiers (for the access logs) they correspond with.

**Table 24-11** Log Fields in W3C Logs and Format Specifiers in Access Logs

W3C Log Field	Format Specifier in Access Logs	Description
—	%XP	Unrecognized header. Use this field to log extra headers in client requests. This supports troubleshooting of specialized systems that add headers to client requests as a way of authenticating and redirecting those requests, for example, YouTube for Schools.
bytes	%B	Total bytes used (request size + response size, which is %q + %s)
c-ip	%a	Client IP Address
c-port	%F	Client source port
CMF	%M	Cache miss flags, CMF flags
cs(Cookie)	%C	Cookie header. This field is written with double-quotes in the access logs.
cs(Referer)	%<Referer:	Referer
cs(User-Agent)	%u	User agent. This field is written with double-quotes in the access logs.
cs(X-Forwarded-For)	%f	X-Forwarded-For header
cs-auth-group	%g	Authorized group names. This field is written with double-quotes in the access logs.

Table 24-11 Log Fields in W3C Logs and Format Specifiers in Access Logs (continued)

W3C Log Field	Format Specifier in Access Logs	Description
cs-auth-mechanism	%m	The authentication mechanism used on the transaction. Possible values are: <ul style="list-style-type: none"> <li>• <b>BASIC.</b> The user name was authenticated using the Basic authentication scheme.</li> <li>• <b>NTLMSSP.</b> The user name was authenticated using the NTLMSSP authentication scheme.</li> <li>• <b>SSO_TUI.</b> The user name was obtained by matching the client IP address to an authenticated user name using transparent user identification.</li> <li>• <b>SSO_ASA.</b> The user is a remote user and the user name was obtained from a Cisco ASA using the Secure Mobility.</li> <li>• <b>FORM_AUTH.</b> The user entered authentication credentials in a form in the web browser when accessing a SaaS application.</li> <li>• <b>GUEST.</b> The user failed authentication and instead was granted guest access.</li> </ul>
cs-bytes	%q	Request size (headers + body)
cs-method	%y	Method
cs-mime-type	%c	Response body MIME type. This field is written with double-quotes in the access logs.
x-req-first-line	%r	Request first line - request method, URI.
cs-uri	%U	Request URI
cs-url	%Y	The entire URL
cs-username	%A	Authenticated user name. This field is written with double-quotes in the access logs.
cs-version	%P	Protocol
date	%v	Date in YYYY-MM-DD
DCF	%j	Do not cache response code; DCF flags
s-computerName	%N	Server name or destination hostname. This field is written with double-quotes in the access logs.
s-hierarchy	%H	Hierarchy retrieval
s-hostname	%d	Data source or server IP address
s-ip	%k	Data source IP address (server IP address)
s-port	%p	Destination port number

**Table 24-11** Log Fields in W3C Logs and Format Specifiers in Access Logs (continued)

W3C Log Field	Format Specifier in Access Logs	Description
sc(Server)	%>Server:	Server header in the response
sc-body-size	%b	Bytes sent to the client from the Web Proxy for the body content.
sc-bytes	%s	Response size (header + body)
sc-http-status	%h	HTTP response code
sc-result-code	%w	Result code For example: TCP_MISS, TCP_HIT
sc-result-code-denial	%W	Result code denial
time	%V	Time in HH:MM:SS
timestamp	%t	Timestamp in UNIX epoch  <b>Note:</b> If you want to use a third party log analyzer tool to read and parse the W3C access logs, you might need to include the “timestamp” field. Most log analyzers only understand time in the format provided by this field.
user-type	%l	Type of user, either local or remote. For more information, see <a href="#">Working with Remote Users, page 14-2</a> .
x-acltag	%D	ACL decision tag
x-as-malware-threat-name	%X6	Indicates whether or not Adaptive Scanning blocked the transaction without invoke any anti-malware scanning engine. The possible values are: <ul style="list-style-type: none"> <li>• <b>1</b>. Transaction was blocked.</li> <li>• <b>0</b>. Transaction was not blocked.</li> </ul> This variable is included in the scanning verdict information (in the angled brackets at the end of each access log entry).
x-avc-app	%XO	The web application identified by the AVC engine.
x-avc-behavior	%Xb	The web application behavior identified by the AVC engine.
x-avc-reqbody-scanverdict	%XH	AVC request body verdict
x-avc-reqbody-scanverdict	%XN	AVC response body verdict
x-avc-reqhead-scanverdict	%XG	AVC request header verdict
x-avc-resphd-scanverdict	%XM	AVC response header verdict
x-avc-type	%Xu	The web application type identified by the AVC engine.

**Table 24-11** Log Fields in W3C Logs and Format Specifiers in Access Logs (continued)

W3C Log Field	Format Specifier in Access Logs	Description
x-avg-bw	%XB	Average bandwidth of the user if bandwidth limits are defined by the AVC engine.
x-bw-throttled	%XT	Flag that indicates whether or not bandwidth limits were applied to the transaction.
x-elapsed-time	%e	Elapsed time
x-error-code	%E	Error code number that may help Customer Support troubleshoot the reason for a failed transaction.
x-hierarchy-origin	N/A	Code that describes which server was contacted for the retrieving the request content. (e.g. DIRECT/www.example.com)
x-icap-server	%i	IP address of the last ICAP server contacted while processing the request
x-icap-verdict	%Xp	External DLP server scanning verdict
x-ids-verdict	%Xl	Cisco IronPort Data Security Policy scanning verdict. If this field is included, it will display the IDS verdict, or “0” if IDS was active but the document scanned clean, or “-” if no IDS policy was active for the request.
x-latency	%x	Latency
x-local_time	%L	Request local time in human readable format: DD/MMM/YYYY : hh:mm:ss +nnnn. This field is written with double-quotes in the access logs.
x-mcafee-av-detecttype	%Xg	McAfee specific identifier: (detect type)
x-mcafee-av-scanerror	%Xf	McAfee specific identifier: (scan error)
x-mcafee-av-virustype	%Xh	McAfee specific identifier: (virus type)
x-mcafee-filename	%Xe	McAfee specific identifier: (File name yielding verdict) This field is written with double-quotes in the access logs.
x-mcafee-scanverdict	%Xd	McAfee specific identifier: (scan verdict)
x-mcafee-virus-name	%Xj	McAfee specific identifier: (virus name). This field is written with double-quotes in the access logs.
x-req-dvs-scanverdict	%X2	Request side DVS Scan verdict
x-req-dvs-threat-name	%X4	Request side DVS threat name
x-req-dvs-verdictname	%X3	Request side DVS verdict name
x-request-source-ip	%XV	The downstream IP address when the “Enable Identification of Client IP Addresses using X-Forwarded-For” check box is enabled for the Web Proxy settings.

Table 24-11 Log Fields in W3C Logs and Format Specifiers in Access Logs (continued)

W3C Log Field	Format Specifier in Access Logs	Description
x-request-rewrite	%XS	Safe browsing scanning verdict. Indicates whether or not either the safe search or site content ratings feature was applied to the transaction. For more information, see <a href="#">Logging Adult Content Access, page 17-18</a> .
x-resp-dvs-scanverdict	%X0	Unified response-side anti-malware scanning verdict that provides the <i>malware category number</i> independent of which scanning engines are enabled. Applies to transactions blocked or monitored due to server response scanning. This field is written with double-quotes in the access logs.
x-resp-dvs-threat-name	%X1	Unified response-side anti-malware scanning verdict that provides the <i>malware threat name</i> independent of which scanning engines are enabled. Applies to transactions blocked or monitored due to server response scanning. This field is written with double-quotes in the access logs.
x-resp-dvs-verdictname	%XZ	Unified response-side anti-malware scanning verdict that provides the <i>malware category</i> independent of which scanning engines are enabled. Applies to transactions blocked or monitored due to server response scanning. This field is written with double-quotes in the access logs.
x-result-code	%Xr	Scanning verdict information
x-resultcode-httpstatus	N/A	Result code and the HTTP response code, with a slash (/) in between.
x-sophos-file-name	%Xy	The file location where Sophos found the objectionable content. For non-archive files, this value is the file name itself. For archive file, it is the object in the archive, such as <code>archive.zip/virus.exe</code> .
x-sophos-scanerror	%Xx	Sophos specific identifier: (scan return code)
x-sophos-scanverdict	%XY	Sophos specific identifier: (scan verdict)
x-sophos-virus-name	%Xz	Sophos specific identifier: (threat name)

**Table 24-11** Log Fields in W3C Logs and Format Specifiers in Access Logs (continued)

W3C Log Field	Format Specifier in Access Logs	Description
x-suspect-user-agent	;%?BLOCK_SUSPECT_USER_AGENT, MONITOR_SUSPECT_USER_AGENT?%;<User-Agent:;%!%-%.	Suspect user agent, if applicable. If the Web Proxy determines the user agent is suspect, it will log the user agent in this field. Otherwise, it logs a hyphen. This field is written with double-quotes in the access logs.
x-transaction-id	%I	Transaction ID
x-wbrs-score	%XW	Decoded WBRs score <-10.0-10.0>
x-wbrs-threat-reason	%XK	Web reputation threat reason
x-wbrs-threat-type	%Xk	Web reputation threat type
x-webcat-code-abbr	%XC	URL category abbreviation for the URL category assigned to the transaction.
x-webcat-code-full	%XF	Full name of the URL category assigned to the transaction. This field is written with double-quotes in the access logs.
x-webcat-req-code-abbr	%XQ	The URL category verdict determined during request-side scanning, abbreviated.
x-webcat-req-code-full	%XR	The URL category verdict determined during request-side scanning, full name.
x-webcat-resp-code-abbr	%XA	The URL category verdict determined during response-side scanning, abbreviated. Applies to the Cisco IronPort Web Usage Controls URL filtering engine only.
x-webcat-resp-code-full	%XL	The URL category verdict determined during response-side scanning, full name. Applies to the Cisco IronPort Web Usage Controls URL filtering engine only.
x-webroot-scanverdict	%Xv	Malware scanning verdict from Webroot
x-webroot-spyid	%Xs	Webroot specific identifier: (Spy ID)
x-webroot-threat-name	%Xn	Webroot specific identifier: (Threat name) This field is written with double-quotes in the access logs.
x-webroot-trace-id	%Xi	Webroot specific scan identifier: (Trace ID)
x-webroot-trr	%Xt	Webroot specific identifier: (Threat Risk Ratio (TRR))
x-p2s-first-byte-time	%;<1	The time it takes from the moment the Web Proxy starts connecting to the server to the time it is first able to write to the server. If the Web Proxy has to connect to several servers to complete the transaction, it is the sum of those times.
x-s2p-first-byte-time	%;>1	Wait-time for first response byte from server

**Table 24-11** Log Fields in W3C Logs and Format Specifiers in Access Logs (continued)

W3C Log Field	Format Specifier in Access Logs	Description
x-c2p-first-byte-time	%:l<	Wait-time for first request byte from new client connection
x-p2c-first-byte-time	%:l>	Wait-time for first byte written to client
x-p2p-auth-wait-time	%:<a	Wait-time to receive the response from the Web Proxy authentication process, after the Web Proxy sent the request.
x-p2p-auth-svc-time	%:>a	Wait-time to receive the response from the Web Proxy authentication process, including the time required for the Web Proxy to send the request.
x-p2p-avc-svc-time	%:A<	Wait-time to receive the response from the AVC process, including the time required for the Web Proxy to send the request.
x-p2p-avc-wait-time	%:A>	Wait-time to receive the response from the AVC process, after the Web Proxy sent the request.
x-p2s-body-time	%:<b	Wait-time to write request body to server after header
x-s2p-body-time	%:>b	Wait-time for complete response body after header received
x-c2p-body-time	%:b<	Wait-time for complete client body
x-p2c-body-time	%:b>	Wait-time for complete body written to client
x-p2p-fetch-time	%:>c	Time required for the Web Proxy to read a response from the disk cache.
x-p2p-dca-resp-wait-time	%:C>	Wait-time to receive the response from the Dynamic Content Analysis engine, after the Web Proxy sent the request.
x-p2p-dca-resp-svc-time	%:C<	Wait-time to receive the verdict from the Dynamic Content Analysis engine, including the time required for the Web Proxy to send the request.
x-p2p-dns-wait-time	%:<d	Wait-time to receive the response from the Web Proxy DNS process, after the Web Proxy sent the request.
x-p2p-dns-svc-time	%:>d	Wait-time to receive the response from the Web Proxy DNS process, including the time required for the Web Proxy to send the request.
x-p2s-header-time	%:<h	Wait-time to write request header to server after first byte
x-s2p-header-time	%:>h	Wait-time for server header after first response byte



**Table 24-11** Log Fields in W3C Logs and Format Specifiers in Access Logs (continued)

W3C Log Field	Format Specifier in Access Logs	Description
x-c2p-header-time	:%h<	Wait-time for complete client header after first byte
x-s2p-header-time	:%h>	Wait-time for complete header written to client
x-p2p-mcafee-resp-svc-time	:%m<	Wait-time to receive the verdict from the McAfee scanning engine, including the time required for the Web Proxy to send the request.
x-p2p-mcafee-resp-wait-time	:%m>	Wait-time to receive the response from the McAfee scanning engine, after the Web Proxy sent the request.
x-p2p-sophos-resp-svc-time	:%p<	Wait-time to receive the verdict from the Sophos scanning engine, including the time required for the Web Proxy to send the request.
x-p2p-sophos-resp-wait-time	:%p>	Wait-time to receive the response from the Sophos scanning engine, after the Web Proxy sent the request.
x-p2p-reputation-wait-time	:%<r	Wait-time to receive the response from the Web Reputation Filters, after the Web Proxy sent the request.
x-p2p-reputation-svc-time	:%>r	Wait-time to receive the verdict from the Web Reputation Filters, including the time required for the Web Proxy to send the request.
x-p2p-asw-req-wait-time	:%<s	Wait-time to receive the verdict from the Web Proxy anti-spyware process, after the Web Proxy sent the request.
x-p2p-asw-req-svc-time	:%>s	Wait-time to receive the verdict from the Web Proxy anti-spyware process, including the time required for the Web Proxy to send the request.
x-p2p-webroot-resp-svc-time	:%w<	Wait-time to receive the verdict from the Webroot scanning engine, including the time required for the Web Proxy to send the request.
x-p2p-webroot-resp-wait-time	:%w>	Wait-time to receive the response from the Webroot scanning engine, after the Web Proxy sent the request.

## Configuring Custom Formatting in Access Logs

Use the System Administration > Log Subscriptions page to configure custom formatting for access log file entries. Click the access log file name to edit the access log subscription.

**Figure 24-4** Configuring Custom Log Fields in the Access Logs

### Edit Log Subscription

Log Subscription	
Log Type:	Access Logs
Log Name:	accesslogs <small>(will be used to name the log directory)</small>
Log Style:	<input checked="" type="radio"/> Squid <input type="radio"/> Apache <input type="radio"/> Squid Details
Custom Fields (optional):	<input type="text"/> <a href="#">Custom Fields Reference</a>

The syntax for entering format specifiers in the Custom Field is as follows:

```
<format_specifier1> <format_specifier2>
```

For example: %a %b %E

You can add tokens before the format specifiers to display descriptive text in the access log file. For example:

```
client_IP %a body_bytes %b error_type %E
```

where `client_IP` is the description token for log format specifier %a, `body_bytes` is the descriptive token for %b, and `error_type` is the descriptive token for %E.



#### Note

You can create a custom field for any header in a client request or a server response. For more information, see [Including HTTP/HTTPS Headers in Log Files, page 24-37](#).

## Configuring Custom Formatting in W3C Logs

Use the System Administration > Log Subscriptions page to configure custom formatting for W3C log file entries. Click the W3C log file name to edit the W3C log subscription.

Figure 24-5 Configuring Custom Log Fields in the W3C Logs

The screenshot shows the 'Log Subscription' configuration window. At the top, 'Log Type' is set to 'W3C Logs'. Below that is a 'Log Name' field with a note: '(will be used to name the log directory)'. The main area is divided into 'Available Log Fields' and 'Selected Log Fields'. The 'Available Log Fields' list includes: CMF, DCF, bytes, c-ip, c-port, cs(Cookie), cs(Referer), cs(User-Agent), cs(X-Forwarded-For), cs-auth-group, cs-auth-mechanism, cs-bytes, cs-method, cs-mime-type, cs-uri, cs-url, cs-username, and cs-version. The 'Selected Log Fields' list includes: timestamp, x-elapsed-time, c-ip, sc-result-code, sc-http-status, sc-bytes, cs-method, cs-uri, cs-username, s-hierarchy, s-hostname, cs-mime-type, x-acttag, x-result-code, and x-suspect-user-agent. There are 'Add >>', 'Move Up', 'Move Down', and 'Remove' buttons. At the bottom, there is a 'Custom Fields' text box with a note: '(Use line breaks to separate multiple entries)'.

Enter the custom fields to add in the Custom Fields text box in the Log Fields section. You can enter multiple custom fields in the Custom Fields text box and add them simultaneously as long as each entry is separated by a new line (click Enter) before clicking **Add**.

**Note**

You can create a custom field for any header in a client request or a server response. For more information, see [Including HTTP/HTTPS Headers in Log Files, page 24-37](#).

## Including HTTP/HTTPS Headers in Log Files

If the list of predefined access log and W3C log fields does not include all header information you want to log from HTTP/HTTPS transactions, you can type a user defined log field in the Custom Fields text box when you configure the access and W3C log subscriptions.

Custom log fields can be any data from any header sent from the client or the server. If a request or response does not include the header added to the log subscription, the log file includes a hyphen as the log field value.

Table 24-12 defines the syntax to use for access and W3C logs.

**Table 24-12** Configuring HTTP/HTTPS Headers in Log Files

Header Type	Access Log Format Specifier Syntax	W3C Log Custom Field Syntax
Header from the client application	<code>%&lt;ClientHeaderName:</code>	<code>cs(&lt;ClientHeaderName&gt;)</code>
Header from the server	<code>%&lt;ServerHeaderName:</code>	<code>sc(&lt;ServerHeaderName&gt;)</code>

For example, if you want to log the If-Modified-Since header value in client requests, enter the following text in the Custom Fields box for a W3C log subscription:

```
cs (If-Modified-Since)
```

## Malware Scanning Verdict Values

A malware scanning verdict is a value assigned to a URL request or server response that determines the probability that it contains malware. The scanning engines return the malware scanning verdict to the DVS engine so the DVS engine can determine whether to monitor or block the scanned object.

They are the result of proprietary calculations that associate a numerical value to the probability that either the URL request or the response content contains malware. Each malware scanning verdict corresponds to a malware category listed on the Access Policies > Reputation and Anti-Malware Settings page when you edit the anti-malware settings for a particular Access Policy.

Webroot, McAfee, and Sophos scanning engines can return malware scanning verdicts to the DVS engine. For more information about how the DVS engine handles malware scanning verdicts, see [Cisco IronPort DVS™ \(Dynamic Vectoring and Streaming\) Engine, page 19-4](#).

Table 24-13 lists the different Malware Scanning Verdict Values and each malware category with which they correspond.

**Table 24-13 Malware Scanning Verdict Values**

Malware Scanning Verdict Value	Malware Category
-	Not Set
0	Unknown
1	Not Scanned
2	Timeout
3	Error
4	Unscannable
10	Generic Spyware
12	Browser Helper Object
13	Adware
14	System Monitor
18	Commercial System Monitor
19	Dialer
20	Hijacker
21	Phishing URL
22	Trojan Downloader
23	Trojan Horse
24	Trojan Phisher
25	Worm
26	Encrypted File
27	Virus
33	Other Malware
34	PUA
35	Aborted
36	Outbreak Heuristics

# Traffic Monitor Log

The L4 Traffic Monitor log file provides a detailed record of monitoring activity. You can view L4 Traffic Monitor log file entries and track updates to firewall block lists and firewall allow lists. Consider the following example log entries:

## Example 1

```
172.xx.xx.xx discovered for blocksite.net (blocksite.net) added to firewall block list.
```

In this example, where a match becomes a block list firewall entry. The L4 Traffic Monitor matched an IP address to a domain name in the block list based on a DNS request which passed through the appliance. The IP address is then entered into the block list for the firewall.

## Example 2

```
172.xx.xx.xx discovered for www.allowsite.com (www.allowsite.com) added to firewall allow list.
```

In this example, a match becomes an allow list firewall entry. The L4 Traffic Monitor matched a domain name entry and added it to the appliance allow list. The IP address is then entered into the allow list for the firewall.

## Example 3

```
Firewall noted data from 172.xx.xx.xx to 209.xx.xx.xx (allowsite.net):80.
```

In this example, the L4 Traffic Monitor logs a record of data that passed between an internal IP address and an external IP address which is on the block list. Also, the L4 Traffic Monitor is set to monitor, not block.

# Troubleshooting

AsyncOS for Web sends a critical email message to the configured alert recipients when the internal logging process drops web transaction events due to a full buffer.

By default, when the Web Proxy experiences a very high load, the internal logging process buffers events to record them later when the Web Proxy load decreases. When the logging buffer fills completely, the Web Proxy continues to process traffic, but the logging process does not record some events in the access logs or in the Web Tracking report. This might occur during a spike in web traffic.

However, a full logging buffer might also occur when the appliance is over capacity for a sustained period of time. AsyncOS for Web continues to send the critical email messages every few minutes until the logging process is no longer dropping data.

The critical message contains the following text:

```
Reporting Client: The reporting system is unable to maintain the rate of data being generated. Any new data generated will be lost.
```

If AsyncOS for Web sends this critical message continuously or frequently, the appliance might be over capacity. Contact Cisco IronPort Customer Support to verify whether or not you need additional Web Security appliance capacity.



# 25

## Configuring Network Settings

---

- [Changing the System Hostname, page 25-1](#)
- [Configuring Network Interfaces, page 25-2](#)
- [Configuring TCP/IP Traffic Routes, page 25-4](#)
- [Virtual Local Area Networks \(VLANs\), page 25-6](#)
- [Configuring Transparent Redirection, page 25-11](#)
- [Configuring SMTP Relay Hosts, page 25-16](#)
- [Configuring DNS Server\(s\), page 25-17](#)

### Changing the System Hostname

The hostname parameter is used to identify the system at the CLI prompt. You must enter a fully-qualified hostname for the system. The hostname parameter is also used in end-user notification pages, end-user acknowledgement pages, and to form the machine NetBIOS name when the Web Security appliance joins an Active Directory domain. It has no direct relationship with the hostname configured for the interface.

Use the `sethostname` command to change the name of the Web Security appliance:

```
example.com> sethostname  
  
example.com> hostname.com  
  
example.com> commit
```

# Configuring Network Interfaces

You can configure the appliance network interfaces by modifying IP address, subnet, and hostname information for the Management, Data, and L4 Traffic Monitor interfaces. [Table 25-1](#) describes the network interface settings you can configure.

**Table 25-1** Web Security Appliance Network Interface Settings

Interface	Port Number	Description
Management	M1	By default, the Management interface is used to administer the appliance and Web Proxy (data) monitoring. However, you can configure the M1 port for management use only.
Data	P1 and P2 (proxy)	The Data interfaces are used for Web Proxy monitoring and L4 Traffic Monitor blocking (optional). You can also configure these interfaces to support outbound services such as DNS, software upgrades, NTP, and traceroute data traffic.  For more information about configuring the Data interfaces, see <a href="#">Configuring the Data Interfaces, page 25-2</a> .
L4 Traffic Monitor	T1 and T2	The L4 Traffic Monitor interfaces are used to configure a duplex or simplex wiring type. <ul style="list-style-type: none"> <li>• <b>Duplex.</b> The T1 interface receives incoming and outgoing traffic.</li> <li>• <b>Simplex.</b> T1 receives outgoing traffic and T2 receives incoming traffic.</li> </ul>



## Note

If the Management and Data interfaces are all configured, each must be assigned IP addresses on different subnets.

You can manage the network interfaces using the following methods:

- **Web interface.** Use the Network > Interfaces page. For more information, see [Configuring the Network Interfaces from the Web Interface, page 25-3](#).
- **Command line interface.** Use the `ifconfig` CLI command to create, edit, and delete network interfaces.

## Configuring the Data Interfaces

You can configure the Web Security appliance to use any of the following combinations of network interfaces for data traffic:

- M1 only
- M1 and P1
- M1, P1, and P2
- P1 only
- P1 and P2



You can enable the M1 and P1 ports during or after System Setup. However, you can only enable the P2 port after System Setup in the web interface or using the `ifconfig` CLI command.

The Web Proxy listens for client web requests on different network interfaces depending on how you configure the Web Security appliance:

- **M1.** The Web Proxy listens for requests on this interface when it is not configured to be restricted to appliance management services only.
- **P1.** The Web Proxy listens for requests on this interface when it is enabled.
- **P2.** By default, the Web Proxy does not listen for requests on this interface, even when enabled. However, you can configure it to listen for requests on P2 using the `advancedproxyconfig > miscellaneous` CLI command.

To configure the appliance to use P2 as a second data interface:

**Step 1** Configure the appliance to use P1 as the interface for data traffic. You can do this during System Setup or after initial setup on the Network > Interfaces page.

**Step 2** Enable P2 in the web interface (see [Configuring the Network Interfaces from the Web Interface, page 25-3](#)) or using the `ifconfig` CLI command.



**Note** If the Management and Data interfaces are all configured, each must be assigned IP addresses on different subnets.

**Step 3** In the web interface, go to the Network > Routes page. Change the Default Route for data traffic to specify the next IP address that the P2 interface is connected to.



**Note** If you enable P2 to listen for client requests using the `advancedproxyconfig > miscellaneous` CLI command, you can choose whether to use P1 or P2 for outgoing traffic. To use P1 for outgoing traffic, change the Default Route for data traffic to specify the next IP address that the P1 interface is connected to.

## Configuring the Network Interfaces from the Web Interface

**Step 1** Navigate to the Network > Interfaces page. Click **Edit Settings**.

**Step 2** Configure interface settings as necessary.

[Table 25-2](#) describes the interface settings you can define for each interface.

**Table 25-2** *Interface Settings*

Interface Setting	Description
IP Address	Enter the IP address to use to manage the Web Security appliance. Enter an IP address that exists on your management network.

**Table 25-2** *Interface Settings (continued)*

Interface Setting	Description
Netmask	Enter the network mask to use when managing the Web Security appliance on this network interface.
Hostname	Enter the hostname to use when managing the Web Security appliance on this network interface.

**Step 3** Specify whether or not to have separate routing for the Management Services using the “Restrict M1 port to appliance management services only” field.

If this checkbox is selected, the M1 port is used for appliance management services only and is not used for the data (Web Proxy) traffic. You will need to configure another port for data traffic as well as separate routes for management and data traffic. For more information about configuring routes, see [Configuring TCP/IP Traffic Routes, page 25-4](#).

**Step 4** Configure Appliance Management Services.

Choose whether or not to use HTTP or HTTPS to administer AsyncOS through the web interface. You must specify the port to access AsyncOS with each protocol you configure.

You can also choose to redirect HTTP requests to HTTPS. When you do this, AsyncOS automatically enables both HTTP and HTTPS.

**Step 5** Choose the type of wired connections plugged into the “T” network interfaces:

- **Duplex TAP.** Choose Duplex TAP when the T1 port receives both incoming and outgoing traffic. You can use half- or full-duplex Ethernet connections.
- **Simplex TAP.** Choose Simplex TAP when you connect the T1 port to the internal network (traffic flows from the clients to the Internet) and you connect the T2 port to the external network (traffic flows from the Internet to the clients).



**Note** Cisco recommends using simplex when possible because it can increase performance and security.

**Step 6** Submit and commit your changes.

## Configuring TCP/IP Traffic Routes

You can define routes for appliance traffic, add static routes, load IP routing tables, and modify the default gateway using the Network > Routes page or the `routeconfig` command.

Routes are used for determining where to send traffic (routing traffic). The Web Security appliance needs to route the following kinds of traffic:

- **Data traffic.** Traffic the Web Proxy processes from end users browsing the web.
- **Management traffic.** Traffic created by managing the appliance through the web interface and traffic the appliance creates for management services, such as AsyncOS upgrades, component updates, DNS, authentication, and more.

By default, both kinds of traffic use the routes defined for all configured network interfaces. However, you can choose to split the routes (“split routing”) so that the M1 interface is only used for management traffic. When you enable split routing, data traffic only uses the routes configured for the data interfaces (P1 and P2, if configured), and management traffic uses the routes configured for all configured network interfaces.

To enable split routing, use the “Restrict M1 port to appliance management services only” field on the Network > Interfaces page. For more information, see [Configuring the Network Interfaces from the Web Interface](#), page 25-3.

The number of sections on the Network > Routes page is determined by whether or not split routing is enabled:

- **Separate route configuration sections for Management and Data traffic (split routing enabled).** When you use the Management interface for management traffic only (“Restrict M1 port” is enabled), then this page includes two sections to enter routes, one for management traffic and one for data traffic. [Figure 25-1 on page 25-5](#) shows the Routes page when the option is enabled.
- **One route configuration section for all traffic (split routing disabled).** When you use the Management interface for both management and data traffic (“Restrict M1 port” is disabled), then this page includes one section to enter routes for all traffic that leaves the Web Security appliance, both management and data traffic.

**Note**

A route gateway must reside on the same subnet as the Management or Data interface on which it is configured.

## Modifying the Default Route

You can modify the default gateway in the web interface or in the CLI using the `setgateway` CLI command.

**Note**

The Web Proxy sends out transactions on the data interface that is on the same network as the default gateway configured for data traffic.

To modify the default gateway in the web interface:

- Step 1** Navigate to the Network > Routes page, and click on Default Route in the corresponding table.

**Figure 25-1** *Editing the Default Route*

Edit Default Route for Management and Data (Interface M1: 10.1.1.1, Interface P1: 10.1.2.1)

Default Gateway Settings		
Name	Destination Network	Gateway
Default Route	All Others (Including External)	10.5.5.1

- Step 2** In the Gateway column, enter the IP address of the computer system on the next hop of the network connected to the network interface you are editing.
- Step 3** Submit and commit your changes.

## Working With Routing Tables

You can save your current routing table to a file. You can load a previously saved route table. You can add new routes or delete existing ones.

To save a route table, click **Save Route Table** and specify where to save the file.

To load a previously saved route table, click **Load Route Table**, navigate to the file, and then submit and commit your changes.

**Note**

---

When the destination address is on the same subnet as one of the physical network interfaces, AsyncOS sends data using the network interface with the same subnet. It does not consult the routing tables.

---

## Adding a Route

- 
- Step 1** Navigate to the Network > Routes page.
  - Step 2** Click the **Add Route** button corresponding to the interface for which you are creating the route.
  - Step 3** Enter a Name, Destination Network, and Gateway.
  - Step 4** Submit and commit your changes.
- 

## Virtual Local Area Networks (VLANs)

VLANs are virtual local area networks bound to physical data ports. You can configure one or more VLANs to increase the number of networks the IronPort appliance can connect to beyond the number of physical interfaces included. For example, a Web Security appliance has two data interfaces available for VLANs: P1 and Management. VLANs allow more networks to be defined on separate “ports” on existing interfaces. [Figure 25-2](#) provides an example of configuring several VLANs on the P1 interface.

**Figure 25-2** Using VLANs to Increase the Number of Networks Available on the Appliance

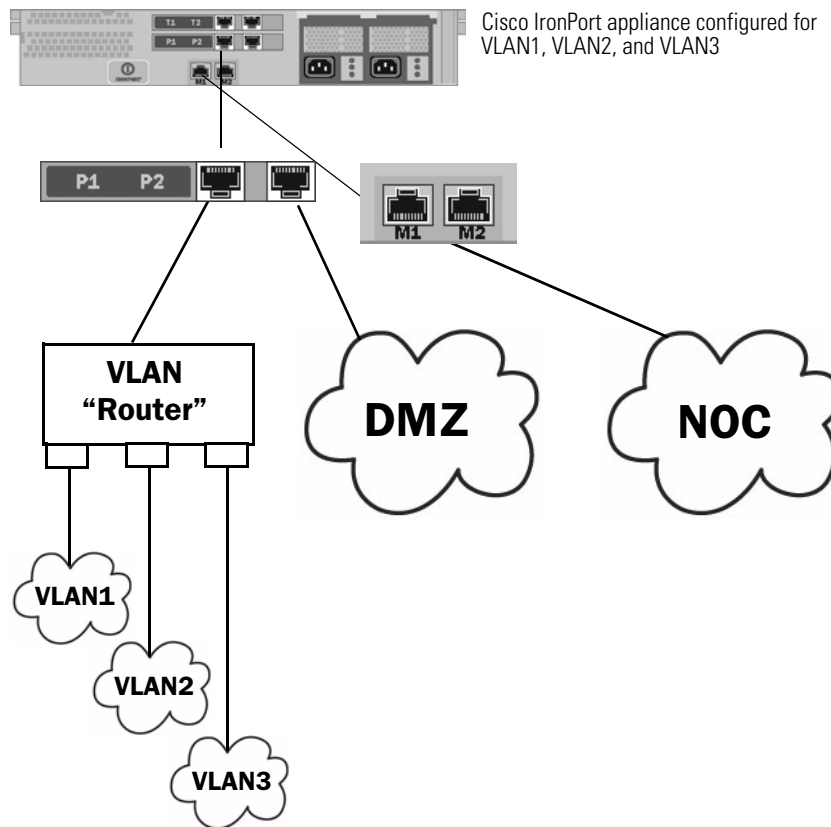

VLANs can be used to segment networks for security purposes, to ease administration, or increase bandwidth. For example, create multiple VLANs on the P1 interface and then apply different policies to each. VLANs appear as dynamic “Data Ports” labeled in the format of: “VLAN DDDD” where the “DDDD” is the ID and is an integer up to 4 digits long (VLAN 2, or VLAN 4094 for example). AsyncOS supports up to 30 VLANs. Duplicate VLAN IDs are not allowed on an IronPort appliance.

## VLANs and Physical Ports

A physical port does not need an IP address configured in order to be in a VLAN. The physical port on which a VLAN is created can have an IP that will receive non-VLAN traffic, so you can have both VLAN and non-VLAN traffic on the same interface.

VLANs can only be created on the Management and P1 data ports.

## Managing VLANs

You can create, edit and delete VLANs via the `etherconfig` command. Once created, a VLAN can be configured via the `interfaceconfig` command in the CLI. Remember to commit all changes.

### Creating a New VLAN via the `etherconfig` Command

In this example, two VLANs are created (named VLAN 31 and VLAN 34) on the P1 port:

**Note**

---

Do not create VLANs on the T1 or T2 interfaces.

---

```
example.com> etherconfig
```

```
Choose the operation you want to perform:
```

- MEDIA - View and edit ethernet media settings.
- VLAN - View and configure VLANs.
- MTU - View and configure MTU.

```
[> vlan
```

```
VLAN interfaces:
```

```
Choose the operation you want to perform:
```

- NEW - Create a new VLAN.

```
[> new
```

```
VLAN ID for the interface (Ex: "34"):
```

```
[> 34
```

```
Enter the name or number of the ethernet interface you wish bind to:
```

1. Management
2. P1
3. T1
4. T2

```
[1]> 2
```

```
VLAN interfaces:
```

1. VLAN 34 (P1)

```
Choose the operation you want to perform:
```

- NEW - Create a new VLAN.
- EDIT - Edit a VLAN.
- DELETE - Delete a VLAN.

[> **new**

VLAN ID for the interface (Ex: "34"):

[> **31**

Enter the name or number of the ethernet interface you wish bind to:

1. Management
2. P1
3. T1
4. T2

[1]> **2**

VLAN interfaces:

1. VLAN 31 (P1)
2. VLAN 34 (P1)

Choose the operation you want to perform:

- NEW - Create a new VLAN.
- EDIT - Edit a VLAN.
- DELETE - Delete a VLAN.

[>

## Creating an IP Interface on a VLAN via the `interfaceconfig` Command

In this example, a new IP interface is created on the VLAN 34 ethernet interface.

**Note**

---

Making changes to an interface may close your connection to the appliance.

---

```
example.com> interfaceconfig
```

```
Currently configured interfaces:
```

1. Management (10.10.1.10/24 on Management: example.com)
2. P1 (10.10.0.10 on P1: example.com)

```
Choose the operation you want to perform:
```

- NEW - Create a new interface.
- EDIT - Modify an interface.
- GROUPS - Define interface groups.
- DELETE - Remove an interface.

```
[> new
```

```
IP Address (Ex: 10.10.10.10):
```

```
[> 10.10.31.10
```

```
Ethernet interface:
```

1. Management
2. P1
3. VLAN 31
4. VLAN 34

```
[1]> 4
```

```
Netmask (Ex: "255.255.255.0" or "0xffffffff"):
```

```
[255.255.255.0]>
```

```
Hostname:
```



```
[ ]> v.example.com
```

Currently configured interfaces:

1. Management (10.10.1.10/24 on Management: example.com)
2. P1 (10.10.0.10 on P1: example.com)
3. VLAN 34 (10.10.31.10 on VLAN 34: v.example.com)

Choose the operation you want to perform:

- NEW - Create a new interface.
- EDIT - Modify an interface.
- DELETE - Remove an interface.

```
[ ]>
```

```
example.com> commit
```

## Configuring Transparent Redirection

When you configure the Web Security appliance web proxy service in transparent mode, you must connect the appliance to an Layer 4 switch or a WCCP v2 router, and you must configure the appliance so it knows to which device it is connected. You configure the device on the Network > Transparent Redirection page.

**Figure 25-3** Network > Transparent Redirection Page

### Transparent Redirection

Transparent Redirection Device				
Type: WCCP v2 Router				
<a href="#">Edit Device...</a>				
WCCP v2 Services				
<a href="#">Add Service...</a>				
Service Profile Name	Service ID	Router IP Addresses	Ports	Delete
webcache	0 (web-cache)	10.1.1.1, 100.11.11.11, 111.111.111.111, 101.1.1.1	80	
return_web	99	10.1.1.1, 100.11.11.11, 111.111.111.111, 101.1.1.1	80,443	

On this page, you can choose the device that transparently redirects traffic to the appliance, either an Layer 4 switch or a WCCP router. When you choose an Layer 4 switch as the device, there is nothing else to configure on this page.

However, when you choose a WCCP router as the device, you must create at least one WCCP service.

## Working with WCCP Services

A WCCP service is an appliance configuration that defines a service group to a WCCP v2 router. It includes information such as the service ID and ports used. Service groups allow a web proxy to establish connectivity with a WCCP router and to handle redirected traffic from the router.

You can create WCCP services that use the following service types:

- **Standard service.** The standard service is also known as a well known service because the characteristics of it are known by both WCCP routers and the appliance. It redirects traffic on port 80. It is identified as the “web-cache” service.
- **Dynamic service.** Dynamic services are any other service a web proxy creates, but the web proxy must describe the components of the service group to the router. AsyncOS supports the creation of any dynamic service you choose to define. To create a dynamic service, you must provide the service ID number, port numbers, and specify whether to redirect packets based on the destination or source port and whether to distribute packets based on the client or server address.

The Web Cache Communication Protocol allows 257 different service IDs. AsyncOS allows you to create a dynamic WCCP service for each possible service ID. However, in typical usage, most users create one or two WCCP services, where one is a standard service and the other a dynamic service.

When you create a WCCP service of any type, you must also specify the following information:

- **Assignment method.** For more information, see [Working with the Assignment Method, page 25-12](#).
- **Forwarding and Return method.** For more information, see [Working with the Forwarding and Return Method, page 25-13](#).

If you enable IP spoofing on the appliance, you must create two WCCP services. For more information, see [IP Spoofing when Using WCCP, page 25-13](#).

## Working with the Assignment Method

WCCP defines the assignment method as the method by which redirected packets are distributed between web proxies. In this case, between one or more Web Security appliances. The assignment method determines how the router performs load balancing of packets among multiple Web Security appliances.

You configure the assignment method for a WCCP service in the Load-Balancing Method field under the Advanced section when you create or edit a WCCP service.

You can configure WCCP services to use either of the following assignment methods:

- **Allow Hash Only.** This method relies on a hash function to make redirection decisions. You might want to use Hash when the WCCP router does not support masking.
- **Allow Mask Only.** This method relies on masking to make redirection decisions. WCCP routers make decisions using hardware in the router. This method can be very efficient because the hardware redirects the packets. You might want to choose mask to reduce CPU cycles on the router which can increase router performance. You can only use mask with WCCP routers that support mask assignment.
- **Allow Hash or Mask.** You can also configure a WCCP service to allow either mask or hash load balancing. When a WCCP service allows both mask and hash, AsyncOS communicates with the router to determine whether or not the router supports mask. If the router supports mask, then AsyncOS uses masking in the service group, if the router does not support mask, then AsyncOS uses hashing in the service group.

If you select Allow Mask Only or Allow Hash or Mask, you can customize the mask or specify the number of bits:

- **Custom mask (max 5 bits).** You can specify the mask. The web interface displays the number of bits associated with the mask you provide.
- **System generated mask.** You can let the system generate a mask for you. Optionally, you can specify the number of bits for the system-generated mask, up to 5 bits.

## Working with the Forwarding and Return Method

WCCP defines the forwarding method as the method by which redirected packets are transported from the router to the web proxy. Conversely, the return method redirects packets from the web proxy to the router.

You configure the forwarding and return methods for a WCCP service in the Forwarding Method and Return Method fields under the Advanced section when you create or edit a WCCP service.

You can configure WCCP services to use either of the following methods:

- **Layer 2 (L2).** This method redirects traffic at layer 2 by replacing the packet's destination MAC address with the MAC address of the target web proxy. This method requires that the target web proxy be directly connected to the router at layer 2. WCCP routers only allow L2 negotiation when the appliance is directly connected to the router at layer 2. The L2 method redirects traffic at the router hardware level, and typically has better performance than Generic Routing Encapsulation (GRE). You might want to choose L2 when the router is directly connected to the appliance and you want the performance improvement provided by the L2 method. You can only use the L2 method with WCCP routers that support L2 forwarding.
- **Generic Routing Encapsulation (GRE).** This method redirects traffic at layer 3 by encapsulating the IP packet with a GRE header and a redirect header. This method redirects traffic at the router software level, which can impact performance. You might want to choose GRE when the appliance is not directly connected to the router.

You can also configure a WCCP service to allow either the L2 or GRE methods. When a WCCP service allows both L2 and GRE, the appliance uses the method that the router says it supports. If both the router and appliance support L2 and GRE, the appliance uses L2.



**Note**

---

If the router is not directly connected to the appliance, you must choose GRE.

---

## IP Spoofing when Using WCCP

You can configure the Web Proxy to do IP spoofing. When enabled, requests originating from a client retain the client's source address and appear to originate from the client instead of the Web Proxy.

When you enable IP spoofing, you must create two WCCP services. One WCCP service must redirect traffic based on the destination port, and another based on the source port for the return path. The service based on the destination port can be the standard web-cache service. However, you must still create at least one dynamic service.

The two WCCP services you define for IP spoofing must have the same values for the following settings:

- Port numbers
- Router IP addresses

- Router security and password

**Note**

Cisco suggests using a service ID number from 90 to 97 for the WCCP service used for the return path (based on the source port).

For more information about creating WCCP services, see [Adding and Editing a WCCP Service, page 25-14](#).

## Adding and Editing a WCCP Service

You must create at least one WCCP service when you configure the transparent redirection device as a WCCP router. If IP spoofing is enabled on the appliance, you must create two WCCP services. For more information about IP spoofing, see [IP Spoofing when Using WCCP, page 25-13](#).

- Step 1** Navigate to the Network > Transparent Redirection page.
- Step 2** Verify the transparent redirection device is a WCCP v2 router. If it is not, click **Edit Device** to change it.
- Step 3** To add a WCCP service, click **Add Service**. Or, to edit a WCCP service, click the name of the WCCP service in the Service Profile Name column.
- Step 4** Configure the WCCP options.

[Table 25-3](#) describes the WCCP options.

**Table 25-3** WCCP Service Options

WCCP Service Option	Description
Service Profile Name	Enter a name for the WCCP service.
Service	<p>Use this section to describe the service group for the router.</p> <p>Choose to create either a standard (“well known”) or dynamic service group.</p> <p>If you create a dynamic service, enter the following information:</p> <ul style="list-style-type: none"> <li>• <b>Service ID.</b> Enter any number from 0 to 255 in the Dynamic Service ID field.</li> <li>• <b>Port number(s).</b> Enter up to eight port numbers for traffic to redirect in the Port Numbers field.</li> <li>• <b>Redirection basis.</b> Choose to redirect traffic based on the source or destination port. Default is destination port.</li> <li>• <b>Load balancing basis.</b> When the network uses multiple Web Security appliances, you can choose how to distribute packets among the appliances. You can distribute packets based on the server or client address. When you choose client address, packets from a client always get distributed to the same appliance. Default is server address.</li> </ul> <p>For more information about well known and dynamic service groups, see <a href="#">Working with WCCP Services, page 25-12</a>.</p>
Router IP Addresses	Enter the IP address for one or more WCCP enabled routers. You can enter up to 32 routers to the service group. You must enter the IP address of each router. You cannot enter a multicast address.

Table 25-3 WCCP Service Options (continued)

WCCP Service Option	Description
Router Security	<p>Choose whether or not to require a password for this service group. If required, enter the password in the password fields. The password can contain up to seven characters.</p> <p>When you enable security for a service group, every appliance and WCCP router that uses the service group must use the same password.</p> <p>Requiring a password enables you to control which routers and WCCP-enabled systems, such as the Web Security appliance, become part of the service group.</p> <p>WCCP uses the MD5 hash protocol to encrypt the password.</p> <p><b>Note</b> Each appliance or WCCP router in the service group authenticates the security component in a received WCCP packet immediately after validating the WCCP message header. Packets failing authentication are discarded.</p>
Advanced	<p>Configure the following fields:</p> <ul style="list-style-type: none"> <li>• <b>Load-Balancing Method.</b> This is also known as the assignment method. Choose Mask, Hash, or both. Default is both. For more information about load-balancing, see <a href="#">Working with the Assignment Method, page 25-12</a>.</li> <li>• <b>Forwarding Method.</b> Choose L2, GRE, or both. Default is both. For more information about the forwarding method, see <a href="#">Working with the Forwarding and Return Method, page 25-13</a>.</li> <li>• <b>Return Method.</b> Choose L2, GRE, or both. Default is both. For more information about the return method, see <a href="#">Working with the Forwarding and Return Method, page 25-13</a>.</li> </ul>

**Step 5** Submit and commit your changes.

## Deleting a WCCP Service

- 
- Step 1** Navigate to the Network > Transparent Redirection page.
- Step 2** Click the icon in the Delete column for the WCCP service you want to delete.
- Step 3** Commit your changes.
-

# Configuring SMTP Relay Hosts

AsyncOS periodically sends system-generated email messages, such as notifications, alerts, and Cisco IronPort Customer Support requests. By default, AsyncOS uses information listed in the MX record on your domain to send email. However, if the appliance cannot directly reach the mail servers listed in the MX record, you must configure at least one SMTP relay host on the appliance.

You might want to configure an SMTP relay host in the following scenarios:

- You want the system-generated emails to go to a non-local email address, and port 25 is blocked to outside networks.
- Your mail servers do not allow direct port 25 traffic from internal hosts.

If no SMTP relay host is defined, AsyncOS delivers directly to the mail server for each email address.



## Note

If the Web Security appliance cannot communicate with the mail servers listed in the MX record or any of the configured SMTP relay hosts, it cannot send email messages and it writes a message in the log files.

You can configure one or more SMTP relay hosts. You might want to configure multiple SMTP relay hosts for redundancy in case one system becomes unavailable. When you configure multiple SMTP relay hosts, AsyncOS uses the topmost available SMTP relay host. If an SMTP relay host is unavailable, it tries to use the one below it in the list.

You can configure the SMTP relay host from either the web interface or command line interface:

- **Web interface.** Use the Network > Internal SMTP Relay page.
- **Command line interface.** Use the `smtprelay` CLI command.

## Configuring SMTP from the Web Interface

**Step 1** Navigate to the Network > Internal SMTP Relay page.

**Step 2** Click **Edit Settings**.

**Step 3** Enter the information listed in [Table 25-4](#).

**Table 25-4 SMTP Relay Host Settings**

Property	Description
Relay Hostname or IP Address	Enter the hostname or IP address to use for the SMTP relay
Port	Enter the port for connecting to the SMTP relay. If this property is empty, the appliance uses port 25. This property is optional.
Routing Table to Use for SMTP	Choose the routing table associated with an appliance network interface, either Management or Data, to use for connecting to the SMTP relay. Choose whichever interface is on the same network as the relay system.

**Step 4** Optionally, you can add more SMTP relay host information by clicking **Add Row**.

**Step 5** Submit and commit your changes.

---

## Configuring SMTP from the CLI

Use the `smtprelay` command to configure SMTP relay hosts.

For example:

```
example.com> smtprelay
```

```
No internal SMTP relay host configured.
```

```
Choose the operation you want to perform:
```

```
- NEW - Add a new host.
```

```
[ ]> new
```

```
Please enter the hostname of your relay host. You may put a colon after the hostname to indicate a port to use other than 25, such as "smtp.example.com:547".
```

## Configuring DNS Server(s)

You can configure the DNS settings for your appliance using the `Network > DNS` page or using the `dnsconfig` command. Before you configure DNS, consider the following:

- Whether to use the Internet's DNS servers or your own, and which specific server(s) to use.
- Which routing table to use for DNS traffic.

You must use the routing table associated with the interface that faces the DNS server, either Data or Management.

- The number of seconds to wait before timing out a reverse DNS lookup.
- Clearing the DNS cache.

## Specifying DNS Servers

AsyncOS for Web can use the Internet root DNS servers or your own DNS servers. When using the Internet root servers, you can specify alternate servers to use for specific domains. Since an alternate DNS server applies to a single domain, it must be authoritative (provide definitive DNS records) for that domain.

## Split DNS

AsyncOS supports split DNS where internal servers are configured for specific domains and external or root DNS servers are configured for other domains. If you are using your own internal server, you can also specify exception domains and associated DNS servers.

## Using the Internet Root Servers

The AsyncOS DNS resolver is designed to accommodate the large number of simultaneous DNS connections.

## Multiple Entries and Priority

For each DNS server you enter, you can specify a numeric priority. AsyncOS will attempt to use the DNS server with the priority closest to 0. If that DNS server is not responding AsyncOS will attempt to use the server at the next priority. If you specify multiple entries for DNS servers with the same priority, the system randomizes the list of DNS servers at that priority every time it performs a query. The system then waits a short amount of time for the first query to expire or “time out” and then increments with a slightly longer amount of time for subsequent servers. The amount of time depends on the exact number of DNS servers and priorities that have been configured. The timeout length is the same for all IP addresses at any particular priority. The first priority gets the shortest timeout, each subsequent priority gets a longer timeout. Further, the timeout period is roughly 60 seconds. If you have one priority, the timeout for each server at that priority is 60 seconds. If you have two priorities, the timeout for each server at the first priority is 15 seconds, and each server at the second priority is 45 seconds. For three priorities, the timeout increments are 5, 10, 45.

For example, four DNS servers with two configured at priority 0, one at priority 1, and one at priority 2:

**Table 25-5 Example of DNS Servers, Priorities, and Timeout Intervals**

Priority	Server(s)	Timeout (seconds)
0	1.2.3.4, 1.2.3.5	5, 5
1	1.2.3.6	10
2	1.2.3.7	45

AsyncOS randomly chooses between the two servers at priority 0. If one of the priority 0 servers is down, the other is used. If both priority 0 servers are down, the priority 1 server (1.2.3.6) is used, and finally, the priority 2 (1.2.3.7) server.

The timeout period is the same for both priority 0 servers, longer for the priority 1 server, and longer still for the priority 2 server.

## DNS Alert

If an alert with the message “Failed to bootstrap the DNS cache” is generated when an appliance is rebooted, it means that the system was unable to contact its primary DNS servers. This can happen at boot time if the DNS subsystem comes online before network connectivity is established. If this message appears at other times, it could indicate network issues or that the DNS configuration is not pointing to a valid server.

## Clearing the DNS Cache

You can use the Clear DNS Cache button on Network > DNS page, or the `dnsflush` command to clear all information in the DNS cache when changes have been made to your local DNS system. Using this command might cause a temporary performance degradation while the cache is repopulated.



## Editing DNS Settings

---

- Step 1** Navigate to the Network > DNS page.
- Step 2** Click **Edit Settings**.
- Step 3** Select to use the Internet's root DNS servers or your own internal DNS server or the Internet's root DNS servers and specify authoritative DNS servers.
- Step 4** If you use your own DNS server(s), or specify authoritative DNS servers, enter the server ID, specify a priority, and use the Add Row key to repeat as necessary for each server.
- Step 5** Choose the routing table associated with an appliance network interface type, either Management or Data, to use for DNS traffic.
- Step 6** Enter the number of seconds to wait before cancelling a reverse DNS lookup.
- Step 7** In the Domain Search List, enter zero or more domain suffixes to append to hostnames before AsyncOS does a DNS match.
- The DNS domain search list is used when a request does not resolve with the DNS server. The domains specified are each attempted in turn to see if a DNS match for the hostname plus domain can be found. The list is searched in order (from left to right) until a match is found.
- Step 8** Submit and commit to save the changes.
-



# 26

## System Administration

---

- [Managing the S-Series Appliance, page 26-1](#)
- [Support Commands, page 26-2](#)
- [Working with Feature Keys, page 26-6](#)
- [Cisco Web Security Virtual Appliance License, page 26-8](#)
- [Administering User Accounts, page 26-8](#)
- [Defining User Preferences, page 26-14](#)
- [Configuring Administrator Settings, page 26-15](#)
- [Configuring the Return Address for Generated Messages, page 26-16](#)
- [Managing Alerts, page 26-17](#)
- [FIPS Compliance, page 26-27](#)
- [System Date and Time Management, page 26-28](#)
- [Installing a Server Digital Certificate, page 26-30](#)
- [Upgrading AsyncOS for Web, page 26-34](#)
- [Configuring Upgrade and Service Update Settings, page 26-36](#)
- [Reverting to a Previous Version of AsyncOS for Web, page 26-41](#)

## Managing the S-Series Appliance

The S-Series appliance provides a variety of tools for managing the system. Functionality on System Administration tab helps you manage the following tasks:

- Appliance configuration
- Feature keys
- Adding, editing, and removing user accounts
- AsyncOS software upgrades
- Updates to security components
- System time

## Saving and Loading the Appliance Configuration

All configuration settings within the Web Security appliance can be managed using a single configuration file. The file is maintained in XML (Extensible Markup Language) format.

To archive the current configuration, you can use the System Administration > Configuration Summary page to print a summary of appliance settings, and you can use the System Administration > Configuration File page to create a local copy of the system configuration file. The system configuration file can be used to import a complete configuration or to load a unique sub-section and update specific settings.

When you save the configuration file, you can choose a system-generated name or define your own file name. You can mask the user's passwords by clicking a checkbox. Masking a password causes the original, encrypted password to be replaced with "\*\*\*\*\*" in the exported or saved file. Please note, however, that configuration files with masked passwords cannot be loaded back into AsyncOS for Web.

Use the Load Configuration section of the System Administration > Configuration File page to load new configuration information into the Web Security appliance. You can load information using any of the following methods:

- Place information in the `configuration` directory and upload it.
- Upload the configuration file directly from your local machine.
- Paste configuration information directly into the web interface.

To load a copy of the configuration file, paste the configuration directly into the web interface page. At the top of the configuration file you must include the following tag:

```
<?xml version="1.0" encoding="ISO-8859-1"?> <!DOCTYPE config SYSTEM "config.dtd">
<config> ... your configuration information in valid XML </config>
```

After loading the XML sub-section, submit and commit the update.

If a compatible configuration file is based on an older version of the set of URL categories than the version currently installed on the appliance, policies and identities in the configuration file may be modified automatically. For information, see [Managing Updates to the Set of URL Categories, page 17-4](#).

## Committing Changes to the Appliance Configuration

Each time you modify settings and change appliance behavior using the S-Series web interface, you must first submit your changes and then commit them to the active configuration.

For more information about committing changes, see [Committing and Clearing Changes, page 2-9](#).

## Support Commands

The features in this section are useful when you upgrade the appliance or contact your support provider. You can find the following commands under the Technical Support section of the Support and Help menu:

- **Open a Support Case.** For more information, see [Opening a Support Case, page 26-3](#).
- **Remote Access.** For more information, see [Remote Access, page 26-3](#).
- **Packet Capture.** For more information, see [Packet Capture, page 26-4](#).

## Opening a Support Case

You can use the appliance to send an email to Cisco IronPort Customer Support asking for assistance. When the appliance sends the email, it also sends the configuration of the appliance. You can do this in the following ways:

- **CLI.** Use the `supportrequest` command.
- **Web interface.** Use the Support and Help menu > Open a Support Case page.

When you send a support request, you can enter comments describing the issue for which you need support. The appliance must be able to send mail to the Internet to send a support request.

- 
- Step 1** From the Support and Help menu, choose Open a Support Case.
- Step 2** In the Other Recipients field, enter other email addresses separated by commas if you want to send this support request to other people.
- By default, the support request (including the configuration file) is sent to Cisco IronPort Customer Support (via the checkbox at the top of the form).
- Step 3** Enter your contact information, such as name and email.
- Step 4** From the Issue Priority field, select the priority of this support request.
- Step 5** In the Issue Subject field, enter the text to use in the subject line of the email that will be sent.
- Step 6** In the Issue Description field, enter a description of the issue.
- Step 7** If you have a customer support ticket already for this issue, enter it.
- Step 8** Click **Send**. A trouble ticket is created with Cisco.
- 

For additional information, see [Customer Support, page 1-9](#).

## Remote Access

Use the Support and Help menu > Remote Access page to allow Cisco IronPort Customer Support remote access to the Web Security appliance. Click **Edit Remote Access Settings** to allow Cisco IronPort Customer Support to access the appliance.

**Figure 26-1 Remote Access Page**

### Edit Customer Support Remote Access

Customer Support Remote Access	
<input checked="" type="checkbox"/> Allow remote access to this appliance	
Customer Support Password:	<input type="password"/> <small>Cannot be the same as your admin password</small>
Secure Tunnel (recommended):	<input checked="" type="checkbox"/> Initiate connection via secure tunnel Port: <input type="text" value="443"/>
Appliance Serial Number:	00000000

By enabling Remote Access you are activating a special account used by Cisco IronPort Customer Support for debugging and general access to the system. This is used by Cisco IronPort Customer Support for tasks such as assisting customers in configuring their systems, understanding configurations, and investigating problem reports. You can also use the `techsupport` command in the CLI.

When enabling the “Secure Tunnel,” the appliance creates an SSH tunnel over the specified port to the server `upgrades.ironport.com`. By default this connection is over port 443, which will work in most environments. Once a connection is made to `upgrades.ironport.com`, Cisco IronPort Customer Support is able to use the SSH tunnel to obtain access to the appliance. As long as the connection over port 443 is allowed, this will bypass most firewall restrictions. You can also use the `techsupport tunnel` command in the CLI.

In both the “Remote Access” and “Tunnel” modes, a password is required. It is important to understand that this is *not* the password that will be used to access the system. Once that password and the system serial number (physical appliance) or VLN (virtual appliance) are provided to your Customer Support representative, a password used to access the appliance is generated.

Once the `techsupport tunnel` is enabled, it will remain connected to `upgrades.ironport.com` for 7 days. After 7 days, no new connections can be made using the `techsupport tunnel`. If there are any existing connections using the tunnel after 7 days, those connections will continue to exist and work. However, once those connections are closed, they will not be able to open again because the `techsupport tunnel` will have closed after 7 days. The timeout set on the SSH tunnel connection does not apply to the Remote Access account; it will remain active until specifically deactivated.

## Packet Capture

Sometimes when you contact Cisco IronPort Customer Support with an issue, you may be asked to provide insight into the network activity going into and out of the Web Security appliance. The appliance provides the ability to intercept and display TCP/IP and other packets being transmitted or received over the network to which the appliance is attached.

You might want to run a packet capture to debug the network setup and to discover what network traffic is reaching the appliance or leaving the appliance.

### Packet Capture

The screenshot displays the Packet Capture web interface with three main sections:

- Current Packet Capture:** Shows "No packet capture in progress" and a "Start Capture" button.
- Manage Packet Capture Files:** A list of captured files:
  - `$10-005056040101-vmware-20080428-131029.cap (24B)`
  - `$10-005056040101-vmware-20080428-130812.cap (58K)`
  - `$10-005056040101-vmware-20080428-130537.cap (13K)`
  - `$10-005056040101-vmware-20080428-125425.cap (24B)`
 Below the list are "Delete Selected Files" and "Download File" buttons.
- Packet Capture Settings:** A table of configuration options:
 

Capture File Size Limit:	200 MB
Capture Duration:	Run Capture Indefinitely
Interfaces Selected:	Management
Filters Selected:	(top port 80 or top port 3128)

 An "Edit Settings..." button is located at the bottom right of this section.

The appliance saves the captured packet activity to a file and stores the file locally. You can configure the maximum packet capture file size, how long to run the packet capture, and on which network interface to run the capture. You can also use a filter to limit the number of packets seen by the packet capture which can make the output more usable on networks with a high volume of traffic. You can send any stored packet capture file using FTP to Cisco IronPort Customer Support for debugging and troubleshooting purposes.

The Support and Help > Packet Capture page displays the list of complete packet capture files stored on the hard drive. When a packet capture is running, the web interface shows the status of the capture in progress by showing the current statistics, such as file size and time elapsed.

You can download the packet capture files using the **Download** button in the web interface, or by connecting to the appliance using FTP and retrieving them from the captures directory.

In the CLI, use the `packetcapture` command.

In the web interface, select the Packet Capture option under the Support and Help menu.

**Note**

The packet capture feature is similar to the Unix `tcpdump` command.

## Starting a Packet Capture

To start a packet capture in the CLI, run the `packetcapture > start` command. If you need to stop a running packet capture, run the `packetcapture > stop` command.

To start a packet capture in the web interface, select the Packet Capture option under the Support and Help menu, and then click **Start Capture**. To stop a running capture, click **Stop Capture**.

**Note**

The web interface only displays packet captures started in the web interface, not from the CLI. Similarly, the CLI only displays the status of a current packet capture run started in the CLI.

## Editing Packet Capture Settings

To edit the packet capture settings in the CLI, run the `packetcapture > setup` command.

To edit packet capture settings in the web interface, select the Packet Capture option under the Support and Help menu, and then click **Edit Settings**.

Table 26-1 describes the packet capture settings you can configure.

**Table 26-1** Packet Capture Configuration Options

Option	Description
Capture file size limit	The maximum file size for all packet capture files.
Capture duration	<p>Choose how long to run the packet capture:</p> <ul style="list-style-type: none"> <li>• <b>Run Capture Until File Size Limit Reached.</b> The packet capture runs until the file size limit is reached.</li> <li>• <b>Run Capture Until Time Elapsed Reaches.</b> The packet capture runs until the configured time has passed. You can enter the time in seconds (s), minutes (m), or hours (h). If you enter the amount of time without specifying the units, AsyncOS uses seconds by default. <b>Note:</b> If the file reaches the maximum size limit before the entire time has elapsed, the existing file is deleted (the data is discarded) and a new file starts with the current packet capture data.</li> <li>• <b>Run Capture Indefinitely.</b> The packet capture runs until you manually stop it. <b>Note:</b> If the file reaches the maximum size limit before you manually stop the packet capture, the existing file is deleted (the data is discarded) and a new file starts with the current packet capture data.</li> </ul> <p>You can always manually stop any packet capture.</p>

**Table 26-1 Packet Capture Configuration Options (continued)**

Option	Description
Network interface to capture	Select the network interface on which to run the packet capture.
Filters	Choose whether or not to apply a filter to the packet capture to reduce the amount of data stored in the packet capture.  You can use one of the predefined filters to filter by port, source IP address, or destination IP address, or you can create a custom filter using any syntax supported by the Unix tcpdump command.

**Note**

When you change the packet capture settings without committing the changes and then start a packet capture, AsyncOS uses the new settings. This allows you to use the new settings in the current session without enforcing the settings for future packet capture runs. The settings remain in effect until you clear them.

Figure 26-2 on page 26-6 shows where you can edit the packet capture settings in the web interface.

**Figure 26-2 Editing Packet Capture Settings in the Web Interface****Edit Packet Capture Settings**

Packet Capture Settings

Capture File Size Limit:  MB Maximum file size is 200MB

Capture Duration:

Run Capture Until File Size Limit Reached

Run Capture Until Time Elapsed Reaches  (e.g. 120s, 5m 30s, 4h)

Run Capture Indefinitely

The capture can be ended manually at any time; use the settings above to specify whether the capture should end automatically.

Interfaces:

Management

T1

T2

Packet Capture Filters

Filters: All filters are optional. Fields are not mandatory.

No Filters

Predefined Filters

Ports:

Source IP:

Destination IP:

Custom Filter ?

## Working with Feature Keys

Occasionally, your support team may provide a key to enable specific functionality on your system. Use the System Administration > Feature Keys page in the web interface (or the `featurekey` command in the CLI) to enter the key and enable the associated functionality.



Keys are specific to the serial number of your appliance and specific to the feature being enabled (you cannot re-use a key from one system on another system). If you incorrectly enter a key, an error message is generated.

Feature keys functionality is split into two pages: Feature Keys and Feature Key Settings.

**Note**

Feature keys for the Web Security Virtual appliance are included in the virtual appliance license file and cannot be installed separately. See [Cisco Web Security Virtual Appliance License, page 26-8](#) for more information.

## Feature Keys Page

The Feature Keys page:

- Lists all active feature keys for the appliance.
- Shows any feature keys that are pending activation.
- Looks for new keys that have been issued (optional, and also can install keys).

A list of the currently enabled features is displayed. The Pending Activation section is a list of feature keys that have been issued for the appliance but have not yet been activated. Your appliance may check periodically for new keys depending on your configuration. You can click **Check for New Keys** to refresh the list of pending keys.

**Figure 26-3**     *The Feature Keys Page*

### Feature Keys

Feature Keys for Serial Number: 005056AA3938-vmware			
Description	Status	Time Remaining	Expiration Date
IronPort L4 Traffic Monitor	Active	29 days	Sat Jul 24 02:52:49 2010
IronPort HTTPS Proxy	Active	29 days	Sat Jul 24 03:05:17 2010
Cisco IronPort Web Usage Controls	Active	29 days	Sat Jul 24 02:52:49 2010
Sophos	Active	29 days	Sat Jul 24 02:52:49 2010
IronPort URL Filtering	Active	30 days	Dormant
McAfee	Active	29 days	Sat Jul 24 02:52:49 2010
Webroot	Active	29 days	Sat Jul 24 02:52:49 2010
IronPort Web Proxy & DVS™ Engine	Active	29 days	Sat Jul 24 02:52:49 2010
Cisco Mobile User Security	Active	29 days	Sat Jul 24 03:06:32 2010
IronPort Web Reputation Filters	Active	29 days	Sat Jul 24 02:52:49 2010
Pending Activation			
No feature key activations are pending.			
			<a href="#">Check for New Keys</a>

Feature Activation	
Feature Key:	<input type="text"/>
<a href="#">Submit Key</a>	

You can also use the `featurekey` CLI command to accomplish the same tasks as on the Feature Keys page.

## Feature Key Settings Page

The Feature Key Settings page is used to control whether your appliance checks for and downloads new feature keys, and whether or not those keys are automatically activated.

**Figure 26-4** The Feature Key Settings Page**Feature Key Settings**

Feature Key Settings	
Automatically Check For New Feature Keys:	Enabled (Last download attempt made on: 22 Apr 2008 20:13 (GMT))
Automatically Apply Downloaded Feature Keys:	Enabled
<a href="#">Edit Feature Key Settings...</a>	

To add a new feature key manually, paste or type the key into the Feature Key field and click **Submit Key**. An error message is displayed if the feature is not added (if the key is incorrect, etc.), otherwise the feature key is added to the display.

To activate a new feature key from the Pending Activation list, select the key (mark the “Select” checkbox) and click **Activate Selected Keys**.

You can configure your appliance to automatically download and install new keys as they are issued. In this case, the Pending Activation list will always be empty. You can tell AsyncOS to look for new keys at any time by clicking the **Check for New Keys** button, even if you have disabled the automatic checking via the Feature Key Settings page.

You can also use the `featurekeyconfig` CLI command to accomplish the same tasks as on the Feature Key Settings page.

## Expired Feature Keys

If the feature key for the feature you are trying to access (via the web interface) has expired, please contact your Cisco representative or support organization.

## Cisco Web Security Virtual Appliance License

The Cisco Web Security Virtual appliance requires an additional license to run the virtual appliance on a host. You can use this license for multiple, cloned virtual appliances.

To install this license, run the `loadlicense` CLI command. You can either copy and paste the license into the CLI or upload it onto the appliance’s `configuration` directory using FTP before running the command. It must be installed on the appliance before running the System Setup Wizard.

Feature keys are included as part of the virtual appliance license. The feature keys expire at the same time as the license, even if the key has not been activated yet. Purchasing new feature keys will require downloading and installing a new virtual appliance license.

Due to feature keys being included in the virtual appliance license, there are no 30-day evaluations for AsyncOS for Web features.

**Note**

You cannot open a Technical Support tunnel before installing the virtual appliance license.

See the *Cisco Security Virtual Appliance Installation Guide* for more information on setting up and running the Web Security Virtual appliance.

## Administering User Accounts

The following types of users can log into the Web Security appliance to manage the appliance:

- **Local users.** You can define users locally on the appliance itself. For more information, see [Managing Local Users, page 26-9](#).
- **Users defined in an external system.** You can configure the appliance to connect to an external RADIUS server to authenticate users logging into the appliance. For information, see [RADIUS User Authentication, page 26-12](#).

You can manage local users and connections to external authentication servers using the System Administration > Users page in the web interface, or the `userconfig` command in the CLI.

Figure 26-5 shows where you manage local users and external authentication.

**Figure 26-5** System Administration > Users Page

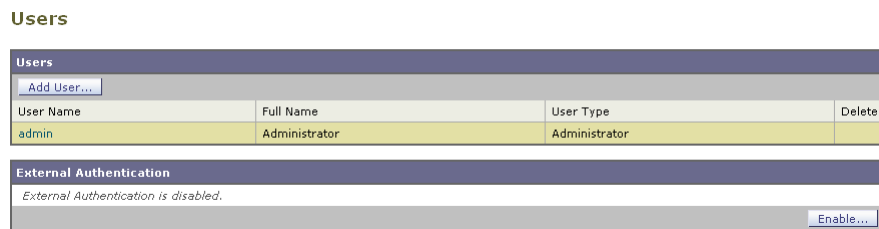

**Note**

Any user you define can log into the appliance using any method, such as logging into the web interface or using SSH.

## Managing Local Users

You can define any number users locally on the Web Security appliance. You can add, edit, and delete local users. Consider the following rules when defining local users:

- User names can contain lowercase letters, numbers, and the dash ( - ) character.
- User names cannot start with a dash.
- User names cannot be greater than 16 characters.
- Passwords must contain at least 6 characters.
- User names cannot be special names that are reserved by the system, such as “operator” or “root.”
- If you also use external authentication, user names should not duplicate externally-authenticated user names.



**Note**

You can define different preferences, such as language support, for local users. For more information, see [Defining User Preferences, page 26-14](#).

The default system admin account has all administrative privileges. You can change the admin account password, but you cannot edit or delete this account.

To create a new user account, specify a user name and a full name, and then assign the user to a user role type. Each user type provides a different level of default permissions. Table 26-2 lists the user types you can assign.

**Table 26-2**      **User Types**

Group	Description
Administrator	Allows full access to all system configuration settings. However, the <code>upgradecheck</code> and <code>upgradeinstall</code> commands can be issued only from the system defined “admin” account.
Operator	Restricts users from creating, editing, or removing user accounts. The operators group also restricts the use of the following commands: <ul style="list-style-type: none"> <li>• <code>resetconfig</code></li> <li>• <code>upgradecheck</code></li> <li>• <code>upgradeinstall</code></li> <li>• <code>systemsetup</code> or running the System Setup Wizard</li> </ul>
Read-Only Operator	User accounts with this role: <ul style="list-style-type: none"> <li>• Can view configuration information.</li> <li>• Can make and submit changes to see how to configure a feature, but they cannot commit them.</li> <li>• Cannot make any other changes to the appliance, such as clearing the cache or saving files.</li> <li>• Cannot access the file system, FTP, or SCP.</li> </ul>
Guest	The guests group users can only view system status information.

After assigning the user to a group, you must specify a password for the new account.



**Note**

If you have lost the admin user password, contact your support provider.

## Adding Local Users

- 
- Step 1** On the System Administration > Users page, click **Add User**.
  - Step 2** Enter a name for the user. Some words are reserved, such as “operator” and “root”.
  - Step 3** Enter a full name for the user.
  - Step 4** Select a user type. See Table 26-2, ‘User Types,’ on page 10 for more information about user types.
  - Step 5** Enter a password and retype it.
  - Step 6** Submit and commit your changes.
-

## Deleting Users

- 
- Step 1** On the System Administration > Users page, click the trash can icon corresponding to the listed user name.
  - Step 2** Confirm the deletion by clicking **Delete** in the warning dialog that appears.
  - Step 3** Submit and commit your changes.
- 

## Editing Users

- 
- Step 1** On the System Administration > Users page, click the user name.
  - Step 2** Make changes to the user on the Edit User page.
  - Step 3** Submit and commit your changes.
- 

## Changing Passwords

Users can change their own passwords using the Change Password option under the Options menu located on the top right-hand side of the web interface.

Figure 26-6 shows where you can change the current user password.

**Figure 26-6** The Change Password Option

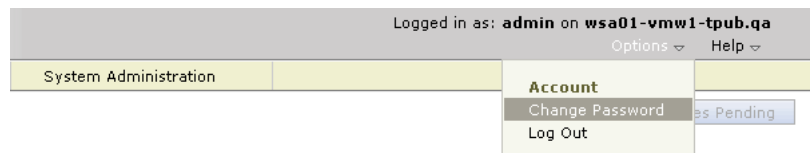

### Note

To change the password for the admin account, use the System Administration > Users page or use the `password` or `passwd` command in the CLI. Password changes take effect immediately and do not require a commit.

## Monitoring Users from the CLI

The `who`, `whoami`, and `last` commands can be used to monitor user access to the appliance.

- The `who` command lists users, the time of login, idle time, and the remote host from which the user is logged in:

```
example.com> who
```

```
Username Login Time Idle Time Remote Host What
```

```

=====
admin      03:27PM      0s          10.xx.xx.xx  cli

```

- The `whoami` command displays the user name and group information:

```

example.com> whoami

Username: admin

Full Name: Administrator

Groups: admin, operators, config, log, guest

```

- The `last` command displays information about users who have recently logged into the appliance.

```

example.com> last

Username Remote Host Login Time Logout Time Total Time
=====
admin    10.xx.xx.xx Sat May 15 23:42 still logged in 15m
admin    10.xx.xx.xx Sat May 15 22:52 Sat May 15 23:42 50m
admin    10.xx.xx.xx Sat May 15 11:02 Sat May 15 14:14 3h 12m
admin    10.xx.xx.xx Fri May 14 16:29 Fri May 14 17:43 1h 13m

shutdown                               Fri May 14 16:22

```

## RADIUS User Authentication

You can configure the Web Security appliance to use a RADIUS directory service to authenticate users logging in to the appliance. You can use external authentication when logging into the appliance using HTTP, HTTPS, SSH, and FTP. To set up the appliance to use an external directory for authentication, use the System Administration > Users page in the web interface or the `userconfig > external` CLI command.

You can configure the appliance to contact multiple external servers for authentication. You might want to define multiple external servers to allow for failover in case one server is temporarily unavailable. When you define multiple external servers, the appliance connects to the servers in the order defined on the appliance.

When external authentication is enabled and a user logs into the Web Security appliance, the appliance first determines if the user is the system defined “admin” account. If not, then the appliance checks the first configured external server to determine if the user is defined there. If the appliance cannot connect to the first external server, the appliance checks the next external server in the list. If the appliance cannot connect to any external server, it tries to authenticate the user as a local user defined on the Web Security appliance. If the user does not exist on any external server or on the appliance, or if the user enters the wrong password, access to the appliance is denied.

Consider the following rules and guidelines when using external authentication:

- You can configure up to ten RADIUS servers.
- The appliance can communicate with RADIUS directories using either the Password Authentication Protocol (PAP) or Challenge Handshake Authentication Protocol (CHAP).
- You can map all RADIUS users to the Administrator user role type or you can map RADIUS users to different Web Security appliance user role types.
- If you will also add local users, be sure that local user names do not duplicate externally-authenticated user names.

## Enabling External Authentication Using RADIUS

- 
- Step 1** On the System Administration > Users page, click **Enable**.
- Step 2** Check the **Enable External Authentication** option if it is not enabled already.
- Step 3** Enter the hostname for the RADIUS server.
- Step 4** Enter the port number for the RADIUS server. The default port number is 1812.
- Step 5** Enter the Shared Secret password for the RADIUS server.
- Step 6** Enter the number of seconds for the appliance to wait for a response from the server before timing out.
- Step 7** (Optional) Click **Add Row** to add another RADIUS server. Repeat steps 3–6 for each RADIUS server.



---

**Note** You can add up to ten RADIUS servers.

---

- Step 8** Enter the number of seconds AsyncOS stores the external authentication credentials before contacting the RADIUS server again to re-authenticate in the “External Authentication Cache Timeout” field. Default is zero (0).



---

**Note** If the RADIUS server uses one-time passwords, for example passwords created from a token, enter zero (0). When the value is set to zero, AsyncOS does not contact the RADIUS server again to authenticate during the current session.

---

**Step 9** Configure Group Mapping:

Setting	Description
Map externally authenticated users to multiple local roles.	<p>AsyncOS assigns RADIUS users to appliance roles based on the RADIUS CLASS attribute. CLASS attribute requirements:</p> <ul style="list-style-type: none"> <li>• 3 character minimum</li> <li>• 253 character maximum</li> <li>• no colons, commas, or newline characters</li> <li>• one or more mapped CLASS attributes for each RADIUS user (With this setting, AsyncOS denies access to RADIUS users without a mapped CLASS attribute.)</li> </ul> <p>For RADIUS users with multiple CLASS attributes, AsyncOS assigns the most restrictive role. For example, if a RADIUS user has two CLASS attributes, which are mapped to the Operator and Read-Only Operator roles, AsyncOS assigns the RADIUS user to the Read-Only Operator role, which is more restrictive than the Operator role.</p> <p>These are the appliance roles ordered from least restrictive to most restrictive:</p> <ul style="list-style-type: none"> <li>• Administrator</li> <li>• Operator</li> <li>• Read-Only Operator</li> <li>• Guest</li> </ul>
Map all externally authenticated users to the Administrator role.	AsyncOS assigns RADIUS users to the Administrator role.

**Step 10** Choose whether to map all externally authenticated users to the Administrator role or to different appliance user role types.

**Step 11** If you map users to different role types, enter the group name as defined in the RADIUS CLASS attribute in the Group Name or Directory field, and choose an appliance role type from the Role field. You can add more role mappings by clicking **Add Row**.

For more information on user role types, see [Managing Local Users, page 26-9](#).

**Step 12** Submit and commit your changes.

## Defining User Preferences

Local users can define preference settings, such as language, specific to each account. These settings apply by default when the user first logs into the appliance. The preference settings are stored for each user and are the same regardless from which client machine the user logs into the appliance.

When users change these settings but do not commit the changes, the settings revert to the default values when they log in again.



Table 26-3 describes the user preference settings you can define.

**Table 26-3** *User Preference Settings*

Preference Setting	Description
Language Display	The language AsyncOS for Web uses in the web interface and CLI.
Landing Page	The page that displays when the user logs into the appliance.
Reporting Time Range Displayed (default)	The default time range that displays for reports on the Reporting tab.
Number of Reporting Rows Displayed	The number of rows of data shown for each report by default.

- 
- Step 1** Log into the appliance with the user account for which you want to define its preference settings.
- Step 2** Choose Preferences from the Options menu.
- Step 3** On the User Preferences page, click **Edit Preferences**.
- Step 4** Configure the settings described in [Table 26-3](#).
- Step 5** Submit and commit your changes.
- 

## Configuring Administrator Settings

You can configure the Web Security appliance to have stricter access requirements for administrators logging into the appliance. You might want to do this to meet certain organization requirements.

You configure these settings with the `adminaccessconfig` CLI command. You can configure the appliance to:

- Display user-defined text at administrator login.
- Restrict administrator access to certain machines.
- Require stronger SSL ciphers for administrator access.

### Configuring Custom Text at Login

Using the `adminaccessconfig > banner` CLI command, you can configure the appliance to display any text you specify when an administrator tries to log in. You might want to do this to display a banner that informs the user of organizational policies and conditions. The custom banner text appears when an administrator tries to access the appliance through all interfaces, such as the web interface or via FTP.

You can load the custom text by either pasting it into the CLI prompt or by copying it from a file located on the Web Security appliance. To upload the text from a file, you must first transfer the file to the configuration directory on the appliance using FTP.

## Configuring IP-Based Administrator Access

Using the `adminaccessconfig > ipaccess` CLI command, you can control from which IP addresses administrators access the Web Security appliance. Administrators can access the appliance from any machine or from machines with an IP address from a list you specify.

When restrict access to an allow list, you can specify IP addresses, subnets, or CIDR addresses.

By default, when you list the addresses that can access the appliance, the IP address of your current machine is listed as the first address in the allow list. You cannot delete the IP address of your current machine from the allow list.

## Configuring the SSL Ciphers for Administrator Access

Using the `adminaccessconfig > strictssl` CLI command, you can configure the appliance so administrators log into the web interface on port 8443 using stronger SSL ciphers (greater than 56 bit encryption).

When you configure the appliance to require stronger SSL ciphers, the change only applies to administrators accessing the appliance using HTTPS to manage the appliance. It does not apply to other network traffic connected to the Web Proxy using HTTPS.

## Configuring the Return Address for Generated Messages

You can configure the return address for mail generated by AsyncOS for reports. You can specify the display, user, and domain names of the return address. You can also choose to use the Virtual Gateway domain for the domain name.

Configure the return address on the System Administration > Return Addresses page.

**Figure 26-7** Configuring Return Addresses



- Step 1** Navigate to the System Administration > Return Addresses page.
- Step 2** Click **Edit Settings**.

**Figure 26-8** Editing Return Address Settings

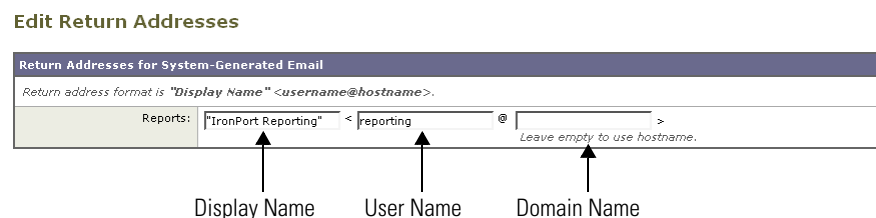

- Step 3** For Reports, enter the display name, user name, and domain name in the fields shown in [Figure 26-8](#).

**Step 4** Submit and commit your changes.

---

## Managing Alerts

Alerts are email notifications containing information about events occurring on the IronPort appliance. These events can be of varying levels of importance (or severity) from minor (Informational) to major (Critical) and pertain generally to a specific component or feature on the appliance. Alerts are generated by the IronPort appliance. You can specify which alert messages are sent to which users and for which severity of event they are sent. Manage alerts using the System Administration > Alerts page in the web interface or using the `alertconfig` command in the CLI.



### Note

To receive alerts and email notifications, you must configure the SMTP relay host that the appliance uses to send the email messages. For information about configuring the SMTP relay host, see [Configuring SMTP Relay Hosts, page 25-16](#).

---

## Alerting Overview

The alerting feature consists of two main parts:

- **Alerts** - consist of an Alert **Recipient** (email addresses for receiving alerts), and the alert notification (severity and alert type) sent to the recipient.
- **Alert Settings** - specify global behavior for the alerting feature, including alert sender (FROM:) address, seconds to wait between sending duplicate alerts, and whether to enable AutoSupport (and optionally send weekly AutoSupport reports).

## Alerts: Alert Recipients, Alert Classifications, and Severities

Alerts are email messages or notifications containing information about a specific function (or alert classification) or functions such as a hardware or anti-virus problem, sent to an alert-recipient. An alert recipient is simply an email address to which the alert notifications are sent. The information contained in the notification is determined by an alert classification and a severity. You can specify which alert classifications, at which severity, are sent to any alert recipient. The alerting engine allows for granular control over which alerts are sent to which alert recipients. For example, you can configure the system to send only specific alerts to an alert recipient, configuring an alert recipient to receive notifications only when Critical (severity) information about the System (alert type) is sent. You can also configure general settings (see [Configuring Alert Settings, page 26-22](#)).

### Alert Classifications

AsyncOS sends the following alert classifications:

**Table 26-4** *Alert Classifications and Components*

Alert Classification	Alert Component
System	System
Hardware	Hardware

**Table 26-4** Alert Classifications and Components (continued)

Alert Classification	Alert Component
Updater	Updater
Web Proxy	Proxy
DVS™ and Anti-Malware	DVS
L4 Traffic Monitor	TrafMon

## Severities

Alerts can be sent for the following severities:

- Critical: Requires immediate attention.
- Warning: Problem or error requiring further monitoring and potentially immediate attention.
- Information: Information generated in the routine functioning of this device.

## Alert Settings

Alert settings control the general behavior and configuration of alerts, including:

- The RFC 2822 Header From: when sending alerts (enter an address or use the default “alert@<hostname>”). You can also set this via the CLI, using the `alertconfig > from` command.
- The initial number of seconds to wait before sending a duplicate alert.
- The maximum number of seconds to wait before sending a duplicate alert.
- The status of AutoSupport (enabled or disabled).
- The sending of AutoSupport’s weekly status reports to alert recipients set to receive System alerts at the Information level.

## Sending Duplicate Alerts

You can specify the initial number of seconds to wait before AsyncOS will send a duplicate alert. If you set this value to 0, duplicate alert summaries are not sent and instead, all duplicate alerts are sent without any delay (this can lead to a large amount of email over a short amount of time). The number of seconds to wait between sending duplicate alerts (alert interval) is increased after each alert is sent. The increase is the number of seconds to wait plus twice the last interval. So a 5 second wait would have alerts sent at 5 seconds, 15 seconds, 35 seconds, 75 seconds, 155 seconds, 315 seconds, etc.

Eventually, the interval could become quite large. You can set a cap on the number of seconds to wait between intervals via the maximum number of seconds to wait before sending a duplicate alert field. For example, if you set the initial value to 5 seconds, and the maximum value to 60 seconds, alerts would be sent at 5 seconds, 15 seconds, 35 seconds, 60 seconds, 120 seconds, etc.

## Cisco IronPort AutoSupport

To allow Cisco to better support and design future system changes, the appliance can be configured to send Cisco a copy of all alert messages generated by the system. This feature, called AutoSupport, is a useful way to allow our team to be proactive in supporting your needs. AutoSupport also sends weekly reports noting the uptime of the system, the output of the `status` command, and the AsyncOS version used.

By default, alert recipients set to receive Information severity level alerts for System alert types will receive a copy of every message sent to Cisco. This can be disabled if you do not want to send the weekly alert messages internally. To enable or disable this feature, see [Configuring Alert Settings, page 26-22](#).

## Alert Messages

Alert messages are standard email messages. You can configure the Header From: address, but the rest of the message is generated automatically.

### Alert From Address

You can configure the Header From: address via the **Edit Settings** button or via the CLI.

### Alert Subject

An alert email message's subject follows this format:

```
Subject: [severity]-[hostname]: ([class]) short message
```

## Example Alert Message

```
Date: 23 May 2007 21:10:19 +0000

To: joe@example.com

From: IronPort S650 Alert [alert@example.com]

Subject: Critical <System> example.com: Internal SMTP giving up on message to
jane@company.com with...
```

The Critical message is:

```
Internal SMTP giving up on message to jane@company.com with subject 'IronPort Report:
Client Web Activity (example.com)': Unrecoverable error.
```

```
Product: IronPort S650 Web Security Appliance
```

```
Model: S650
```

```
Version: 5.1.0-225
```

```
Serial Number: XXXXXXXXXXXX-XXXXXXXX
```

```
Timestamp: Tue May 10 09:39:24 2007
```

For more information about this error, please see

<http://support.ironport.com>

If you desire further information, please contact your support provider.

## Managing Alert Recipients

Log in to the S-Series appliance web interface (GUI) and click the System Administration tab. Click the Alerts link in the left menu. For information about how to access the S-Series appliance web interface, see [Accessing the Web Security Appliance, page 2-2](#).

**Figure 26-9 The Alerts Page****Alerts**

Success — The recipient has been saved.

Alert Recipients							
Add Recipient...							
Recipient Address	System	Hardware	Updater	Web Proxy	DVS and Anti-Malware	L4 Traffic Monitor	Delete
jane@example.com	All	Critical Warning	Critical	Critical	Critical Warning	Critical	

Alert Settings	
From Address to Use When Sending Alerts:	Automatically Generated
Initial Number of Seconds to Wait Before Sending a Duplicate Alert:	300
Maximum Number of Seconds to Wait Before Sending a Duplicate Alert:	3600
IronPort AutoSupport:	Disabled
<a href="#">Edit Settings...</a>	

**Note**

If you enabled AutoSupport during System Setup, the email address you specified will receive alerts for all severities and classes by default. You can change this configuration at any time.

The Alerts page lists the existing alert recipients and alert settings.

From the Alerts page, you can:

- Add, configure, or delete alert recipients
- Modify the alert settings

## Adding New Alert Recipients

- 
- Step 1** Click **Add Recipient...** on the Alerts page.
- Step 2** Enter the recipient's email address. You can enter multiple addresses, separated by commas.
- Step 3** Select which alert severities to receive.
- Step 4** Submit and commit your changes.
- 

## Configuring Existing Alert Recipients

- 
- Step 1** Click the alert recipient in the Alert Recipients listing.
- Step 2** Make changes to the alert recipient.
- Step 3** Submit and commit your changes.
- 

## Deleting Alert Recipients

- 
- Step 1** Click the trash can icon corresponding to the alert recipient in the Alert Recipient listing.
- Step 2** Confirm the deletion by clicking **Delete** in the warning dialog that appears.

**Step 3** Commit your changes.

## Configuring Alert Settings

Alert settings are global settings, meaning that they affect how all of the alerts behave.

### Editing Alert Settings

**Step 1** Click **Edit Settings...** on the Alerts page.

**Figure 26-10** Editing Alert Settings

#### Edit Alert Settings

Alert Settings	
From Address to Use When Sending Alerts:	<input type="text"/> <input checked="" type="radio"/> Automatically generated <small>(example: IronPort Alert &lt;alert@host.example.com&gt;)</small>
Wait Before Sending a Duplicate Alert:	<input checked="" type="checkbox"/> Enable <input type="text" value="300"/> Initial Number of Seconds to Wait Before Sending a Duplicate Alert <input type="text" value="3600"/> Maximum Number of Seconds to Wait Before Sending a Duplicate Alert
IronPort AutoSupport:	<input type="checkbox"/> Enable <input checked="" type="checkbox"/> Send copy of weekly AutoSupport reports to System Information Alert recipients.
<input type="button" value="Cancel"/> <span style="float: right;"><input type="button" value="Submit"/></span>	

**Step 2** Enter a Header From: address to use when sending alerts, or select **Automatically Generated** (“alert@<hostname>”).

**Step 3** Mark the checkbox if you want to specify the number of seconds to wait between sending duplicate alerts. For more information, see [Sending Duplicate Alerts, page 26-18](#).

- Specify the initial number of seconds to wait before sending a duplicate alert.
- Specify the maximum number of seconds to wait before sending a duplicate alert.

**Step 4** You can enable AutoSupport by checking the Cisco IronPort AutoSupport option. For more information about AutoSupport, see [Cisco IronPort AutoSupport, page 26-18](#).

- If AutoSupport is enabled, the weekly AutoSupport report is sent to alert recipients set to receive System alerts at the Information level. You can disable this via the checkbox.

**Step 5** Submit and commit your changes.

## Alert Listing

The following sections list alerts by classification. The table in each section includes the alert name (internally used descriptor), actual text of the alert, description, severity (critical, information, or warning) and the parameters (if any) included in the text of the message. The value of the parameter is replaced in the actual text of the alert. For example, an alert message below may mention “\$ip” in the message text. “\$ip” is replaced by the actual IP address when the alert is generated.



## Feature Key Alerts

Table 26-5 contains a list of the various feature key alerts that can be generated by AsyncOS, including a description of the alert and the alert severity.

**Table 26-5 Listing of Possible Feature Key Alerts**

Message	Alert Severity	Parameters
A "\$feature" key was downloaded from the IronPort key server and placed into the pending area. EULA acceptance required.	Information.	<b>\$feature:</b> Name of the feature.
Your "\$feature" evaluation key has expired. Please contact your authorized IronPort sales representative.	Warning.	<b>\$feature:</b> Name of the feature.
Your "\$feature" evaluation key will expire in under \$days day(s). Please contact your authorized IronPort sales representative.	Warning.	<b>\$feature:</b> Name of the feature. <b>\$days:</b> The number of days that will pass before the feature key will expire.

## Hardware Alerts

Table 26-6 contains a list of the various hardware alerts that can be generated by AsyncOS, including a description of the alert and the alert severity.

**Table 26-6 Listing of Possible Hardware Alerts**

Message	Alert Severity	Parameters
A RAID-event has occurred: \$error	Warning	<b>\$error:</b> Text of the RAID error.

## Logging Alerts

Table 26-7 contains a list of the various logging alerts that can be generated by AsyncOS, including a description of the alert and the alert severity.

**Table 26-7 Listing of Possible Logging Alerts**

Message	Alert Severity	Parameters
\$error.	Information.	<b>\$error:</b> The traceback string of the error.
Log Error: Subscription \$name: Log partition is full.	Critical.	<b>\$name:</b> Log subscription name.
Log Error: Push error for subscription \$name: Failed to connect to \$ip: \$reason.	Critical.	<b>\$name:</b> Log subscription name. <b>\$ip:</b> IP address of the remote host. <b>\$reason:</b> Text describing the connect error
Log Error: Push error for subscription \$name: An FTP command failed to \$ip: \$reason.	Critical.	<b>\$name:</b> Log subscription name. <b>\$ip:</b> IP address of the remote host. <b>\$reason:</b> Text describing what went wrong.

Table 26-7 Listing of Possible Logging Alerts (continued)

Message	Alert Severity	Parameters
Log Error: Push error for subscription \$name: SCP failed to transfer to \$ip:\$port: \$reason',	Critical.	<b>\$name:</b> Log subscription name. <b>\$ip:</b> IP address of the remote host. <b>\$port:</b> Port number on the remote host. <b>\$reason:</b> Text describing what went wrong.
Log Error: 'Subscription \$name: Failed to connect to \$hostname (\$ip): \$error.	Critical.	<b>\$name:</b> Log subscription name. <b>\$hostname:</b> Hostname of the syslog server. <b>\$ip:</b> IP address of the syslog server. <b>\$error:</b> Text of the error message.
Log Error: Subscription \$name: Network error while sending log data to syslog server \$hostname (\$ip): \$error	Critical.	<b>\$name:</b> Log subscription name. <b>\$hostname:</b> Hostname of the syslog server. <b>\$ip:</b> IP address of the syslog server. <b>\$error:</b> Text of the error message.
Subscription \$name: Timed out after \$timeout seconds sending data to syslog server \$hostname (\$ip).	Critical.	<b>\$name:</b> Log subscription name. <b>\$timeout:</b> Timeout in seconds. <b>\$hostname:</b> Hostname of the syslog server. <b>\$ip:</b> IP address of the syslog server.
Subscription \$name: Syslog server \$hostname (\$ip) is not accepting data fast enough.	Critical.	<b>\$name:</b> Log subscription name. <b>\$hostname:</b> Hostname of the syslog server. <b>\$ip:</b> IP address of the syslog server.
Subscription \$name: Oldest log file(s) were removed because log files reached the maximum number of \$max_num_files. Files removed include: \$files_removed.	Information.	<b>\$name:</b> Log subscription name. <b>\$max_num_files:</b> Maximum number of files allowed per log subscription. <b>\$files_removed:</b> List of files that were removed.

## Reporting Alerts

Table 26-8 contains a list of the various reporting alerts that can be generated by AsyncOS, including a description of the alert and the alert severity.

Table 26-8 Listing of Possible Reporting Alerts

Message	Alert Severity	Parameters
The reporting system is unable to maintain the rate of data being generated. Any new data generated will be lost.	Critical.	Not applicable.
The reporting system is now able to handle new data.	Information.	Not applicable.

Table 26-8 Listing of Possible Reporting Alerts (continued)

Message	Alert Severity	Parameters
A failure occurred while building periodic report '\$report_title'.  This subscription should be examined and deleted if its configuration details are no longer valid.	Critical.	<b>\$report_title:</b> Title of the report.
A failure occurred while emailing periodic report '\$report_title'.  This subscription has been removed from the scheduler.	Critical.	<b>\$report_title:</b> Title of the report.
Processing of collected reporting data has been disabled due to lack of logging disk space. Disk usage is above \$threshold percent. Recording of reporting events will soon become limited and reporting data may be lost if disk space is not freed up (by removing old logs, etc).  Once disk usage drops below \$threshold percent, full processing of reporting data will be restarted automatically.	Warning.	<b>\$threshold:</b> Threshold value.
PERIODIC REPORTS: While building periodic report '\$report_title' the expected domain specification file could not be found at '\$file_name'. No reports were sent.	Critical.	<b>\$report_title:</b> Title of the report. <b>\$file_name:</b> Name of the file.
Counter group "\$counter_group" does not exist.	Critical.	<b>\$counter_group:</b> Name of the counter_group.
PERIODIC REPORTS: While building periodic report '\$report_title' the domain specification file '\$file_name' was empty. No reports were sent.	Critical.	<b>\$report_title:</b> Title of the report. <b>\$file_name:</b> Name of the file.
PERIODIC REPORTS: Errors were encountered while processing the domain specification file '\$file_name' for the periodic report '\$report_title'. Any line which has any reported problem had no report sent.  \$error_text	Critical.	<b>\$report_title:</b> Title of the report. <b>\$file_name:</b> Name of the file. <b>\$error_text:</b> List of errors encountered.

Table 26-8 Listing of Possible Reporting Alerts (continued)

Message	Alert Severity	Parameters
<p>Processing of collected reporting data has been disabled due to lack of logging disk space. Disk usage is above \$threshold percent. Recording of reporting events will soon become limited and reporting data may be lost if disk space is not freed up (by removing old logs, etc).</p> <p>Once disk usage drops below \$threshold percent, full processing of reporting data will be restarted automatically.</p>	Warning.	<b>\$threshold:</b> Threshold value.
<p>The reporting system has encountered a critical error while opening the database. In order to prevent disruption of other services, reporting has been disabled on this machine. Please contact customer support to have reporting enabled.</p> <p>The error message is:</p> <p>\$serr_msg</p>	Critical.	<b>\$serr_msg:</b> Error message text.

## System Alerts

Table 26-9 contains a list of the various system alerts that can be generated by AsyncOS, including a description of the alert and the alert severity.

Table 26-9 Listing of Possible System Alerts

Message	Alert Severity	Parameters
Startup script \$name exited with error: \$message	Critical.	<b>\$name:</b> Name of the script. <b>\$message:</b> Error message text.
System halt failed: \$exit_status: \$output',	Critical.	<b>\$exit_status:</b> Exit code of the command. <b>\$output:</b> Output from the command.
System reboot failed: \$exit_status: \$output	Critical.	<b>\$exit_status:</b> Exit code of the command. <b>\$output:</b> Output from the command.
Process \$name listed \$dependency as a dependency, but it does not exist.	Critical.	<b>\$name:</b> Name of the process. <b>\$dependency:</b> Name of the dependency that was listed.
Process \$name listed \$dependency as a dependency, but \$dependency is not a wait_init process.	Critical.	<b>\$name:</b> Name of the process. <b>\$dependency:</b> Name of the dependency that was listed.
Process \$name listed itself as a dependency.	Critical.	<b>\$name:</b> Name of the process.
Process \$name listed \$dependency as a dependency multiple times.	Critical.	<b>\$name:</b> Name of the process. <b>\$dependency:</b> Name of the dependency that was listed.

**Table 26-9 Listing of Possible System Alerts (continued)**

Message	Alert Severity	Parameters
Dependency cycle detected: \$cycle.	Critical.	<b>\$cycle:</b> The list of process names involved in the cycle.
An error occurred while attempting to share statistical data through the Network Participation feature. Please forward this tracking information to your IronPort support provider: Error: \$error.	Warning.	<b>\$error:</b> The error message associated with the exception.
There is an error with "\$name".	Critical.	<b>\$name:</b> Name of the process that generated a core file.
An application fault occurred: "\$error"	Critical.	<b>\$error:</b> Text of the error, typically a traceback.
Tech support: Service tunnel has been enabled, port \$port	Information.	<b>\$port:</b> Port number used for the service tunnel.
Tech support: Service tunnel has been disabled.	Information.	Not applicable.

## Updater Alerts

Table 26-10 contains a list of the various updater alerts that can be generated by AsyncOS, including a description of the alert and the alert severity.

**Table 26-10 Listing of Possible Updater Alerts**

Message	Alert Severity	Parameters
The \$app application tried and failed \$attempts times to successfully complete an update. This may be due to a network configuration issue or temporary outage.	Warning.	<b>\$app:</b> Web Security appliance security service name. <b>\$attempts:</b> Number of attempts tried.
The updater has been unable to communicate with the update server for at least \$threshold.	Warning.	<b>\$threshold:</b> Threshold value time.
Unknown error occurred: \$traceback.	Critical.	<b>\$traceback:</b> Traceback information.

## FIPS Compliance

Federal Information Processing Standards (FIPS) specify requirements for cryptographic modules that are used by all government agencies to protect sensitive but unclassified information. FIPS help ensure compliance with federal security and data privacy requirements. FIPS, developed by the National Institute for Standards and Technology (NIST), are to use when no voluntary standards exist to meet federal requirements.

The WSA achieves FIPS 140-2 Level 1 compliance in FIPS mode using Cisco Common Cryptographic Module (C3M). By default, FIPS mode is disabled.

## FIPS Certificate Requirements

FIPS Mode requires a certificate that meets these requirements:

Certificate	Algorithm	Bit Key Size	Signature Algorithm	Notes
X509	RSA	1024	sha1WithRSAEncryption	For best decryption performance and sufficient security, Cisco recommends a bit key size of 1024.
	RSA	2048, 3072 or 4096	sha1WithRSAEncryption	Bit sizes larger than 1024 will increase security, but impact decryption performance.
	DSA	1024	dsaWithSHA1	For best decryption performance and sufficient security, Cisco recommends a bit key size of 1024.

## Entering and Exiting FIPS Mode

### Before You Begin

- Be aware that both entering and exiting FIPS mode initiates a reboot of the appliance.
- Ensure the certificates to be used in FIPS mode use FIPS 140-2 approved public key algorithms.
- Login to an administrator account

## Web Interface

- 
- Step 1** On the System Administration > FIPS Mode page, click Edit Settings.
- Step 2** [Select | Deselect] Enable FIPS Level 1 Compliance.
- Step 3** Click Submit.
- Step 4** Click Continue to allow the appliance to reboot.
- 

## Command Line Interface

Command	Subcommand	Description
<code>fipsconfig</code>	<code>setup</code>	Enter and exit FIPS mode.

## System Date and Time Management

Your Web Security appliance can track the current date and time by querying a Network Time Protocol (NTP) server or you can manually set the system date and time. The system date and time reflects the time zone, which you can set either by GMT offset or by global region, country, and then local time zone.

Both the GUI and the CLI allow you to adjust the time zone and either manually set system date/time or identify an NTP server to query.

## System Date and Time Management Using the CLI

Command	Subcommand	Description
<code>ntpconfig</code>		Synchronize the system date and time with an NTP server. Without a subcommand, lists the NTP servers that are currently configured.
	<code>new</code>	Add a new NTP server to the configuration. Enter the fully qualified hostname or IP address of the NTP server.
	<code>delete</code>	Delete an NTP server from the configuration. Enter the fully qualified hostname or IP address of the NTP server.
<code>settime</code>		Manually set the system date and time. Enter the time in MM/DD/YYYY HH:MM:SS format.
<code>settz</code>	<code>setup</code>	Set the time zone, specifying region, country, and country-specific time zone.

## System Date and Time Management Using the GUI

### GMT Offsets

In the GUI, you can specify the time zone using a GMT offset if you choose. GMT offset refers to the time difference, in hours, between the local time and Greenwich Mean Time (GMT). GMT is the current local time in Greenwich, UK, which is located at the Prime Meridian. Hours preceded by a minus sign (“-”) are *east* of the Prime Meridian. A plus sign (“+”) indicates *west* of the Prime Meridian.

For example, the GMT offset for New York City is +5. There are five hours difference between local time in New York City and GMT. New York City is *west* of the Prime Meridian. Adding five hours to the local time in New York City gives you GMT.

### Setting the Time Zone

- 
- Step 1** Navigate to System Administration > Time Zone.
  - Step 2** Click Edit Settings.
  - Step 3** Select your region, country, and time zone or select the GMT offset. (See [System Date and Time Management Using the CLI, page 26-29.](#))
  - Step 4** Submit and commit the changes.
-

## Synchronizing the System Clock with an NTP Server

- 
- Step 1** Navigate to System Administration>Time Settings.
  - Step 2** Click Edit Settings.
  - Step 3** Select Use Network Time Protocol as the Time Keeping Method.
  - Step 4** Enter the fully qualified hostname or IP address of the NTP server, clicking Add Row as needed to add servers.
  - Step 5** Submit and commit the changes.
- 

## Deleting an NTP Server from the Configuration

- 
- Step 1** Navigate to System Administration>Time Settings.
  - Step 2** Click Edit Settings.
  - Step 3** Click the garbage can icon to the right of the server name to delete it.
  - Step 4** Submit and commit the changes.
- 

## Manually Setting the System Date and Time in the GUI

- 
- Step 1** Navigate to System Administration > Time Settings.
  - Step 2** Select Set Time Manually.
  - Step 3** Set the date and time.
  - Step 4** Click Submit.
- 

## Installing a Server Digital Certificate

When an administrator logs into the Web Security appliance using HTTPS, the appliance uses a digital certificate to securely establish the connection with the client application. The Web Security appliance uses the “Cisco IronPort Web Security Appliance Demo Certificate” that comes installed by default. However, client applications are not programmed to recognize this certificate, so you can upload a digital certificate to the appliance that your applications recognize automatically.

[Figure 26-11](#) shows the warning message that is displayed in Firefox when accessing the Web Security appliance using the Cisco IronPort Web Security Appliance Demo Certificate.

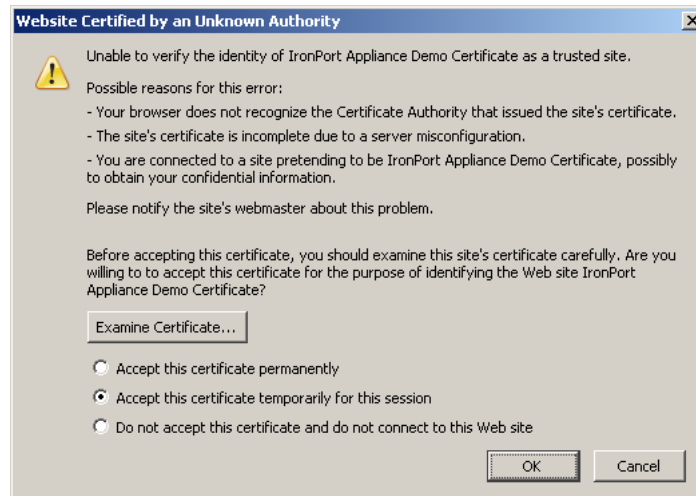

**Figure 26-11** Cisco IronPort Web Security Appliance Demo Certificate as an Unknown Authority

To configure the Web Security appliance to use a different digital server certificate, follow these steps:

- 
- Step 1** Obtain a certificate and private key pair to upload. For more information, see [Obtaining Certificates, page 26-31](#).
  - Step 2** Upload the certificate and private key pair to the appliance. For more information, see [Uploading Certificates to the Web Security Appliance, page 26-32](#).

## Obtaining Certificates

- 
- Step 1** Generate a public-private key pair.
  - Step 2** Generate a Certificate Signing Request (CSR).
  - Step 3** Contact a certificate authority (CA) to sign the certificate.
- 

The certificate you upload to the appliance must meet the following requirements:

- It must use the X.509 standard.
- It must include a matching private key in PEM format. DER format is not supported.
- The private key must be unencrypted.

The Web Security appliance cannot generate Certificate Signing Requests (CSR) for certificates uploaded to the appliance. Therefore, to have a certificate created for the appliance, you must issue the signing request from another system. Save the PEM-formatted key from this system because you will need to install it on the appliance later.

You can use any UNIX machine with a recent version of OpenSSL installed. Be sure to put the appliance hostname in the CSR. Use the guidelines at the following location for information on generating a CSR using OpenSSL:

[http://www.modssl.org/docs/2.8/ssl\\_faq.html#ToC28](http://www.modssl.org/docs/2.8/ssl_faq.html#ToC28)

Once the CSR has been generated, submit it to a certificate authority (CA). The CA will return the certificate in PEM format.

If you are acquiring a certificate for the first time, search the Internet for “certificate authority services SSL server certificates,” and choose the service that best meets the needs of your organization. Follow the service’s instructions for obtaining an SSL certificate.

**Note**

You can also generate and sign your own certificate. Tools for doing this are included with OpenSSL, free software from <http://www.openssl.org>.

## Intermediate Certificates

In addition to root certificate authority (CA) certificate verification, AsyncOS supports the use of intermediate certificate verification. Intermediate certificates are certificates issued by a trusted root CA which are then used to create additional certificates. This creates a chained line of trust. For example, a certificate may be issued by example.com who, in turn, is granted the rights to issue certificates by a trusted root CA. The certificate issued by example.com must be validated against example.com’s private key as well as the trusted root CA’s private key.

## Uploading Certificates to the Web Security Appliance

To upload a digital certificate to the Web Security appliance, use the `certconfig` command.

The following example shows a certificate being uploaded. You can also add intermediate certificates from this command.

```
example.com> certconfig
```

```
Currently using the demo certificate/key for HTTPS management access.
```

```
Choose the operation you want to perform:
```

```
- SETUP - Configure security certificate and key.
```

```
[ ]> setup
```

```
Management (HTTPS):
```

```
paste cert in PEM format (end with '.'):

```

```
-----BEGIN CERTIFICATE-----

```

```
MIICLDCAdYCAQAwDQYJKoZIhvcNAQEEBQAwwgaAxCzAJBgNVBAYTAlBUMRMwEQYD

```

```
VQOIeWpRdWV1bnNsYW5kMQ8wDQYDVQQHEwZMaXN1b2ExFzAVBgNVBAoTDk51dXJv

```

```
bmlvLlCBMzGZeuMRgwFgYDVQQLEw9EZXR1bnZvbHJpbWVudG8xGzAZBgNVBAMTEmJy

```

```
dXR1cy5uZXVyb25pby5wdDEbMBkGCSqGSIb3DQEJARYMc2FtcG9AaWtpLmZpMB4X

```

```
DTk2MDkwNTAzNDI0M1oXDTk2MTAwNTAzNDI0M1owgaAx CzA JBGNVBAYTA1BUMRMw
EQYDVQQIEwpRdWVlbnNsYW5kMQ8wDQYDVQQHEwZMaXNib2ExFzAVBgNVBAoTDk51
dXJvbmlvLCBMZGEuMRgwFgYDVQQLew9EZXXNlbnZvbHZpbWVudG8xGzAZBgNVBAMT
EmJydXR1cy5uZXVyb25pby5wdDEbMBkGCSqGSIb3DQEJARYMc2FtcG9AaWtpLmZp
MFwwDQYJKoZIhvcNAQEBBQADSwAwSAJBAL7+aty3S1iBA/+yxjxv4q1MUTd1kjNw
L4lYKbpzzlmc5beaQXeQ2RmGMTXU+mDvuqItjVHOK3DvPK7lTcSGftUCAwEAATAN
BgkqhkiG9w0BAQQFAANBAFgPEKfjk6T6CKTHvaQeEAsX0/8YHPHQH/9AnhSjrwuX
9EBc0n6bVGhn7XaXd6sJ7dym9sbsWxb+pJdurnkxjx4=
-----END CERTIFICATE-----
```

.

paste key in PEM format (end with '.')

```
-----BEGIN RSA PRIVATE KEY-----
MIIBPAIBAAJBAL7+aty3S1iBA/+yxjxv4q1MUTd1kjNwL4lYKbpzzlmc5beaQXeQ
2RmGMTXU+mDvuqItjVHOK3DvPK7lTcSGftUCAwEAAQJBALjkK+jc2+iihI98riEF
oudmknziSRTYjnwjx8mCoAjPWviB3c742e03FG4/soi1jD9A5alihEOXFUzloenr
8IECIQD3B5+0l+68BA/6d76iUNqAAV8djGTzvxnCxycnxPQydQIhAMXt4trUI3nc
a+U8YL2HPFA3gmhBsSICbq2OptOCnM7hAiEA6Xi3JIQECob8YwKRj29DU3/4WYD7
WLPgsQpwo1GuSpECICGsnWH5oaeD9t9jbFoSfhJvv0IZmxdclpRcpslpeWBBAiEA
6/5B8J0GHdJq89FHwEG/H2eVVUYu5y/aD6sgcm+0Avg=
-----END RSA PRIVATE KEY-----
```

.

Do you want add an intermediate certificate? [N]> N

Currently using custom certificate/key for HTTPS management access.

Choose the operation you want to perform:

- SETUP - Configure security certificate and key.

```
[ ]>
```

```
example.com> commit
```

Please enter some comments describing your changes:

```
[ ]> Installed certificate and key for HTTPS management.
```

```
Changes committed: Fri Sep 26 17:59:53 2008 GMT
```

## Upgrading AsyncOS for Web

- 
- Step 1 Configure the update and upgrade settings.** You can configure settings that affect how the Web Security appliance downloads the upgrade information. For example, you can choose from where to download the upgrade images and more. For more information, see [Configuring Upgrade and Service Update Settings, page 26-36](#).
- Step 2 Upgrade the system software.** After you configure the update and upgrade settings, upgrade the software on the appliance. If you have Upgrade Notifications turned on the appliance, administrators will see a message at the top of the Web Interface notifying them of an available upgrade. For more information, see [Upgrading AsyncOS for Web from the Web Interface, page 26-35](#) and [Upgrading AsyncOS for Web from the CLI, page 26-36](#).
- 

Consider the following guidelines when you upgrade AsyncOS for Web:

- Before you start the upgrade, save the XML configuration file off the Web Security appliance from the System Administration > Configuration File page or by using the `saveconfig` command. For more information, see [Saving and Loading the Appliance Configuration, page 26-1](#).
- When upgrading, do not pause for long amounts of time at the various prompts. If the TCP session times out during the download, the upgrade may fail.
- Consider saving other files stored on the appliance, such as PAC files or customized end-user notification pages.
- Consider saving the configuration information to an XML file after the upgrade completes, too.

## Available Upgrade Notifications

You can configure the Web Security appliance to display a message at the top of the web interface notify you that an upgrade to AsyncOS is available for the appliance. AsyncOS displays this notification for any administrator logged into the appliance.

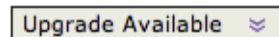
**Figure 26-12 Upgrade Available Notification**

Hover over the notification with your mouse cursor to view the number of upgrades available for the appliance and the version and build number of the latest available upgrade.

**Figure 26-13 AsyncOS Upgrade Build Information**

Click the down arrows in the lower right corner to expand the notification window. The window displays a link to the System Administration > System Upgrade page for you to start the upgrade.

To dismiss the message, check the **Clear the notification** check box and click **Close**. The appliance will not display another notification until a new upgrade becomes available.

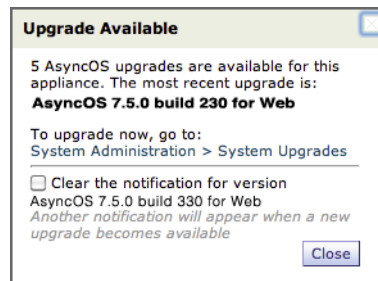
**Figure 26-14 Expanded Upgrade Available Window**

You can enable these notifications on your appliance using the System Administration > Upgrade and Update Settings page. See [Configuring Upgrade and Service Update Settings, page 26-36](#) for more information.

## Upgrading AsyncOS for Web from the Web Interface

- 
- Step 1** On the System Administration > Configuration File page, save the XML configuration file off the Web Security appliance.
  - Step 2** On the System Administration > System Upgrade page, click **Available Upgrades**.
  - Step 3** Select an upgrade from the list of available upgrades, and click **Begin Upgrade** to start the upgrade process. Answer the questions as they appear.
  - Step 4** When the upgrade is complete, click **Reboot Now** to reboot the Web Security appliance.
-

## Upgrading AsyncOS for Web from the CLI

Issue the `upgrade` command from the CLI to show a list of available upgrades. Select the desired upgrade from the list to install it. You may be asked to confirm messages or read and agree to license agreements, etc.

### Differences from Traditional Upgrading Method

Please note these differences when upgrading AsyncOS from a local server as opposed to the traditional method:

1. The upgrading installs immediately *while downloading*.
  2. A banner displays for 10 seconds at the beginning of the upgrade process. While this banner is displayed, you have the option to type Control+C to exit the upgrade process before downloading starts.
- 

## Configuring Upgrade and Service Update Settings

You can configure how the Web Security appliance downloads security services updates, such as Web Reputation Filters and AsyncOS for Web upgrades. For example, you can choose which network interface to use when downloading the files, configure the update interval, or disable automatic updates.

AsyncOS periodically queries the update servers for new updates to all security service components, but not for new AsyncOS upgrades. To upgrade AsyncOS, you must manually prompt AsyncOS to query for available upgrades. You can also manually prompt AsyncOS to query for available security service updates. For more information, see [Manually Updating Security Service Components, page 26-41](#).

When AsyncOS queries an update server for an update or upgrade, it performs the following steps:

1. Contacts the update server.
  - Cisco allows the following sources for update servers:
    - **Cisco IronPort update servers.** For more information, see [Updating and Upgrading from the Cisco IronPort Update Servers, page 26-37](#).
    - **Local server.** For more information, see [Upgrading from a Local Server, page 26-38](#).
2. Receives an XML file that lists the available updates or AsyncOS upgrade versions. This XML file is known as the “manifest.”
3. Downloads the update or upgrade image files.

By default, AsyncOS contacts the Cisco IronPort update servers for both update and upgrade images and the manifest XML file. However, you can choose from where to download the upgrade and update images and the manifest file. You might want to specify a local update server for the images or manifest file for any of the following reasons:

- **You have multiple appliances to upgrade simultaneously.** If your organization has multiple Web Security appliances that need to upgrade, you can download the upgrade image to a web server inside your network and serve it to all appliances in your network.

- **Your firewall settings require static IP addresses for the Cisco IronPort update servers.** The Cisco IronPort update servers use dynamic IP addresses. If you have strict firewall policies, you may need to configure a static location for updates and AsyncOS upgrades. For more information, see [Configuring a Static Address for the Cisco IronPort Update Servers, page 26-37](#).

**Note**

Only use a local update server for upgrade images, not update images. When you specify a local update server, the local server does not automatically receive updated security service updates from Cisco, so the appliances in your network eventually become out of date. Use a local update server for upgrading AsyncOS, and then change the update and upgrade settings back to use the Cisco IronPort update servers so the security services update automatically again.

You can configure upgrade and updates settings in the web interface or the CLI. For more information, see [Configuring the Update and Upgrade Settings from the Web Interface, page 26-39](#) and [Configuring the Update and Upgrade Settings from the CLI, page 26-41](#).

[Figure 26-15](#) shows where you configure upgrade and update settings in the web interface.

**Figure 26-15** System Administration > Upgrade and Update Settings Page

#### Upgrade and Update Settings

Update Settings for Security Services	
Update Server (list):	Dynamic (IronPort Update Server)
Update Server (images):	Dynamic (IronPort Update Server)
Automatic Updates:	Enabled
Update Interval:	5m
Routing Table:	Management
Proxy Server:	Not Enabled

[Edit Update Settings...](#)

## Updating and Upgrading from the Cisco IronPort Update Servers

The Web Security appliance can connect directly to the Cisco IronPort update servers and download upgrade images and security service updates. Each appliance downloads the updates and upgrade images separately.

Cisco uses a distributed update server architecture to make sure customers can quickly download updates and AsyncOS upgrades wherever in the world they are located. Because of this distributed server architecture, the Cisco IronPort update servers use dynamic IP addresses. If you have strict firewall policies, you may need to configure a static location for AsyncOS upgrades. For more information, see [Configuring a Static Address for the Cisco IronPort Update Servers, page 26-37](#).

### Configuring a Static Address for the Cisco IronPort Update Servers

The Cisco IronPort update servers use dynamic IP addresses. If you have strict firewall policies, you may need to configure a static location for updates and AsyncOS upgrades.

- Step 1** Contact Cisco IronPort Customer Support to obtain the static URL address.
- Step 2** Navigate to the System Administration > Upgrade and Update Settings page, and click **Edit Update Settings**.
- Step 3** On the Edit Update Settings page, in the “Update Servers (images)” section, choose Local Update Servers and enter the static URL address received in step 1.

- Step 4** Verify that Cisco IronPort Update Servers is selected for the “Update Servers (list)” section.
- Step 5** Submit and commit your changes.

## Upgrading from a Local Server

The Web Security appliance can download AsyncOS upgrades from a server within your network instead of obtaining upgrades directly from the Cisco IronPort update servers. When you use this feature, you only download the upgrade image from Cisco one time, and then serve it to all Web Security appliances in your network.

Figure 26-16 shows how Web Security appliances download upgrade images from local servers.

**Figure 26-16** Upgrading from a Local Server

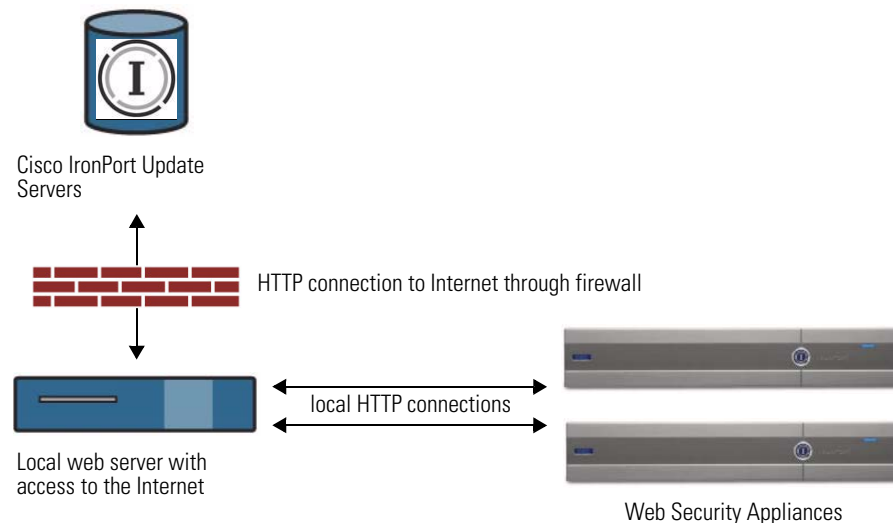

- Step 1** Configure a local server to retrieve and serve the upgrade files.
- Step 2** Download the upgrade zip file.
- Using a browser on the local server, go to [http://updates.ironport.com/fetch\\_manifest.html](http://updates.ironport.com/fetch_manifest.html) to download a zip file of an upgrade image. To download the image, enter your serial number (for a physical appliance) or VLN (for a virtual appliance) and the version number of the appliance. You will then be presented with a list of available upgrades. Click on the upgrade version that you want to download.
- Step 3** Unzip the zip file in the root directory on the local server while keeping the directory structure intact.
- Step 4** Configure the appliance to use the local server using the System Administration > Upgrade and Update Settings page or the `updateconfig` command.
- Step 5** On the System Administration > System Upgrade page, click **Available Upgrades** or run the `upgrade` command.



**Note**

Cisco recommends changing the update and upgrade settings to use the Cisco IronPort update servers (using dynamic or static addresses) after the upgrade is complete to ensure the security service components continue to update automatically.

## Hardware and Software Requirements for Local Upgrade Servers

For *downloading* AsyncOS upgrade files, you must have a system in your internal network that has a web browser (see [Browser Requirements, page 2-5](#)) and Internet access to the Cisco IronPort update servers.

**Note**

If you need to configure a firewall setting to allow HTTP access to this address, you must configure it using the DNS name and not a specific IP address.

For *hosting* AsyncOS upgrade files, a server on the internal network must have a web server, such as Microsoft IIS (Internet Information Services) or the Apache open source server, which has the following features:

- Supports the display of directory or filenames in excess of 24 characters.
- Has directory browsing enabled.
- Is configured for anonymous (no authentication) or Basic (“simple”) authentication.
- Contains at least 350MB of free disk space for each AsyncOS upgrade image.

## Configuring the Update and Upgrade Settings from the Web Interface

**Step 1** Navigate to the System Administration > Upgrade and Update Settings page, and click **Edit Update Settings**.

**Step 2** Configure the settings, referencing the information in [Table 26-11](#).

**Table 26-11** *Update and Upgrade Settings*

Setting	Description
Automatic Updates	Choose whether or not to enable automatic updates of the security components. If you choose automatic updates, enter the time interval. The default is enabled and the update interval is 5 minutes.
Upgrade Notifications	Choose whether to display a notification at the top of the Web Interface when a new upgrade to AsyncOS is available. The appliance only displays this notification for administrators.  For more information, see <a href="#">Available Upgrade Notifications, page 26-34</a> .

**Table 26-11 Update and Upgrade Settings (continued)**

Setting	Description
Update Servers (list)	<p>Choose whether to download the list of available upgrades and updates (the manifest XML file) from the Cisco IronPort update servers or a local web server.</p> <p>The default is the Cisco IronPort update servers. You might want to choose a local web server when you want to temporarily download an upgrade image stored on a local web server. After you download the image, Cisco recommends changing this setting back to the Cisco IronPort update servers so that security components continue to update automatically.</p> <p>When you choose a local update server, enter the full path to the manifest XML file for the list including the file name and port number for the server. If you leave the port field blank, AsyncOS uses port 80. If the server requires authentication, you can also enter a valid user name and password.</p> <p>For more information, see <a href="#">Upgrading from a Local Server, page 26-38</a>.</p>
Update Servers (images)	<p>Choose whether to download upgrade and update images from the Cisco IronPort update servers or a local web server. The default is the Cisco IronPort update servers. You might want to choose a local web server under either of the following circumstances:</p> <ul style="list-style-type: none"> <li>You want to download the upgrade and update images from Cisco, but you need to enter a static address provided by Cisco IronPort Customer Support.</li> <li>You want to temporarily download an upgrade image stored on a local web server. After you download the image, Cisco recommends changing this setting back to the Cisco IronPort update servers (or the static address if you used that) so that security components continue to update automatically.</li> </ul> <p>When you choose a local update server, enter the base URL and port number for the server. If you leave the port field blank, AsyncOS uses port 80. If the server requires authentication, you can also enter a valid user name and password.</p> <p>For more information, see <a href="#">Updating and Upgrading from the Cisco IronPort Update Servers, page 26-37</a> and <a href="#">Upgrading from a Local Server, page 26-38</a>.</p>
Routing Table	<p>Choose which network interface's routing table to use when contacting the update servers. The available proxy data interfaces are shown. Default is Management.</p>
Proxy Server (optional)	<p>If an upstream proxy server exists and requires authentication, enter the server information and user name and password here.</p>

**Step 3** Submit and commit your changes.

## Configuring the Update and Upgrade Settings from the CLI

The `updateconfig` command is used to configure update and upgrade settings, such as where the appliance looks for service updates and AsyncOS upgrades. The settings you configure using the `updateconfig` command are the same as you can define in the web interface. For more information on these settings, see [Table 26-11 on page 26-39](#).

**Note**

You can use the `ping` command to ensure that the appliance can contact the local server. You can also use the `telnet` CLI command to telnet to port 80 of the local server to ensure the local server is listening on that port.

## Manually Updating Security Service Components

By default, each security service component periodically receives updates to its database tables from the Cisco IronPort update servers. However, you can manually update the database tables.

Typically, you do not need to manually update to the database tables. In the event a manual update is required, you can modify default settings and configure an update using the options on the System Administration > Upgrade and Update Settings page.

**Note**

Some updates are available on an on-demand basis from the GUI pages related to the feature. For example, to manually update only the set of URL categories, see [Manually Updating the URL Category Set, page 17-8](#).

- 
- Step 1** Navigate to the System Administration > Upgrade and Update Settings page.
  - Step 2** Click **Edit Update Settings**.
  - Step 3** Specify the location of the update files.
  - Step 4** Initiate the update using the Update Now function key on the component page located on the Security Services tab. For example, Security Services > Web Reputation Filters page.
- 

**Note**

Updates that are in-progress cannot be interrupted. All in-progress updates must complete before new changes can be applied.

**Tip**

View a record of update activity in the updater log file. Subscribe to the updater log file on the System Administration > Log Subscriptions page.

## Reverting to a Previous Version of AsyncOS for Web

AsyncOS for Web supports the ability to revert the AsyncOS for Web operating system to a previous qualified build for emergency uses.

**Note**

---

You cannot revert to a version of AsyncOS for Web earlier than version 7.5.

---

Effective in version 7.5, when you upgrade to a later version, the upgrade process automatically saves the current system configuration to a file on the Web Security appliance. (However, Cisco recommends manually saving the configuration file to a local machine as a backup.) This allows AsyncOS for Web to load the configuration file associated with the earlier release after reverting to the earlier version. However, when it performs a reversion, it uses the current network settings for the management interface.

When you revert AsyncOS, you can choose to revert to the currently running build. This allows you to clear all data on the appliance and start with a new, clean configuration.

**Note**

---

If updates to the set of URL categories are available, they will be applied after AsyncOS reversion.

---

## Reverting AsyncOS for an Appliance Managed by the SMA

You can revert AsyncOS for Web from the Web Security appliance. However, if the Web Security appliance is managed by a Security Management appliance, consider the following rules and guidelines:

- When Centralized Reporting is enabled on the Web Security appliance, AsyncOS for Web finishes transferring the reporting data to the Security Management appliance before it starts the reversion. If the files take longer than 40 seconds to transfer to the Security Management appliance, AsyncOS for Web prompts you to continue waiting to transfer the files, or continue the reversion without transferring all files.
- When the Web Security appliance is managed by a Security Management appliance and you revert from one version of AsyncOS for Web to an earlier version, such as reverting from version 7.6 to version 7.5, you must associate the Web Security appliance with the appropriate Configuration Master. Otherwise, pushing a configuration from the Security Management appliance to the Web Security appliance might fail.

## Available Versions

Because upgrades cause one-way transformation of key subsystems, the reversion process is complex and requires qualification by Cisco Quality Assurance teams. Not all prior versions of the AsyncOS for Web operating system are available for reversion. The earliest AsyncOS for Web version supported for this functionality is AsyncOS 7.5.0. Prior versions of AsyncOS for Web are not supported.

## Important Note About Reversion Impact

Reverting the operating system on a Web Security appliance is a very destructive action. This action destroys all configuration logs and databases. In addition, reversion disrupts web traffic handling until the appliance is reconfigured.

Depending on the initial Web Security appliance configuration, this action may destroy network configuration. If this happens, you will need physical local access to the appliance after performing the reversion.

Before you revert AsyncOS for Web, back up the following information from the Web Security appliance to a separate machine:

- System configuration file.
- Log files you want to preserve.
- Reports you want to preserve.
- Customized end-user notification pages stored on the appliance.
- PAC files stored on the appliance.

## Reverting AsyncOS for Web to a Previous Version

---

**Step 1** Save a backup copy of the current configuration of your appliance (with passwords unmasked) on another machine.



**Note** This is not the configuration file that will be loaded after reverting.

---

**Step 2** Back up to a separate machine any of the following files that you might want to preserve:

- Log files
- Reports
- Any customized end-user notification pages stored on the appliance
- Any PAC files stored on the appliance

**Step 3** Log into the CLI of the appliance you want to revert.



**Note** When you run the `revert` command in the next step, several warning prompts are issued. After these warning prompts are accepted, the revert action takes place immediately. Therefore, do not begin the reversion process until after you have completed the pre-reversion steps.

---

**Step 4** From the CLI, enter the `revert` command.

**Step 5** Confirm twice that you want to continue with the reversion.

**Step 6** Choose one of the available versions to revert to.

The appliance reboots twice.



**Note** The reversion process is time-consuming. It may take fifteen to twenty minutes before reversion is complete and console access to the appliance is available again.

---

The appliance should now run using the selected AsyncOS for Web version. You can access the web interface from a web browser.

---

















# 27

## Command Line Interface

---

- [The Command Line Interface Overview, page 27-1](#)
- [Using the Command Line Interface, page 27-1](#)
- [General Purpose CLI Commands, page 27-4](#)
- [Web Security Appliance CLI Commands, page 27-6](#)

### The Command Line Interface Overview

The AsyncOS Command Line Interface (CLI) is an interactive interface designed to allow you to configure and monitor the Web Security appliance. The commands are invoked by entering the command name with or without any arguments. If you enter a command without arguments, the command prompts you for the required information.

The Command Line Interface is accessible using SSH on IP interfaces that have been configured with these services enabled, or using terminal emulation software on the serial port. By default, SSH is configured on the Management port.

### Using the Command Line Interface

This section describes the rules and conventions of the AsyncOS Command Line Interface.

### Accessing the Command Line Interface

Access to the CLI varies depending on the management connection method chosen while setting up the appliance. The factory default username and password are listed next. Initially, only the admin user account has access to the CLI. You can add other users with differing levels of permission after you have accessed the CLI for the first time using the admin account. The System Setup Wizard prompts you to change the password for the admin account.

You can also reset the admin account password at any time using the `passwd` command.

You can connect using one of the following methods:

- **Ethernet.** Start an SSH session with the IP address of the Web Security appliance. The factory default IP address is 192.168.42.42. SSH is configured to use port 22.
- **Serial connection.** Start a terminal session with the communication port on your personal computer that the serial cable is connected to.

Log in to the appliance by entering the username and password below.

- Username: `admin`

- Password: **ironport**

For example:

```
login: admin
```

```
password: ironport
```

## Working with the Command Prompt

The top-level command prompt consists of the fully qualified hostname, followed by the greater than (>) symbol, followed by a space. For example:

```
example.com>
```

When running commands, the CLI requires input from you. When the CLI is expecting input, the prompt displays the default values enclosed in square brackets ([]) followed by the greater than (>) symbol. When there is no default value, the brackets are empty.

For example:

```
example.com> routeconfig
```

```
Choose a routing table:  
- MANAGEMENT - Routes for Management Traffic  
- DATA - Routes for Data Traffic  
[]>
```

When there is a default setting, the setting is displayed within the command-prompt brackets. For example:

```
example.com> setgateway
```

```
Warning: setting an incorrect default gateway may cause the current connection  
to be interrupted when the changes are committed.  
Enter new default gateway:  
[172.xx.xx.xx]>
```

When a default setting is shown, typing Return is equivalent to accepting the default:

## Command Syntax

When operating in the interactive mode, the CLI command syntax consists of single commands with no white space and no arguments or parameters. For example:

```
example.com> logconfig
```

## Select Lists

When you are presented with multiple choices for input, some commands use numbered lists. Enter the number of the selection at the prompt.

For example:

```
Log level:
1. Critical
2. Warning
3. Information
4. Debug
5. Trace
[3]> 3
```

## Yes/No Queries

When given a yes or no option, the question is posed with a default in brackets. You may answer **y**, **n**, **Yes**, or **No**. Case is not significant.

For example:

```
Do you want to enable the proxy? [Y]> Y
```

## Subcommands

Some commands give you the opportunity to use subcommand directives such as **NEW**, **EDIT**, and **DELETE**. The **EDIT** and **DELETE** functions provide a list of previously configured values.

For example:

```
example.com> interfaceconfig

Currently configured interfaces:

1. Management (172.xxx.xx.xx/xx: example.com)

Choose the operation you want to perform:

- NEW - Create a new interface.
- EDIT - Modify an interface.
- DELETE - Remove an interface.

[ ]>
```

Within subcommands, typing Enter or Return at an empty prompt returns you to the main command.

## Escaping Subcommands

You can use the Ctrl+C keyboard shortcut at any time within a subcommand to immediately exit return to the top level of the CLI.

## Command History

The CLI keeps a history of all commands entered during a session. Use the Up and Down arrow keys on your keyboard, or the Ctrl+P and Ctrl+N key combinations to scroll through a running list of the recently-used commands.

## Completing Commands

The AsyncOS CLI supports command completion. You can enter the first few letters of some commands followed by the Tab key and the CLI completes the string. If the letters you entered are not unique among commands, the CLI “narrows” the set. For example:

```
example.com> set (type the Tab key)
setgateway, setgoodtable, sethostname, settime, settz
example.com> seth (typing the Tab again completes the entry with sethostname)
```

## Committing Configuration Changes

Configuration changes do not take effect until you commit them. You can make configuration changes while web operations proceed normally.

- 
- Step 1** Issue the `commit` command at the command prompt.
  - Step 2** Give the `commit` command the input required.
  - Step 3** Receive confirmation of the `commit` procedure at the CLI.
- 



### Note

Changes to configuration that have not been committed are recorded, but do not go into effect until you run the `commit` command. However, not all commands require the `commit` command to be run. Exiting the CLI session, system shutdown, reboot, failure, or issuing the `clear` command clears changes that have not yet been committed.

---

## General Purpose CLI Commands

This section describes the some basic commands you might use in a typical CLI session, such as committing and clearing changes. For a full list of commands, see [Web Security Appliance CLI Commands, page 27-6](#).



## Committing Configuration Changes

The `commit` command allows you to change configuration settings while other operations proceed normally. Changes are not actually committed until you receive confirmation and a timestamp. Exiting the CLI session, system shutdown, reboot, failure, or issuing the `clear` command clears changes that have not yet been committed.

Entering comments after the `commit` command is optional.

```
example.com> commit
```

```
Please enter some comments describing your changes:
```

```
[ ]> Changed "psinet" IP Interface to a different IP address
```

```
Changes committed: Wed Jan 01 12:00:01 2007
```

**Note**

---

To successfully commit changes, you must be at the top-level command prompt. Type Return at an empty prompt to move up one level in the command line hierarchy.

---

## Clearing Configuration Changes

The `clear` command clears any changes made to the appliance configuration since the last `commit` or `clear` command was issued.

```
example.com> clear
```

```
Are you sure you want to clear all changes since the last commit? [Y]> y
```

```
Changes cleared: Wed Jan 01 12:00:01 2007
```

```
example.com>
```

## Exiting the Command Line Interface Session

The `exit` command logs you out of the CLI application. Configuration changes that have not been committed are cleared.

```
example.com> exit
```

```
Configuration changes entered but not committed. Exiting will lose changes.
```

```
Type 'commit' at the command prompt to commit changes.
```

```
Are you sure you wish to exit? [N]> y
```

## Seeking Help on the Command Line Interface

The `help` command lists all available CLI commands and gives a brief description of each command. The `help` command can be invoked by typing either `help` or a single question mark (?) at the command prompt.

```
example.com> help
```

## Web Security Appliance CLI Commands

The Web Security Appliance CLI supports a set of proxy and UNIX commands to access, upgrade, and administer the system.

[Table 27-1](#) lists the Web Security appliance Command Line Interface commands.

**Table 27-1** Web Security appliance Administrative Commands

Command	Description
<code>advancedproxyconfig</code>	Configure more advanced Web Proxy configurations, such as authentication and DNS parameters.  For more information about the <code>advancedproxyconfig</code> command, see <a href="#">Advanced Proxy Configuration, page 5-20</a> .
<code>adminaccessconfig</code>	You can configure the Web Security appliance to have stricter access requirements for administrators logging into the appliance.  For more information about the <code>adminaccessconfig</code> command, see <a href="#">Configuring Administrator Settings, page 26-15</a> .
<code>alertconfig</code>	Specify alert recipients, and set parameters for sending system alerts.
<code>authcache</code>	Allows you to delete a one or all entries (users) from the authentication cache. You can also list all users currently included in the authentication cache.  You might want to clear a user from the authentication cache so the user can login again from a different machine before the User session Restrictions values times out.
<code>bwcontrol</code>	Enable bandwidth control debug messages in the Default Proxy log file.
<code>certconfig</code>	Configure security certificates and keys.
<code>clear</code>	Clears pending configuration changes since last commit.
<code>commit</code>	Commits pending changes to the system configuration.
<code>createcomputerobject</code>	Creates a computer object at the location you specify.
<code>datasecurityconfig</code>	Defines a minimum request body size, below which upload requests are not scanned by the Cisco IronPort Data Security Filters.  For more information, see <a href="#">Bypassing Upload Requests Below a Minimum Size, page 13-2</a> .
<code>date</code>	Displays the current date. Example:  Thu Jan 10 23:13:40 2013 GMT
<code>dnsconfig</code>	Configure DNS server parameters.

**Table 27-1** Web Security appliance Administrative Commands (continued)

dnsflush	Flush DNS entries on the appliance.
etherconfig	Configure Ethernet port connections.
externaldlpconfig	Defines a minimum request body size, below which upload requests are not scanned by the external DLP server. For more information, see <a href="#">Bypassing Upload Requests Below a Minimum Size, page 13-2</a> .
featurekey	Submits valid keys to activate licensed features. For more information, see <a href="#">Feature Keys Page, page 26-7</a> .
featurekeyconfig	Automatically check for and update feature keys. For more information, see <a href="#">Feature Key Settings Page, page 26-7</a> .
grep	Searches named input files for lines containing a match to the given pattern.
help	Returns a list of commands.
iccm_message	Clears the message in the web interface and CLI that indicates when this Web Security appliance is managed by a Security Management appliance (M-Series).
ifconfig or interfaceconfig	Configure and manage network interfaces including M1, P1, and P2. Displays currently configured interfaces, and provides an operations menu to create, edit, or delete interfaces.
last	Lists user-specific user information that includes ttys and hosts, in reverse time order or lists the users that are logged in at a specified date and time.
loadconfig	Load a system configuration file.
logconfig	Configure access to log files.
mailconfig	Mail the current configuration file to the address specified.
musconfig	Use this command to enable Secure Mobility and configure how to identify remote users, either by IP address or by integrating with one or more Cisco adaptive security appliances. <b>Note:</b> Changes made using this command cause the Web Proxy to restart. For more information on enabling and configuring Secure Mobility, see <a href="#">Enabling Secure Mobility, page 14-2</a> .

**Table 27-1 Web Security appliance Administrative Commands (continued)**

<code>musstatus</code>	Use this command to display information related to Secure Mobility when the Web Security appliance is integrated with an adaptive security appliance.  This command displays the following information: <ul style="list-style-type: none"> <li>• The status of the Web Security appliance connection with each adaptive security appliance.</li> <li>• The duration of the Web Security appliance connection with each adaptive security appliance in minutes.</li> <li>• The number of remote clients from each adaptive security appliance.</li> <li>• The number of remote clients being serviced, which is defined as the number of remote clients that have passed traffic through the Web Security appliance.</li> <li>• The total number of remote clients.</li> </ul>
<code>nslookup</code>	Queries Internet domain name servers for information about specified hosts and domains or to print a list of hosts in a domain.
<code>ntpconfig</code>	Configure NTP servers. Displays currently configured interfaces, and provides an operations menu to add, remove, or set the interface from whose IP address NTP queries should originate.
<code>packetcapture</code>	Intercepts and displays TCP/IP and other packets being transmitted or received over the network to which the appliance is attached.  For more information, see <a href="#">Packet Capture, page 26-4</a> .
<code>passwd</code>	Set the password.
<code>pathmtudiscovery</code>	Enables or disables Path MTU Discovery.  You might want to disable Path MTU Discovery if you need to packet fragmentation.
<code>ping</code>	Sends an ICMP ECHO REQUEST to the specified host or gateway.
<code>proxyconfig</code> <enable   disable>	Enables or disables the Web Proxy.
<code>proxystat</code>	Display web proxy statistics.
<code>quit, q, exit</code>	Terminates an active process or session.
<code>reboot</code>	Flushes the file system cache to disk, halts all running processes, and restarts the system.
<code>reportingconfig</code>	Configure a reporting system.
<code>resetconfig</code>	Restores the configuration to factory defaults.
<code>rollovernow</code>	Roll over a log file.
<code>routeconfig</code>	Configure destination IP addresses and gateways for traffic. Displays currently configured routes, and provides an operations menu to create, edit, or delete, or clear entries.
<code>saveconfig</code>	Saves a copy of the current configuration settings to a file. This file can be used to restore defaults, if necessary.
<code>setgateway</code>	Configure the default gateway for the machine.

**Table 27-1** Web Security appliance Administrative Commands (continued)

sethostname	Set the hostname parameter.
setntlmsecuritymode	Changes the security setting for the NTLM authentication realm to either “ads” or “domain.”  When the setting is “domain,” the appliance joins the Active Directory domain with a domain security trust account, and when the setting is “ads,” it joins the domain as a native Active Directory member. Default is ads.
settime	Set system time.
settz	Displays the current time zone and the time zone version. Provides an operations menu to set a local time zone.
showconfig	Display all configuration values. <b>Note:</b> User passwords are encrypted.
shutdown	Terminates connections and shuts down the system.
smtprelay	Configure SMTP relay hosts for internally generated email. An SMTP relay host is required to receive system generated email and alerts. For more information about configuring SMTP relay hosts, see <a href="#">Configuring SMTP Relay Hosts, page 25-16</a> .
snmpconfig	Configure the local host to listen for SNMP queries and allow SNMP requests.
sshconfig	Configure hostname and host key options for trusted servers.
status	Displays system status.
supportrequest	Send the support request email to Cisco IronPort Customer Support. This includes system information and a copy of the master configuration.
tail	Displays the end of a log file. Command accepts log file name or number as parameters.  example.com> tail system_logs  example.com> tail 9
tcpervices	Displays information about open TCP/IP services.
techsupport	Provides a temporary connection to allow Cisco IronPort Customer Support to access the system and assist in troubleshooting.
telnet	Communicates with another host using the TELNET protocol.

**Table 27-1** Web Security appliance Administrative Commands (continued)

testauthconfig	<p>Tests the authentication settings for a given authentication realm against the authentication servers defined in the realm.</p> <pre>testauthconfig [-d level] [realm name]</pre> <p>Running the command without any option causes the appliance to list the configured authentication realms from which you can make a selection.</p> <p>The debug flag (-d) controls the level of debug information. The levels can range between 0-10. If unspecified, the appliance uses a level of 0. With level 0, the command will return success or failure. If the test settings fail, the command will list the cause of the failure.</p> <p> <b>Note</b> Cisco recommends you use level 0. Only use a different debug level when you need more detailed information to troubleshoot.</p>
traceroute	Traces IP packets through gateways and along the path to a destination host.
updateconfig	Configure update and upgrade settings. For more information, see <a href="#">Configuring Upgrade and Service Update Settings, page 26-36</a> .
updatenow	Update all components.
upgrade	Install an AsyncOS software upgrade.
userconfig	Configure system administrators.
version	Displays general system information, installed versions of system software, and rule definitions.
webcache	<p>Examine or modify the contents of the proxy cache, or configure domains and URLs that the appliance never caches. Allows an administrator to remove a particular URL from the proxy cache or specify which domains or URLs to never store in the proxy cache.</p> <p>For more information, see <a href="#">Web Proxy Cache, page 5-3</a>.</p>
who	Displays who is logged into the system.
whoami	Displays user information.

# 28

## Common Tasks

---

- [Preventing Users from Accessing Streaming Media Websites During Business Hours, page 28-2](#)
- [Bypassing Authentication for Specific User Agents, page 28-4](#)
- [Bypassing Authentication for Specific Websites, page 28-5](#)
- [Bypassing Decryption for specific HTTPS Websites, page 28-7](#)
- [Bypassing Web Reputation Filtering without Bypassing Anti-Malware Scanning, page 28-9](#)
- [Creating Access Policies for Active Directory User Groups, page 28-11](#)
- [Automating Log File Transfers, page 28-13](#)
- [Redirecting Web Traffic, page 28-14](#)

# Preventing Users from Accessing Streaming Media Websites During Business Hours

In this task, you will prevent all users from accessing streaming media websites during your business hours, which you define as 8 am to 5 pm, Monday through Friday. However, you will allow them access during the lunch hour, from noon to 1 pm. You might want to do this to reduce overall bandwidth usage during work hours so there is sufficient capacity to accomplish work related tasks.

For example, a significant number of employees have complained about slow network speeds when trying to access SalesForce.com. Meanwhile your IT administrator has pointed out that 30% of employees access streaming music during business hours. By blocking streaming music during business hours only, you can increase bandwidth to allow employees to access work related sites like SalesForce.com more quickly, while still allowing employees to access all sites during non-critical business times.

This task assumes you already have defined an Identity Policy for the users you want to prevent from accessing streaming media websites.

- 
- Step 1** Navigate to the Web Security Manager > Defined Time Ranges page.
  - Step 2** Click **Add Time Range**.
  - Step 3** In the Time Range Name field, enter a name for this range of times you will configure, such as **Business Hours**.
  - Step 4** In the Time Zone section, choose “Use Time Zone Setting from Appliance”.
  - Step 5** In the Time Values area, Day of Week section, select the following check boxes:  
Monday, Tuesday, Wednesday, Thursday, Friday
  - Step 6** In the Time Values area, Time of Day section, enter **8:00** in the From field, and enter **12:00** in the To field.
  - Step 7** Click **Add Row** to create an additional time value row.
  - Step 8** In the Day of Week section of the new row, check the following check boxes:  
Monday, Tuesday, Wednesday, Thursday, Friday
  - Step 9** In the Time of Day section of the new row, enter **13:00** in the From field, and enter **17:00** in the To field.
  - Step 10** Click **Submit**.
  - Step 11** Navigate to the Web Security Manager > Access Policies page.
  - Step 12** Click **Add Policy**.
  - Step 13** In the Policy Name field, enter a policy name, such as **BlockStreamingMedia**.
  - Step 14** In the Insert Above Policy field, place the Access Policy group above the current top most policy group.
  - Step 15** In the Identities and Users section, choose “Select one or More Identities” in the dropdown field.
  - Step 16** In the Identity field, choose the Identity group that corresponds to the users you want to block from accessing streaming media websites.
  - Step 17** If the Identity requires authentication, specify which users are authorized for this policy group, such as all authenticated users.
  - Step 18** Click **Submit**.
  - Step 19** Click the link under the URL Filtering column for the Access Policy you just created.



- Step 20** In the Predefined URL Category Filtering section, click Time-Based for the Streaming Media URL category.
- When you select Time-Based for the URL category, additional fields appear under the category name where you can choose the actions.
- Step 21** In the In Time Range field, choose **BusinessHours**.
- Step 22** In the Action field, choose **Block**.
- Step 23** In the Otherwise field, choose **Monitor**.
- Step 24** Submit and Commit your changes.
- 

Now, when users try to access websites that contain streaming media applications during business hours, such as youtube.com, they will be blocked and will see an end-user notification page displaying the reason for the block.

### Where to Find More Information

You can read the following sections for more detailed information on the steps included in this task:

- [Filtering Transactions Using URL Categories, page 17-9](#)
- [Creating Time Based URL Filters, page 17-21](#)
- [Working with Time Based Policies, page 7-9](#)

# Bypassing Authentication for Specific User Agents

In this task, you will make sure the Web Proxy does not authenticate requests from particular user agents on the network. You might want to do this to for user agents that cannot prompt end users for their authentication credentials. In particular, this task will bypass authentication for all applications that access the Web on the iPhone, iPad, and iPod.

This task assumes one or more authentication realms are already defined on the Web Security appliance.

- 
- Step 1** Navigate to the Web Security Manager > Identities page.
  - Step 2** Click Add Identity.
  - Step 3** In the Name field, enter a name for this policy, such as **UserAgentsToBypass**.
  - Step 4** In the Insert Above field, verify this Identity is above all other Identities that require authentication.
  - Step 5** Under Membership Definition, click **Advanced** to expand the advanced policy options.
  - Step 6** Click the link next to User Agents.
  - Step 7** On the Identities: Policy “UserAgentsToBypass”: Membership by User Agent page, in the Common User Agents section, click **Others** to expand the other user agents.
  - Step 8** Select the Microsoft Windows Update check box.
  - Step 9** In the Customer User Agents field, enter the following entries:
    - iPhone
    - iPad
    - iPod
  - Step 10** Click **Done**.
  - Step 11** Click **Submit**.
  - Step 12** Navigate to the Web Security Manager > Access Policies page.
  - Step 13** Click **Add Policy**.
  - Step 14** In the Policy Name field, enter a name for this policy, such as **APBypassAuthUserAgents**.
  - Step 15** In the Identities and Users field, choose “Select One or More Identities.”
  - Step 16** In the Identity field, select the Identity created in [Step 3](#).
  - Step 17** Submit and Commit your changes.
- 

When an application on the iPhone, iPad, or iPod tries to access the Web, it succeeds and does not prompt users for their username and password.



#### Note

You can add the %u custom field to the access logs to see which user agents try to access the Web.

---

## Where to Find More Information

You can read the following sections for more detailed information on the steps included in this task:

- [Working with User Agent Based Policies, page 7-10](#)
- [Creating Identities, page 8-18](#)

# Bypassing Authentication for Specific Websites

In this task, you will make sure the Web Proxy does not authenticate requests from users trying to access specific websites. You might want to do this to for websites that do not interact properly with proxy servers that authenticate their users, but you still want the Web Proxy to apply security services to the website, such as web reputation filtering and anti-malware scanning. Also, you might want to do this for websites that multiple user agents need to access, but the user agents cannot prompt users to enter authentication credentials, such as Microsoft Windows updater user agents.

For example, users have been complaining about not being able to access files they need for work hosted on a partner website. They can access the files on the partner's website when they are not connected to the local network, but cannot access the partner's website when they are connected to the local network. IT has learned from reading the Web Security appliance access logs that the partner's web server is not fully RFC compliant with HTTP and cannot communicate properly with the Web Proxy when it authenticates its end users. By not authenticating users that access the partner's website, you can still allow access while protecting users by scanning the content downloaded from the server.

Additionally, on Windows machines, the Microsoft Windows updater fails by either hanging or displaying an error message to end users.

This task assumes one or more authentication realms are already defined on the Web Security appliance.

- 
- Step 1** Navigate to the Web Security Manager > Custom URL Categories page.
- Step 2** On the Customer URL Categories page, click **Add Custom Category**.
- Step 3** In the Category Name field, enter a name for this category, such as **BypassAuth**.
- Step 4** In the Sites field, enter the addresses for the websites you want to have bypassed for authentication. In this task, enter the following addresses:
- mypartnersite.com
  - .mypartnersite.com
  - download.windowsupdate.com
  - .windowsupdate.microsoft.com
  - .update.microsoft.com
  - .download.windowsupdate.com
  - update.microsoft.com
  - .windowsupdate.com
  - download.microsoft.com
  - windowsupdate.microsoft.com
  - ntservicepack.microsoft.com
  - wustat.windows.com
  - c.microsoft.com
- Step 5** Click **Submit**.
- Step 6** Navigate to the Web Security Manager > Identities page.
- Step 7** Click **Add Identity**.
- Step 8** In the Name field, enter a name for this policy, such as **WebsitesToBypassAuth**.

- Step 9** In the Insert Above field, verify this Identity is above all other Identities that require authentication and below all Identities that do not require authentication.
- Step 10** Under Membership Definition, click **Advanced** to expand the advanced policy options.
- Step 11** Click the link next to URL Categories.
- Step 12** On the Identities: Policy “WebsitesToBypassAuth”: Membership by URL Categories page, in the Custom URL Categories section, click in the Add column for the custom URL category created in [Step 3](#).
- Step 13** Click **Done**.
- Step 14** Click **Submit**.
- Step 15** Navigate to the Web Security Manager > Access Policies page.
- Step 16** Click **Add Policy**.
- Step 17** In the Policy Name field, enter a name for this policy, such as **APBypassAuthWebsites**.
- Step 18** In the Identities and Users field, choose “Select One or More Identities.”
- Step 19** In the Identity field, select the Identity created in [Step 8](#).
- Step 20** Submit and Commit your changes.
- 

Now, Microsoft Windows updater running on each client machine will be able to access the multiple Microsoft servers listed in [Step 4](#) to receive Windows updates. Additionally, when users try to access the partner website listed in [Step 4](#) ([mypartnersite.com](http://mypartnersite.com)), they are able to view the site with no problem and without being prompted for their username and password.

### Where to Find More Information

You can read the following sections for more detailed information on the steps included in this task:

- [Creating and Editing Custom URL Categories, page 17-15](#)
- [Creating Identities, page 8-18](#)
- [Bypassing Authentication, page 20-28](#)

# Bypassing Decryption for specific HTTPS Websites

In this task, you will pass through traffic to specific HTTPS websites. You might want to do this to allow users to access the HTTPS website, while still inspecting traffic to other websites.

Some websites and web-based applications that use HTTPS do not work when the Web Security appliance decrypts the traffic between the client and the server. If you trust these HTTPS websites, you can configure the appliance to pass through traffic from clients to the HTTPS servers instead of decrypting the traffic to inspect for malware and to enforce acceptable use policies.

For example, users have been complaining about not being able to access a partner website that uses HTTPS while connected to the local network. IT has learned from reading the Web Security appliance access logs that the partner's HTTPS server is not fully RFC compliant with HTTPS and cannot communicate properly with the HTTPS Proxy when it decrypts traffic between clients and the HTTPS server. By bypassing all HTTPS traffic to the partner's website, you can still allow access while decrypting traffic to other HTTPS servers.

This task assumes that the HTTPS Proxy is enabled and decrypts traffic by default.

- 
- Step 1** Navigate to the Web Security Manager > Custom URL Categories page.
  - Step 2** On the Customer URL Categories page, click **Add Custom Category**.
  - Step 3** In the Category Name field, enter a name for this category, such as **HTTPSPassThru**.
  - Step 4** In the Sites field, enter the addresses for the websites you want to bypass decryption, such as **mypartnersite.com**
  - Step 5** Click **Submit**.
  - Step 6** Navigate to the Web Security Manager > Identities page.
  - Step 7** Click **Add Identity**.
  - Step 8** In the Name field, enter a name for this policy, such as **WebsitesToBypassDecryption**.
  - Step 9** Under Membership Definition, click **Advanced** to expand the advanced policy options.
  - Step 10** Click the link next to URL Categories.
  - Step 11** On the Identities: Policy “WebsitesToBypassDecryption”: Membership by URL Categories page, in the Custom URL Categories section, click in the Add column for the custom URL category created in [Step 3](#).
  - Step 12** Click **Done**.
  - Step 13** Click **Submit**.
  - Step 14** Navigate to the Web Security Manager > Decryption Policies page.
  - Step 15** Click **Add Policy**.
  - Step 16** In the Name field, enter a name for this policy, such as **DPPassThrough**.
  - Step 17** In the Identities and Users field, choose “Select One or More Identities.”
  - Step 18** In the Identity field, select the Identity created in [Step 8](#).
  - Step 19** Submit and Commit your changes.
- 

Now, when users try to access the websites listed in [Step 4](#), they are able to view sites with no problem while still decrypting traffic for other sites.

## Where to Find More Information

You can read the following sections for more detailed information on the steps included in this task:

- [Creating and Editing Custom URL Categories, page 17-15](#)
- [Creating Identities, page 8-18](#)
- [Enabling the HTTPS Proxy, page 11-13](#)
- [Creating Decryption Policies, page 11-16](#)

# Bypassing Web Reputation Filtering without Bypassing Anti-Malware Scanning

In this task, you will bypass Web Reputation filtering for some websites while still ensuring the content downloaded from these sites is scanned for malware. You might want to do this to allow access to particular websites your organization must work with that have very low web reputation scores (scores below the configured default score threshold for blocking, such as -6.0). However, you still want to protect users from malware, so you want to ensure that the sites are scanned by the anti-malware scanning engines.

For example, your customer's website runs on a server with an IP address that also runs irreputable domains, thereby lowering your customer's overall reputation score. Your IT department has confirmed that your organization trusts the customer's website enough to allow users to access it. By bypassing web reputation filtering for the customer's domain, you can still allow users to access it while scanning downloaded content for malware.

This task assumes:

- The Adaptive Scanning feature is not enabled. When Adaptive Scanning is enabled, you cannot configure web reputation score thresholds.
- You have a list of addresses that you want to bypass for Web Reputation filtering. In this task, you will bypass Web Reputation filtering for the fictitious site `mylowreputationsite.com`.
- You want to block all websites with a web reputation score of -7.0 or less. That is, the websites you want to bypass Web Reputation Filtering have a score higher than -7.0.

- 
- Step 1** Navigate to the Web Security Manager > Custom URL Categories page.
- Step 2** On the Customer URL Categories page, click **Add Custom Category**.
- Step 3** In the Category Name field, enter a name for this category, such as `BypassWebRep`.
- Step 4** In the Sites field, enter the addresses for the websites you want to have bypassed for Web Reputation filtering. In this task, enter the following addresses:
- `mylowreputationsite.com`
  - Any other website that has a web reputation score greater than -7.0 that you want to access.
- Step 5** Click **Submit**.
- Step 6** Navigate to the Web Security Manager > Identities page.
- Step 7** Click **Add Identity**.
- Step 8** In the Name field, enter a name for this policy, such as `WebsitesToBypassWebRep`.
- Step 9** Under Membership Definition, click **Advanced** to expand the advanced policy options.
- Step 10** Click the link next to URL Categories.
- Step 11** On the Identities: Policy “WebsitesToBypassWebRep”: Membership by URL Categories page, in the Custom URL Categories section, click in the Add column for the custom URL category created in [Step 3](#).
- Step 12** Click **Done**.
- Step 13** Click **Submit**.
- Step 14** Navigate to the Web Security Manager > Access Policies page.
- Step 15** Click **Add Policy**.
- Step 16** In the Policy Name field, enter a name for this policy, such as `APBypassWebRep`.

- Step 17** In the Identities and Users field, choose “Select One or More Identities.”
- Step 18** In the Identity field, select the Identity created in [Step 8](#).
- Step 19** Click **Submit**.
- Step 20** On the Access Policies page, click the Web Reputation and Anti-Malware Filtering link for the Access Policy you created in [Step 16](#).
- Step 21** Under the “Web Reputation and Anti-Malware Settings” section, choose Define Web Reputation and Anti-Malware Custom Settings if it is not chosen already.
- Step 22** Move the left marker to -7.0 to change the score threshold for blocking URLs.
- Step 23** Submit and Commit your changes.
- 

Now, when users try to access the website in [Step 4](#), they should be able to access it (instead of seeing an end-user notification page informing them that it was blocked due to web reputation) as long as the current score is greater than -7.0 and that no malware was found during scanning.

### Where to Find More Information

You can read the following sections for more detailed information on the steps included in this task:

- [Creating and Editing Custom URL Categories, page 17-15](#)
- [Creating Identities, page 8-18](#)
- [Web Reputation and Anti-Malware Settings in Access Policies, page 19-11](#)
- [Configuring Web Reputation Scores, page 19-13](#)



# Creating Access Policies for Active Directory User Groups

You might want to grant different levels of access control to different users. For example, you might need to allow marketing users to access partner websites, but block engineering users from accessing partner sites. When users are authenticated against an authentication server, such as Microsoft Active Directory, and the authentication server has different user groups defined, you can create different policies for different user groups.

In this task, you will create two Access Policies that apply to users in different Active Directory user groups. One policy will be for Marketing users and the other for Engineering users.

This task assumes that an NTLM authentication realm is defined on the Web Security appliance that references an Active Directory server with configured user groups.

- 
- Step 1** Navigate to the Web Security Manager > Identities page.
  - Step 2** Click **Add Identity**.
  - Step 3** In the Name field, enter a name for this policy, such as **NTLMUsers**.
  - Step 4** In the Insert Above field, verify this Identity is below all other Identities that do not require authentication.
  - Step 5** In the Define Members by Authentication section, choose “Require Authentication” from the drop down menu.
  - Step 6** In the Select a Realm or Sequence field, choose the NTLM authentication realm already defined on the appliance.
  - Step 7** In the Define Members by Protocol section, choose “HTTP/HTTPS Only.” This is because authentication is not supported with native FTP transactions.
  - Step 8** Use the default values for all other settings, or optionally, change them as needed by your organization.
  - Step 9** Click **Submit**.
  - Step 10** Navigate to the Web Security Manager > Access Policies page.
  - Step 11** Click **Add Policy**.
  - Step 12** In the Policy Name field, enter a name for this policy, such as **MarketingPolicy**.
  - Step 13** In the Identities and Users field, choose “Select One or More Identities.”
  - Step 14** In the Identity field, select the Identity created in [Step 3](#).
  - Step 15** Under Authorized Users and Groups for the NTLM authentication realm, choose “Selected Groups and Users” and then click the link next to “Groups.”
  - Step 16** On the Access Policies: Policy “PolicyName”: Edit Groups page, add user groups to the Authorized Groups section. You can do this using any of the following methods:
    - Select a user group in the directory search list window and either double-click or click **Add**.
    - Type the entire group name in the Directory Search window, and after the search is complete, click **Add**. This allows you to enter groups that do not appear in the directory search list, such as groups that belong to a trusted domain or groups that are not yet available in the directory.
  - Step 17** Click **Done**.
  - Step 18** Click **Submit**.
  - Step 19** Repeat [Step 11](#) through [Step 18](#) using a different Access Policy name, such as **EngineeringPolicy** and specifying different Active Directory user groups.

- Step 20** On the Access Policies page, configure access control settings for each Access Policy as desired.
- Step 21** Submit your changes.
- 

Now, users from the set of users defined in [Step 16](#) will have different Access Policies applied to them than the users defined in [Step 19](#). Assuming you configure different access control settings for each Access Policy, each set of users will observe different behavior when accessing the web.

### Where to Find More Information

You can read the following sections for more detailed information on the steps included in this task:

- [Creating Identities, page 8-18](#)
- [Configuring Identities in Other Policy Groups, page 8-22](#)

# Automating Log File Transfers

In this task, you will configure the appliance so it automatically transfers the access logs using SCP to a remote server every day at noon and midnight. You might want to do this if you want each log file to contain web access information for the same amount of time (12 hours).

For example, you use a third party tool to analyze the web data in the access logs each day, and you want each access log file to contain data for the exact same amount of time, 12 hours.

This task assumes you have access to an SCP server, including the host name, directory, and username.

- 
- Step 1** Navigate to the System Administration > Log Subscriptions page.
- Step 2** Click the “accesslogs” link under the Log Name column.
- Step 3** On the Edit Log Subscription page, in the Rollover by Time field, choose “Daily Rollover.”
- Step 4** In the Time of Day field, enter the following text:

00:00, 12:00



---

**Note** You can automatically transfer log files multiple times a day by entering multiple times separated by a comma.

---

- Step 5** In the Retrieval Method section, choose “SCP on Remote Server.”
- Step 6** Enter the required SCP server information, such as SCP host name and username.
- Step 7** Leave other settings as is, or change as desired.
- Step 8** Submit and commit your changes.
- 

Now, AsyncOS for Web transfer the newly saved log file to the SCP server each day at noon and midnight. For more details on the tasks AsyncOS for Web performs when it rolls over a log file, see [Rolling Over Log Subscriptions, page 24-8](#).

## Where to Find More Information

You can read the following sections for more detailed information on the steps included in this task:

- [Working with Log Subscriptions, page 24-7](#)
- [Rolling Over Log Subscriptions, page 24-8](#)

# Redirecting Web Traffic

You can use the Cisco IronPort Web Security Appliance to redirect users to a different website. You can configure the appliance to redirect traffic originally destined for a URL in a custom URL category to a location you specify. This allows you to redirect traffic on the appliance instead of at the destination server.

For example, the Benefits department owns an internal webpage that includes links for users to view and edit their benefits information, such as health insurance provider. The Benefits department sent an email to users announcing the benefits enrollment deadline several weeks in advance. However, they needed to change the location of their webpage a few days before the benefits enrollment deadline. Instead of sending a new email to all users, you can use the Web Security appliance to redirect users from the original URL to the new and correct URL.

In this task, you will redirect traffic for an internal server to a different internal server.

- 
- Step 1** Navigate to the Web Security Manager > Custom URL Categories page.
  - Step 2** On the Customer URL Categories page, click **Add Custom Category**.
  - Step 3** In the Category Name field, enter a name for this category, such as **IntranetToRedirect**.
  - Step 4** In the Sites field, enter the addresses for the websites you want to redirect to another URL. In this task, enter the following address:
    - intranet.example.com
  - Step 5** Click **Submit**.
  - Step 6** Navigate to the Web Security Manager > Access Policies page.
  - Step 7** Click **Add Policy**.
  - Step 8** In the Policy Name field, enter a name for this policy, such as **APRedirectIntranet**.
  - Step 9** In the Identities and Users field, keep the default value of “All Identities.”
  - Step 10** Click **Submit**.
  - Step 11** On the Access Policies page, click the URL Filtering link for the Access Policy you created in [Step 8](#).
  - Step 12** In the Custom URL Category Filtering section, click **Select Custom Categories**.
  - Step 13** In the Select Custom Categories for this Policy dialog box, choose “Include in policy” for the custom URL category you created in [Step 3](#).
  - Step 14** Click **Apply**.
  - Step 15** In the Custom URL Category Filtering section, click in the Redirect column for the custom URL category you just added.
  - Step 16** In the Redirect To field, enter the URL to which you want to redirect traffic originally intended for the URL in [Step 4](#), such as **internal.example.com**.
  - Step 17** Submit and commit your changes.
- 

Now, when users open a browser and try to access intranet.example.com, the browser is redirected to internal.example.com.

## Where to Find More Information

You can read the following sections for more detailed information on the steps included in this task:

- [Creating and Editing Custom URL Categories, page 17-15](#)
- [Redirecting Traffic, page 17-19](#)



# A

## HTTPS Reference

---

This appendix contains the following sections:

- [Overview of HTTPS, page A-1](#)
- [Digital Certificates, page A-5](#)
- [Decrypting HTTPS Traffic, page A-6](#)

## Overview of HTTPS

HTTPS is a web protocol that acts as a secure form of HTTP. HTTPS encrypts HTTP requests and responses before they are sent across the network. Common thinking is that any connection to a site using HTTPS is “safe.” HTTPS connections are secure, not safe, and they do not discriminate against malicious or compromised servers. HTTPS is a secure way to complete legitimate transactions, but more dangerously, it is a secure way to download malware which can infect your network.

Not being able to inspect HTTPS traffic makes the network vulnerable to the following risks:

- **Secure site hosting malware.** Spammers and phishers can create legitimate looking websites that are only reachable through an HTTPS connection. Some users may mistakenly trust the web server because it requires an HTTPS connection, resulting in intentional and unintentional downloaded malware.
- **Malware from HTTPS web applications.** Some malware can infect the network from legitimate web applications, such as secure email clients, by downloading attachments.
- **Secure anonymizing proxy.** Some web servers offer a proxy service over an HTTPS connection that allows users to circumvent acceptable use policies. When users on the network use a secure proxy server outside the network, they can access any website, regardless of its web reputation or malware content.

The appliance uses both a URL filtering engine and Web Reputation Filters to make intelligent decisions about when to decrypt HTTPS connections. With this combination, administrators and end users are not forced to make a trade-off between privacy and security.

You can define HTTPS policies that determine if an HTTPS connection can proceed without examination or whether the appliance should act as an intermediary, decrypting the data passing each way and applying Access Policies to the data as if it were a plaintext HTTP transaction.

To configure the appliance to handle HTTPS requests, you must perform the following tasks:

1. **Enable the HTTPS Proxy.** To monitor and decrypt HTTPS traffic, you must first enable the HTTPS Proxy. For more information, see [Enabling HTTPS Certificate Validation and Content Decryption, page 11-8](#).
2. **Create and configure Decryption Policy groups.** Once the HTTPS Proxy is enabled, you can create and configure Decryption Policy groups to determine how to handle each request from each user. For more information, see [Creating Decryption Policies, page 11-16](#).

- (Optional) Import custom root certificates.** Optionally, you can import one or more custom root certificates so the Web Proxy can recognize additional trusted root certificate authorities used by HTTPS servers. For more information, see [Trusted Root Certificates, page 11-22](#).

**Note**

When the HTTPS Proxy is disabled, the Web Proxy passes through explicit HTTPS connections and it drops transparently redirected HTTPS requests. The access logs contain the CONNECT requests for explicit HTTPS connections, but no entries exist for dropped transparently redirected HTTPS requests.

This book uses many terms from digital cryptography. This book also includes sections with background information about HTTPS and digital cryptography for reference only. For a list of the terms and definitions used in this book, see [Digital Cryptography Terms, page A-2](#). For an overview of HTTPS the protocol, see [HTTPS Basics, page A-3](#).

## Digital Cryptography Terms

To understand how encryption and decryption works, you need to understand a little bit about cryptographic encoding techniques. [Figure A-1](#) describes some terms used in cryptography that are discussed in this chapter.

**Table A-1**      *Cryptography Terms and Definitions*

Term	Definition
Certificate authority	An entity which issues digital certificates for use by other parties.  Certificate authorities are sometimes referred to as trusted third parties. Certificate authorities are typically commercial companies that charge for their services. However, some institutions and governments have their own certificate authorities, and some offer their services for free.
Cipher	An algorithm used for encoding and decoding text to make it unreadable to any system without the appropriate key.  Ciphers work with keys to encode or decode text.
Ciphertext	Encoded text after a cipher has been applied to it.
Digital certificate	An electronic document that identifies and describes an organization that has been verified and signed by a trusted organization called a certificate authority.  A digital certificate is similar in concept to an “identification card.” SSL uses certificates to authenticate servers.  For more information about digital certificates, see <a href="#">Digital Certificates, page A-5</a> .
Digital signature	A checksum that verifies that a message was created by the stated author and was not altered since its creation.
Key	A numeric parameter used by a cipher to encode or decode text.
Plaintext or cleartext	Message text in its original form, before it gets encoded by a cipher.



**Table A-1** *Cryptography Terms and Definitions (continued)*

<b>Term</b>	<b>Definition</b>
Public key cryptography	<p>A system that uses two different keys for encoding and decoding text where one key is publicly known and available and the other key is private.</p> <p>With public key cryptography, anyone can send an encoded message to a server that has publicized its public key, but only the recipient server can decode the message with its private key.</p> <p>This is also known as asymmetric key cryptography.</p>
Public key infrastructure (PKI)	<p>An arrangement that binds public keys with respective user identities by means of a certificate authority.</p> <p>X.509 is a standard that is an example PKI. X.509 specifies standards for public key certificates and an algorithm for validating certification paths.</p>
Private key cryptography	<p>A system that uses the same key for encoding and decoding text.</p> <p>Because both sides of the transaction need the same key, they need a secure way to communicate which key to use in a particular communication session. Usually, they set up secure communication using public key cryptography and then generate a temporary symmetric key to use for the rest of the session.</p> <p>This is also known as symmetric key cryptography.</p>
Root certificate	<p>A certificate that is the topmost certificate in a certificate tree structure.</p> <p>All certificates below the root certificate inherit the trustworthiness of the root certificate.</p> <p>Root certificates can be unsigned public key certificates or self-signed certificates.</p>
Self-signed certificate	<p>A digital certificate where the certificate authority is the same as the certificate creator.</p>

## HTTPS Basics

HTTPS is a web protocol that acts as a secure form of HTTP. HTTPS is secure because the HTTP request and response data is encrypted before it is sent across the network. HTTPS works similarly to HTTP, except that the HTTP layer is sent on top of a security layer using either Secure Sockets Layer (SSL) or Transport Layer Security (TLS). SSL and TLS are very similar, so this User Guide uses “SSL” to refer to both SSL and TLS, unless otherwise specified.

[Figure A-1](#) shows the different OSI network layers for HTTPS and HTTP. It shows that HTTPS is the HTTP protocol at the application layer over SSL or TLS at the security layer.

Figure A-1 HTTPS and HTTP OSI Layers

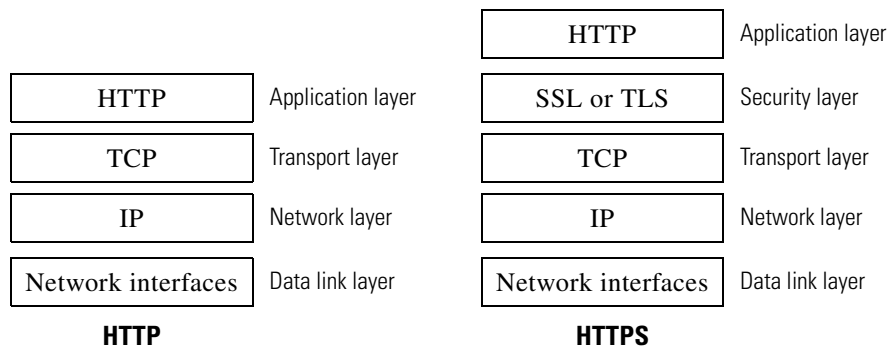

The URL typically determines whether the client application should use HTTP or HTTPS to contact a server:

- **http://servername.** The client application opens a connection to the server on port 80 by default and sends HTTP commands in plaintext.
- **https://servername.** The client application opens a connection to the server on port 443 by default and starts to engage in the SSL “handshake” to establish a secure connection between the client and server. Once the secure connection is established, the client application sends encrypted HTTP commands. For more information about the SSL handshake, see [SSL Handshake, page A-4](#).

## SSL Handshake

The SSL “handshake” is a set of steps a client and server engage in using the SSL protocol to establish a secure connection between them. The client and server must complete the following steps before they can send and receive encrypted HTTP messages:

1. **Exchange protocol version numbers.** Both sides must verify they can communicate with compatible versions of SSL or TLS.
2. **Choose a cipher that each side knows.** First, the client advertises which ciphers it supports and requests the server to send its certificate. Then, the server chooses the strongest cipher from the list and sends the client the chosen cipher and its digital certificate.
3. **Authenticate the identity of each side.** Typically, only the server gets authenticated while the client remains unauthenticated. The client validates the server certificate. For more information about certificates and using them to authenticate servers, see [Digital Certificates, page A-5](#).
4. **Generate temporary symmetric keys to encrypt the channel for this session.** The client generates a session key (usually a random number), encrypts it with the server’s public key, and sends it to the server. The server decrypts the session key with its private key. Both sides compute a common master secret key that will be used for all future encryption and decryption until the connection closes.

# Digital Certificates

A digital certificate is an electronic document that identifies and describes an organization, and that has been verified and signed by a trusted organization. A digital certificate is similar in concept to an identification card, such as a driver's license or a passport. The trusted organization that signs the certificate is also known as a certificate authority.

Certificates allow a client to know that it is talking to the organization it thinks it is talking to. When a server certificate is signed by a well-known or trusted authority, the client can better assess how much it trusts the server.

X.509 is a standard example of a public key infrastructure (PKI). X.509 specifies standards for certificates and an algorithm for validating certification paths. The Web Security appliance uses the X.509 standard.

X.509 certificates contain the following information:

- Subject's identity, such as the name of a person, server, or organization
- Certificate validity period
- Certificate authority who is vouching for the certificate
- Digital signature of the certificate created by the certificate authority using its private key
- Public key of the subject

For an example digital certificate you can view from a web browser, see [Working with Root Certificates, page A-8](#).

Although anyone can create a digital certificate, not everyone can get a well-respected certificate authority to vouch for the certificate's information and sign the certificate with its private key. For more information about validating the certificate authority in a digital certificate, see [Validating Certificate Authorities, page A-5](#).

## Validating Certificate Authorities

The X.509 standard allows certificate authorities to issue digital certificates that are signed by other certificate authorities. Due to this system, there is a hierarchy of certificate authorities in a tree structure.

The top-most certificate authorities in the tree structure are called root certificates. Root certificates are not signed by a separate certificate authority because they are at the top of the tree structure. Therefore, by definition, all root certificates are self-signed certificates. The certificate authority listed in the root certificate is the certificate creator.

All certificates below the root certificate inherit the trustworthiness of the root certificate. For example, if CertificateAuthorityABC is a trusted certificate authority and it signs the certificate for certificate authority CertificateAuthorityXYZ, then CertificateAuthorityXYZ is automatically a trusted certificate authority.

[Figure A-2](#) shows the certification path for a certificate viewed in a web browser.

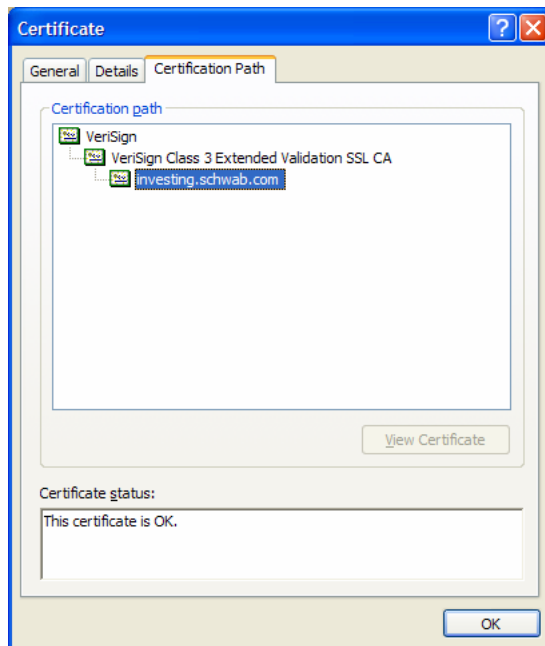
**Figure A-2 Certification Path Example**

In [Figure A-2](#), the certificate for the URL `investing.schwab.com` was signed by certificate authority “VeriSign Class 3 Extended Validation SSL CA,” which in turn was signed by certificate authority VeriSign.

By definition, root certificates are always trusted by applications that follow the X.509 standard. The Web Security appliance uses the X.509 standard.

Standard web browsers ship with a set of trusted root certificates. The list of root certificates is updated regularly. You can view the root certificates installed on the web browser.

For example, to view the root certificates installed with Mozilla Firefox 2.0, go to Tools > Options > Advanced > Encryption > View Certificates. To view the root certificates installed with Internet Explorer 7, go to Tools > Internet Options > Content > Certificates > Trusted Root Certification Authorities.

In [Figure A-2](#), the VeriSign certificate is a root certificate that shipped with the web browser.

The Web Security appliance also installs with a set of trusted root certificates. However, you can upload additional root certificates that the Web Proxy deems to be trusted. For more information about this, see [Trusted Root Certificates](#), page 11-22.

## Decrypted HTTPS Traffic

The request and response data is encrypted for HTTPS connections before it is sent across the network. Because the data is encrypted, third parties can view the data, but cannot decrypt it to read its contents without the private key of the HTTPS server.

[Figure A-3](#) shows an HTTPS connection between a client and a HTTPS server.

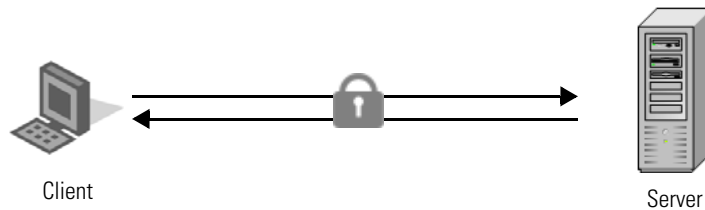
**Figure A-3** HTTPS Connection

The Web Security appliance does not have access to the server's private key, so in order to inspect the traffic between the client and the server, it must intercept the connection and break the connection into two separate connections. The appliance acts as an intermediary between the client and the server pretending to be the server to the client, and the client to the server. This is sometimes referred to as being the "man in the middle."

[Figure A-4](#) shows an HTTPS connection between a client and a HTTPS server that goes through the Web Security appliance.

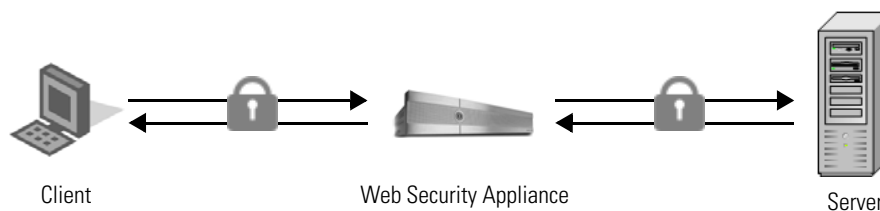
**Figure A-4** HTTPS Connection Decrypted by the Web Security Appliance

Notice that in [Figure A-4](#), there are two different HTTPS connections, one between the client and the appliance, and one between the appliance and the server. The appliance performs the SSL handshake twice, once with the client and again with the server:

- SSL handshake with the server.** When the appliance performs the SSL handshake with the server, it acts as if it were the client sending a request to the server. After it establishes a secure connection with the server, it can begin receiving the encrypted data. Because it acts as the client and participates in the SSL handshake, it has agreed upon a temporary symmetric key with the server so it can decrypt and read the data the server sends. Also, the appliance receives the server's digital certificate.
- SSL handshake with the client.** When the appliance performs the SSL handshake with the client, it acts as if it were the requested server providing data the client requests. In order to perform the SSL handshake with the client, it must send the client its own digital certificate. However, the client expects the certificate of the requested server, so the appliance mimics the requested server's certificate by specifying a root certificate authority uploaded or configured by an appliance administrator.

For more information about how the server mimics the server's certificate, see [Mimicking the Server Digital Certificate, page A-8](#).

**Note**

Because the appliance signs the server certificate with a different root certificate authority and sends that to the client, you must verify the client applications on the network recognize the root certificate authority. For more information, see [Working with Root Certificates, page A-8](#).

After the two separate HTTPS connections are established, the following actions occur:

1. Encrypted data is received from the server.
2. The temporary, symmetric key negotiated with the server is used to decrypt the data.
3. Access Policies are applied to the decrypted traffic as if it were a plaintext HTTP connection. For more information about Access Policies, see [Block, Allow or Redirect Transaction Requests, page 9-1](#).
4. Assuming the Access Policy group allows the client to receive the data, the data is encrypted using the temporary, symmetric key negotiated with the client.
5. Encrypted data is sent to the client.

**Note**

---

No decrypted data is cached. However, access logs for decrypted HTTP transactions are saved to disk.

---

## Mimicking the Server Digital Certificate

When the appliance performs the SSL handshake with the client, it mimics the server digital certificate and sends the new certificate to the client. To mimic the server digital certificate, it reuses most field values and changes some field values.

The mimicked certificate is the same as the server certificate except for the following fields:

- **Issuer.** The issuer comes from the generated or uploaded root certificate configured in the appliance.
- **Signature Algorithm.** This field is always “sha1WithRSAEncryption” or “dsaWithSHA1” depending upon on whether the root certificate the appliance uses contains an RSA or DSA key.
- **Public Key.** The appliance replaces the public key in the original certificate with a public key it generates that matches bit strength from the original certificate and for which it has a matching private key generated as well. For example, if the server certificate uses a 2048 bit RSA key, the appliance generates a new 2048 bit RSA key.
- **X509v3 Extensions.** All X509v3 extensions are removed *except* for the following:
  - Basic Constraints
  - Subject Alternative Name
  - Key Usage
  - Subject Key Identifier
  - Extended Key Usage

For example, the appliance removes the Authority Key Identifier and the Authority Information Access X509v3 extensions.

## Working with Root Certificates

The Web Security appliance mimics the HTTPS server to which a client originally sent a connection request. In order to establish a secure connection with the client pretending to be the requested server, the appliance must send a server certificate to the client signed by a root certificate authority configured in the appliance.

When you enable the HTTPS Proxy on the appliance, you can configure the root certificate information that the appliance uses to sign its server certificates.

## Converting Certificate and Key Formats

The root certificate and private key files you upload to the appliance must be in PEM format. DER format is not supported. However, you can convert certificates and keys in DER format into the PEM format before uploading them. For example, you can use OpenSSL to convert the format.

Use the following OpenSSL command to convert a DER formatted certificate file to a PEM formatted certificate file:

```
openssl x509 -inform DER -in cert_in_DER -outform PEM -out out_file_name
```

You can also convert key files in DER format into the PEM format by running a similar OpenSSL command.

For RSA keys, use the following command:

```
openssl rsa -inform DER -in key_in_DER -outform PEM -out out_file_name
```

For DSA keys, use the following command:

```
openssl dsa -inform DER -in key_in_DER -outform PEM -out out_file_name
```

For more information about using OpenSSL, see the OpenSSL documentation, or visit <http://openssl.org>.





# A

## End User License Agreement

---

### Cisco Systems End User License Agreement

**IMPORTANT: PLEASE READ THIS END USER LICENSE AGREEMENT CAREFULLY. IT IS VERY IMPORTANT THAT YOU CHECK THAT YOU ARE PURCHASING CISCO SOFTWARE OR EQUIPMENT FROM AN APPROVED SOURCE AND THAT YOU, OR THE ENTITY YOU REPRESENT (COLLECTIVELY, THE "CUSTOMER") HAVE BEEN REGISTERED AS THE END USER FOR THE PURPOSES OF THIS CISCO END USER LICENSE AGREEMENT. IF YOU ARE NOT REGISTERED AS THE END USER YOU HAVE NO LICENSE TO USE THE SOFTWARE AND THE LIMITED WARRANTY IN THIS END USER LICENSE AGREEMENT DOES NOT APPLY. ASSUMING YOU HAVE PURCHASED FROM AN APPROVED SOURCE, DOWNLOADING, INSTALLING OR USING CISCO OR CISCO-SUPPLIED SOFTWARE CONSTITUTES ACCEPTANCE OF THIS AGREEMENT.**

CISCO SYSTEMS, INC. OR ITS SUBSIDIARY LICENSING THE SOFTWARE INSTEAD OF CISCO SYSTEMS, INC. ("CISCO") IS WILLING TO LICENSE THIS SOFTWARE TO YOU ONLY UPON THE CONDITION THAT YOU PURCHASED THE SOFTWARE FROM AN APPROVED SOURCE AND THAT YOU ACCEPT ALL OF THE TERMS CONTAINED IN THIS END USER LICENSE AGREEMENT PLUS ANY ADDITIONAL LIMITATIONS ON THE LICENSE SET FORTH IN A SUPPLEMENTAL LICENSE AGREEMENT ACCOMPANYING THE PRODUCT OR AVAILABLE AT THE TIME OF YOUR ORDER (COLLECTIVELY THE "AGREEMENT"). TO THE EXTENT OF ANY CONFLICT BETWEEN THE TERMS OF THIS END USER LICENSE AGREEMENT AND ANY SUPPLEMENTAL LICENSE AGREEMENT, THE SUPPLEMENTAL LICENSE AGREEMENT SHALL APPLY. BY DOWNLOADING, INSTALLING, OR USING THE SOFTWARE, YOU ARE REPRESENTING THAT YOU PURCHASED THE SOFTWARE FROM AN APPROVED SOURCE AND BINDING YOURSELF TO THE AGREEMENT. IF YOU DO NOT AGREE TO ALL OF THE TERMS OF THE AGREEMENT, THEN CISCO IS UNWILLING TO LICENSE THE SOFTWARE TO YOU AND (A) YOU MAY NOT DOWNLOAD, INSTALL OR USE THE SOFTWARE, AND (B) YOU MAY RETURN THE SOFTWARE (INCLUDING ANY UNOPENED CD PACKAGE AND ANY WRITTEN MATERIALS) FOR A FULL REFUND, OR, IF THE SOFTWARE AND WRITTEN MATERIALS ARE SUPPLIED AS PART OF ANOTHER PRODUCT, YOU MAY RETURN THE ENTIRE PRODUCT FOR A FULL REFUND. YOUR RIGHT TO RETURN AND REFUND EXPIRES 30 DAYS AFTER PURCHASE FROM AN APPROVED SOURCE, AND APPLIES ONLY IF YOU ARE THE ORIGINAL AND REGISTERED END USER PURCHASER. FOR THE PURPOSES OF THIS END USER LICENSE AGREEMENT, AN "APPROVED SOURCE" MEANS (A) CISCO; OR (B) A DISTRIBUTOR OR SYSTEMS INTEGRATOR AUTHORIZED BY CISCO TO DISTRIBUTE / SELL CISCO EQUIPMENT, SOFTWARE AND SERVICES WITHIN YOUR TERRITORY TO END USERS; OR (C) A RESELLER AUTHORIZED BY ANY SUCH DISTRIBUTOR OR SYSTEMS INTEGRATOR IN ACCORDANCE WITH THE TERMS OF THE DISTRIBUTOR'S AGREEMENT WITH CISCO TO DISTRIBUTE / SELL THE CISCO EQUIPMENT, SOFTWARE AND SERVICES WITHIN YOUR TERRITORY TO END USERS.

*THE FOLLOWING TERMS OF THE AGREEMENT GOVERN CUSTOMER'S USE OF THE SOFTWARE (DEFINED BELOW), EXCEPT TO THE EXTENT: (A) THERE IS A SEPARATE SIGNED CONTRACT BETWEEN CUSTOMER AND CISCO GOVERNING CUSTOMER'S USE OF THE SOFTWARE, OR (B)*

*THE SOFTWARE INCLUDES A SEPARATE "CLICK-ACCEPT" LICENSE AGREEMENT OR THIRD PARTY LICENSE AGREEMENT AS PART OF THE INSTALLATION OR DOWNLOAD PROCESS GOVERNING CUSTOMER'S USE OF THE SOFTWARE. TO THE EXTENT OF A CONFLICT BETWEEN THE PROVISIONS OF THE FOREGOING DOCUMENTS, THE ORDER OF PRECEDENCE SHALL BE (1) THE SIGNED CONTRACT, (2) THE CLICK-ACCEPT AGREEMENT OR THIRD PARTY LICENSE AGREEMENT, AND (3) THE AGREEMENT. FOR PURPOSES OF THE AGREEMENT, "SOFTWARE" SHALL MEAN COMPUTER PROGRAMS, INCLUDING FIRMWARE AND COMPUTER PROGRAMS EMBEDDED IN CISCO EQUIPMENT, AS PROVIDED TO CUSTOMER BY AN APPROVED SOURCE, AND ANY UPGRADES, UPDATES, BUG FIXES OR MODIFIED VERSIONS THERETO (COLLECTIVELY, "UPGRADES"), ANY OF THE SAME WHICH HAS BEEN RELICENSED UNDER THE CISCO SOFTWARE TRANSFER AND RE-LICENSING POLICY (AS MAY BE AMENDED BY CISCO FROM TIME TO TIME) OR BACKUP COPIES OF ANY OF THE FOREGOING.*

**License.** Conditioned upon compliance with the terms and conditions of the Agreement, Cisco grants to Customer a nonexclusive and nontransferable license to use for Customer's internal business purposes the Software and the Documentation for which Customer has paid the required license fees to an Approved Source. "Documentation" means written information (whether contained in user or technical manuals, training materials, specifications or otherwise) pertaining to the Software and made available by an Approved Source with the Software in any manner (including on CD-Rom, or on-line). In order to use the Software, Customer may be required to input a registration number or product authorization key and register Customer's copy of the Software online at Cisco's website to obtain the necessary license key or license file.

Customer's license to use the Software shall be limited to, and Customer shall not use the Software in excess of, a single hardware chassis or card or such other limitations as are set forth in the applicable Supplemental License Agreement or in the applicable purchase order which has been accepted by an Approved Source and for which Customer has paid to an Approved Source the required license fee (the "Purchase Order").

Unless otherwise expressly provided in the Documentation or any applicable Supplemental License Agreement, Customer shall use the Software solely as embedded in, for execution on, or (where the applicable Documentation permits installation on non-Cisco equipment) for communication with Cisco equipment owned or leased by Customer and used for Customer's internal business purposes. No other licenses are granted by implication, estoppel or otherwise.

For evaluation or beta copies for which Cisco does not charge a license fee, the above requirement to pay license fees does not apply.

**General Limitations.** This is a license, not a transfer of title, to the Software and Documentation, and Cisco retains ownership of all copies of the Software and Documentation. Customer acknowledges that the Software and Documentation contain trade secrets of Cisco or its suppliers or licensors, including but not limited to the specific internal design and structure of individual programs and associated interface information. Except as otherwise expressly provided under the Agreement, Customer shall only use the Software in connection with the use of Cisco equipment purchased by the Customer from an Approved Source and Customer shall have no right, and Customer specifically agrees not to:

- (i) transfer, assign or sublicense its license rights to any other person or entity (other than in compliance with any Cisco relicensing/transfer policy then in force), or use the Software on Cisco equipment not purchased by the Customer from an Approved Source or on secondhand Cisco equipment, and Customer acknowledges that any attempted transfer, assignment, sublicense or use shall be void;
- (ii) make error corrections to or otherwise modify or adapt the Software or create derivative works based upon the Software, or permit third parties to do the same;

- (iii) reverse engineer or decompile, decrypt, disassemble or otherwise reduce the Software to human-readable form, except to the extent otherwise expressly permitted under applicable law notwithstanding this restriction or except to the extent that Cisco is legally required to permit such specific activity pursuant to any applicable open source license;
- (iv) publish any results of benchmark tests run on the Software;
- (v) use or permit the Software to be used to perform services for third parties, whether on a service bureau or time sharing basis or otherwise, without the express written authorization of Cisco; or
- (vi) disclose, provide, or otherwise make available trade secrets contained within the Software and Documentation in any form to any third party without the prior written consent of Cisco. Customer shall implement reasonable security measures to protect such trade secrets.

To the extent required by applicable law, and at Customer's written request, Cisco shall provide Customer with the interface information needed to achieve interoperability between the Software and another independently created program, on payment of Cisco's applicable fee, if any. Customer shall observe strict obligations of confidentiality with respect to such information and shall use such information in compliance with any applicable terms and conditions upon which Cisco makes such information available.

**Software, Upgrades and Additional Copies.** NOTWITHSTANDING ANY OTHER PROVISION OF THE AGREEMENT: (1) CUSTOMER HAS NO LICENSE OR RIGHT TO MAKE OR USE ANY ADDITIONAL COPIES OR UPGRADES UNLESS CUSTOMER, AT THE TIME OF MAKING OR ACQUIRING SUCH COPY OR UPGRADE, ALREADY HOLDS A VALID LICENSE TO THE ORIGINAL SOFTWARE AND HAS PAID THE APPLICABLE FEE TO AN APPROVED SOURCE FOR THE UPGRADE OR ADDITIONAL COPIES; (2) USE OF UPGRADES IS LIMITED TO CISCO EQUIPMENT SUPPLIED BY AN APPROVED SOURCE FOR WHICH CUSTOMER IS THE ORIGINAL END USER PURCHASER OR LESSEE OR OTHERWISE HOLDS A VALID LICENSE TO USE THE SOFTWARE WHICH IS BEING UPGRADED; AND (3) THE MAKING AND USE OF ADDITIONAL COPIES IS LIMITED TO NECESSARY BACKUP PURPOSES ONLY.

**Proprietary Notices.** Customer agrees to maintain and reproduce all copyright, proprietary, and other notices on all copies, in any form, of the Software in the same form and manner that such copyright and other proprietary notices are included on the Software. Except as expressly authorized in the Agreement, Customer shall not make any copies or duplicates of any Software without the prior written permission of Cisco.

**Term and Termination.** The Agreement and the license granted herein shall remain effective until terminated. Customer may terminate the Agreement and the license at any time by destroying all copies of Software and any Documentation. Customer's rights under the Agreement will terminate immediately without notice from Cisco if Customer fails to comply with any provision of the Agreement. Upon termination, Customer shall destroy all copies of Software and Documentation in its possession or control. All confidentiality obligations of Customer, all restrictions and limitations imposed on the Customer under the section titled "General Limitations" and all limitations of liability and disclaimers and restrictions of warranty shall survive termination of this Agreement. In addition, the provisions of the sections titled "U.S. Government End User Purchasers" and "General Terms Applicable to the Limited Warranty Statement and End User License Agreement" shall survive termination of the Agreement.

**Customer Records.** Customer grants to Cisco and its independent accountants the right to examine Customer's books, records and accounts during Customer's normal business hours to verify compliance with this Agreement. In the event such audit discloses non-compliance with this Agreement, Customer shall promptly pay to Cisco the appropriate license fees, plus the reasonable cost of conducting the audit.

**Export, Re-Export, Transfer and Use Controls.** The Software, Documentation and technology or direct products thereof (hereafter referred to as Software and Technology), supplied by Cisco under the Agreement are subject to export controls under the laws and regulations of the United States (U.S.) and

any other applicable countries' laws and regulations. Customer shall comply with such laws and regulations governing export, re-export, transfer and use of Cisco Software and Technology and will obtain all required U.S. and local authorizations, permits, or licenses. Cisco and Customer each agree to provide the other information, support documents, and assistance as may reasonably be required by the other in connection with securing authorizations or licenses. Information regarding compliance with export, re-export, transfer and use may be located at the following URL:

[http://www.cisco.com/web/about/doing\\_business/legal/global\\_export\\_trade/general\\_export/contract\\_compliance.html](http://www.cisco.com/web/about/doing_business/legal/global_export_trade/general_export/contract_compliance.html).

***U.S. Government End User Purchasers.*** The Software and Documentation qualify as "commercial items," as that term is defined at Federal Acquisition Regulation ("FAR") (48 C.F.R.) 2.101, consisting of "commercial computer software" and "commercial computer software documentation" as such terms are used in FAR 12.212. Consistent with FAR 12.212 and DoD FAR Supp. 227.7202-1 through 227.7202-4, and notwithstanding any other FAR or other contractual clause to the contrary in any agreement into which the Agreement may be incorporated, Customer may provide to Government end user or, if the Agreement is direct, Government end user will acquire, the Software and Documentation with only those rights set forth in the Agreement. Use of either the Software or Documentation or both constitutes agreement by the Government that the Software and Documentation are "commercial computer software" and "commercial computer software documentation," and constitutes acceptance of the rights and restrictions herein.

***Identified Components; Additional Terms.*** The Software may contain or be delivered with one or more components, which may include third-party components, identified by Cisco in the Documentation, readme.txt file, third-party click-accept or elsewhere (e.g. on [www.cisco.com](http://www.cisco.com)) (the "Identified Component(s)") as being subject to different license agreement terms, disclaimers of warranties, limited warranties or other terms and conditions (collectively, "Additional Terms") than those set forth herein. You agree to the applicable Additional Terms for any such Identified Component(s)."

### **Limited Warranty**

Subject to the limitations and conditions set forth herein, Cisco warrants that commencing from the date of shipment to Customer (but in case of resale by an Approved Source other than Cisco, commencing not more than ninety (90) days after original shipment by Cisco), and continuing for a period of the longer of (a) ninety (90) days or (b) the warranty period (if any) expressly set forth as applicable specifically to software in the warranty card accompanying the product of which the Software is a part (the "Product") (if any): (a) the media on which the Software is furnished will be free of defects in materials and workmanship under normal use; and (b) the Software substantially conforms to the Documentation. The date of shipment of a Product by Cisco is set forth on the packaging material in which the Product is shipped. Except for the foregoing, the Software is provided "AS IS". This limited warranty extends only to the Software purchased from an Approved Source by a Customer who is the first registered end user. Customer's sole and exclusive remedy and the entire liability of Cisco and its suppliers under this limited warranty will be (i) replacement of defective media and/or (ii) at Cisco's option, repair, replacement, or refund of the purchase price of the Software, in both cases subject to the condition that any error or defect constituting a breach of this limited warranty is reported to the Approved Source supplying the Software to Customer, within the warranty period. Cisco or the Approved Source supplying the Software to Customer may, at its option, require return of the Software and/or Documentation as a condition to the remedy. In no event does Cisco warrant that the Software is error free or that Customer will be able to operate the Software without problems or interruptions. In addition, due to the continual development of new techniques for intruding upon and attacking networks, Cisco does not warrant that the Software or any equipment, system or network on which the Software is used will be free of vulnerability to intrusion or attack.

***Restrictions.*** This warranty does not apply if the Software, Product or any other equipment upon which the Software is authorized to be used (a) has been altered, except by Cisco or its authorized representative, (b) has not been installed, operated, repaired, or maintained in accordance with

instructions supplied by Cisco, (c) has been subjected to abnormal physical or electrical stress, abnormal environmental conditions, misuse, negligence, or accident; or (d) is licensed for beta, evaluation, testing or demonstration purposes. The Software warranty also does not apply to (e) any temporary Software modules; (f) any Software not posted on Cisco's Software Center; (g) any Software that Cisco expressly provides on an "AS IS" basis on Cisco's Software Center; (h) any Software for which an Approved Source does not receive a license fee; and (i) Software supplied by any third party which is not an Approved Source.

#### **DISCLAIMER OF WARRANTY**

**EXCEPT AS SPECIFIED IN THIS WARRANTY SECTION, ALL EXPRESS OR IMPLIED CONDITIONS, REPRESENTATIONS, AND WARRANTIES INCLUDING, WITHOUT LIMITATION, ANY IMPLIED WARRANTY OR CONDITION OF MERCHANTABILITY, FITNESS FOR A PARTICULAR PURPOSE, NON-INFRINGEMENT, SATISFACTORY QUALITY, NON-INTERFERENCE, ACCURACY OF INFORMATIONAL CONTENT, OR ARISING FROM A COURSE OF DEALING, LAW, USAGE, OR TRADE PRACTICE, ARE HEREBY EXCLUDED TO THE EXTENT ALLOWED BY APPLICABLE LAW AND ARE EXPRESSLY DISCLAIMED BY CISCO, ITS SUPPLIERS AND LICENSORS. TO THE EXTENT THAT ANY OF THE SAME CANNOT BE EXCLUDED, SUCH IMPLIED CONDITION, REPRESENTATION AND/OR WARRANTY IS LIMITED IN DURATION TO THE EXPRESS WARRANTY PERIOD REFERRED TO IN THE "LIMITED WARRANTY" SECTION ABOVE. BECAUSE SOME STATES OR JURISDICTIONS DO NOT ALLOW LIMITATIONS ON HOW LONG AN IMPLIED WARRANTY LASTS, THE ABOVE LIMITATION MAY NOT APPLY IN SUCH STATES. THIS WARRANTY GIVES CUSTOMER SPECIFIC LEGAL RIGHTS, AND CUSTOMER MAY ALSO HAVE OTHER RIGHTS WHICH VARY FROM JURISDICTION TO JURISDICTION.** This disclaimer and exclusion shall apply even if the express warranty set forth above fails of its essential purpose.

*Disclaimer of Liabilities - Limitation of Liability.* IF YOU ACQUIRED THE SOFTWARE IN THE UNITED STATES, LATIN AMERICA, CANADA, JAPAN OR THE CARIBBEAN, NOTWITHSTANDING ANYTHING ELSE IN THE AGREEMENT TO THE CONTRARY, ALL LIABILITY OF CISCO, ITS AFFILIATES, OFFICERS, DIRECTORS, EMPLOYEES, AGENTS, SUPPLIERS AND LICENSORS COLLECTIVELY, TO CUSTOMER, WHETHER IN CONTRACT, TORT (INCLUDING NEGLIGENCE), BREACH OF WARRANTY OR OTHERWISE, SHALL NOT EXCEED THE PRICE PAID BY CUSTOMER TO ANY APPROVED SOURCE FOR THE SOFTWARE THAT GAVE RISE TO THE CLAIM OR IF THE SOFTWARE IS PART OF ANOTHER PRODUCT, THE PRICE PAID FOR SUCH OTHER PRODUCT. THIS LIMITATION OF LIABILITY FOR SOFTWARE IS CUMULATIVE AND NOT PER INCIDENT (I.E. THE EXISTENCE OF TWO OR MORE CLAIMS WILL NOT ENLARGE THIS LIMIT).

IF YOU ACQUIRED THE SOFTWARE IN EUROPE, THE MIDDLE EAST, AFRICA, ASIA OR OCEANIA, NOTWITHSTANDING ANYTHING ELSE IN THE AGREEMENT TO THE CONTRARY, ALL LIABILITY OF CISCO, ITS AFFILIATES, OFFICERS, DIRECTORS, EMPLOYEES, AGENTS, SUPPLIERS AND LICENSORS COLLECTIVELY, TO CUSTOMER, WHETHER IN CONTRACT, TORT (INCLUDING NEGLIGENCE), BREACH OF WARRANTY OR OTHERWISE, SHALL NOT EXCEED THE PRICE PAID BY CUSTOMER TO CISCO FOR THE SOFTWARE THAT GAVE RISE TO THE CLAIM OR IF THE SOFTWARE IS PART OF ANOTHER PRODUCT, THE PRICE PAID FOR SUCH OTHER PRODUCT. THIS LIMITATION OF LIABILITY FOR SOFTWARE IS CUMULATIVE AND NOT PER INCIDENT (I.E. THE EXISTENCE OF TWO OR MORE CLAIMS WILL NOT ENLARGE THIS LIMIT). NOTHING IN THE AGREEMENT SHALL LIMIT (I) THE LIABILITY OF CISCO, ITS AFFILIATES, OFFICERS, DIRECTORS, EMPLOYEES, AGENTS, SUPPLIERS AND LICENSORS TO CUSTOMER FOR PERSONAL INJURY OR DEATH CAUSED BY THEIR NEGLIGENCE, (II) CISCO'S LIABILITY FOR FRAUDULENT MISREPRESENTATION, OR (III) ANY LIABILITY OF CISCO WHICH CANNOT BE EXCLUDED UNDER APPLICABLE LAW.

***Disclaimer of Liabilities - Waiver of Consequential Damages and Other Losses.*** IF YOU ACQUIRED THE SOFTWARE IN THE UNITED STATES, LATIN AMERICA, THE CARIBBEAN OR CANADA, REGARDLESS OF WHETHER ANY REMEDY SET FORTH HEREIN FAILS OF ITS ESSENTIAL PURPOSE OR OTHERWISE, IN NO EVENT WILL CISCO OR ITS SUPPLIERS BE LIABLE FOR ANY LOST REVENUE, PROFIT, OR LOST OR DAMAGED DATA, BUSINESS INTERRUPTION, LOSS OF CAPITAL, OR FOR SPECIAL, INDIRECT, CONSEQUENTIAL, INCIDENTAL, OR PUNITIVE DAMAGES HOWEVER CAUSED AND REGARDLESS OF THE THEORY OF LIABILITY OR WHETHER ARISING OUT OF THE USE OF OR INABILITY TO USE SOFTWARE OR OTHERWISE AND EVEN IF CISCO OR ITS SUPPLIERS OR LICENSORS HAVE BEEN ADVISED OF THE POSSIBILITY OF SUCH DAMAGES. BECAUSE SOME STATES OR JURISDICTIONS DO NOT ALLOW LIMITATION OR EXCLUSION OF CONSEQUENTIAL OR INCIDENTAL DAMAGES, THE ABOVE LIMITATION MAY NOT APPLY TO YOU.

IF YOU ACQUIRED THE SOFTWARE IN JAPAN, EXCEPT FOR LIABILITY ARISING OUT OF OR IN CONNECTION WITH DEATH OR PERSONAL INJURY, FRAUDULENT MISREPRESENTATION, AND REGARDLESS OF WHETHER ANY REMEDY SET FORTH HEREIN FAILS OF ITS ESSENTIAL PURPOSE OR OTHERWISE, IN NO EVENT WILL CISCO, ITS AFFILIATES, OFFICERS, DIRECTORS, EMPLOYEES, AGENTS, SUPPLIERS AND LICENSORS BE LIABLE FOR ANY LOST REVENUE, PROFIT, OR LOST OR DAMAGED DATA, BUSINESS INTERRUPTION, LOSS OF CAPITAL, OR FOR SPECIAL, INDIRECT, CONSEQUENTIAL, INCIDENTAL, OR PUNITIVE DAMAGES HOWEVER CAUSED AND REGARDLESS OF THE THEORY OF LIABILITY OR WHETHER ARISING OUT OF THE USE OF OR INABILITY TO USE SOFTWARE OR OTHERWISE AND EVEN IF CISCO OR ANY APPROVED SOURCE OR THEIR SUPPLIERS OR LICENSORS HAVE BEEN ADVISED OF THE POSSIBILITY OF SUCH DAMAGES.

IF YOU ACQUIRED THE SOFTWARE IN EUROPE, THE MIDDLE EAST, AFRICA, ASIA OR OCEANIA, IN NO EVENT WILL CISCO, ITS AFFILIATES, OFFICERS, DIRECTORS, EMPLOYEES, AGENTS, SUPPLIERS AND LICENSORS, BE LIABLE FOR ANY LOST REVENUE, LOST PROFIT, OR LOST OR DAMAGED DATA, BUSINESS INTERRUPTION, LOSS OF CAPITAL, OR FOR SPECIAL, INDIRECT, CONSEQUENTIAL, INCIDENTAL, OR PUNITIVE DAMAGES, HOWSOEVER ARISING, INCLUDING, WITHOUT LIMITATION, IN CONTRACT, TORT (INCLUDING NEGLIGENCE) OR WHETHER ARISING OUT OF THE USE OF OR INABILITY TO USE THE SOFTWARE, EVEN IF, IN EACH CASE, CISCO, ITS AFFILIATES, OFFICERS, DIRECTORS, EMPLOYEES, AGENTS, SUPPLIERS AND LICENSORS, HAVE BEEN ADVISED OF THE POSSIBILITY OF SUCH DAMAGES. BECAUSE SOME STATES OR JURISDICTIONS DO NOT ALLOW LIMITATION OR EXCLUSION OF CONSEQUENTIAL OR INCIDENTAL DAMAGES, THE ABOVE LIMITATION MAY NOT FULLY APPLY TO YOU. THE FOREGOING EXCLUSION SHALL NOT APPLY TO ANY LIABILITY ARISING OUT OF OR IN CONNECTION WITH: (I) DEATH OR PERSONAL INJURY, (II) FRAUDULENT MISREPRESENTATION, OR (III) CISCO'S LIABILITY IN CONNECTION WITH ANY TERMS THAT CANNOT BE EXCLUDED UNDER APPLICABLE LAW.

Customer acknowledges and agrees that Cisco has set its prices and entered into the Agreement in reliance upon the disclaimers of warranty and the limitations of liability set forth herein, that the same reflect an allocation of risk between the parties (including the risk that a contract remedy may fail of its essential purpose and cause consequential loss), and that the same form an essential basis of the bargain between the parties.

***Controlling Law, Jurisdiction.*** If you acquired, by reference to the address on the purchase order accepted by the Approved Source, the Software in the United States, Latin America, or the Caribbean, the Agreement and warranties ("Warranties") are controlled by and construed under the laws of the State of California, United States of America, notwithstanding any conflicts of law provisions; and the state and federal courts of California shall have exclusive jurisdiction over any claim arising under the Agreement or Warranties. If you acquired the Software in Canada, unless expressly prohibited by local

law, the Agreement and Warranties are controlled by and construed under the laws of the Province of Ontario, Canada, notwithstanding any conflicts of law provisions; and the courts of the Province of Ontario shall have exclusive jurisdiction over any claim arising under the Agreement or Warranties. If you acquired the Software in Europe, the Middle East, Africa, Asia or Oceania (excluding Australia), unless expressly prohibited by local law, the Agreement and Warranties are controlled by and construed under the laws of England, notwithstanding any conflicts of law provisions; and the English courts shall have exclusive jurisdiction over any claim arising under the Agreement or Warranties. In addition, if the Agreement is controlled by the laws of England, no person who is not a party to the Agreement shall be entitled to enforce or take the benefit of any of its terms under the Contracts (Rights of Third Parties) Act 1999. If you acquired the Software in Japan, unless expressly prohibited by local law, the Agreement and Warranties are controlled by and construed under the laws of Japan, notwithstanding any conflicts of law provisions; and the Tokyo District Court of Japan shall have exclusive jurisdiction over any claim arising under the Agreement or Warranties. If you acquired the Software in Australia, unless expressly prohibited by local law, the Agreement and Warranties are controlled by and construed under the laws of the State of New South Wales, Australia, notwithstanding any conflicts of law provisions; and the State and federal courts of New South Wales shall have exclusive jurisdiction over any claim arising under the Agreement or Warranties. If you acquired the Software in any other country, unless expressly prohibited by local law, the Agreement and Warranties are controlled by and construed under the laws of the State of California, United States of America, notwithstanding any conflicts of law provisions; and the state and federal courts of California shall have exclusive jurisdiction over any claim arising under the Agreement or Warranties.

For all countries referred to above, the parties specifically disclaim the application of the UN Convention on Contracts for the International Sale of Goods. Notwithstanding the foregoing, either party may seek interim injunctive relief in any court of appropriate jurisdiction with respect to any alleged breach of such party's intellectual property or proprietary rights. If any portion hereof is found to be void or unenforceable, the remaining provisions of the Agreement and Warranties shall remain in full force and effect. Except as expressly provided herein, the Agreement constitutes the entire agreement between the parties with respect to the license of the Software and Documentation and supersedes any conflicting or additional terms contained in any Purchase Order or elsewhere, all of which terms are excluded. The Agreement has been written in the English language, and the parties agree that the English version will govern.

Product warranty terms and other information applicable to Cisco products are available at the following URL:

<http://www.cisco.com/go/warranty>

## Supplemental End User License Agreement for Cisco Systems Content Security Software

### IMPORTANT: READ CAREFULLY

This Supplemental End User License Agreement ("SEULA") contains additional terms and conditions for the Software product licensed under the End User License Agreement ("EULA") between You ("You" as used herein means You and the business entity you represent or "Company") and Cisco (collectively, the "Agreement"). Capitalized terms used in this SEULA but not defined will have the meanings assigned to them in the EULA. To the extent that there is a conflict between the terms and conditions of the EULA and this SEULA, the terms and conditions of this SEULA will take precedence.

In addition to the limitations set forth in the EULA on your access and use of the Software, you agree to comply at all times with the terms and conditions provided in this SEULA.

DOWNLOADING, INSTALLING, OR USING THE SOFTWARE CONSTITUTES ACCEPTANCE OF THE AGREEMENT, AND YOU ARE BINDING YOURSELF AND THE BUSINESS ENTITY THAT YOU REPRESENT TO THE AGREEMENT. IF YOU DO NOT AGREE TO ALL OF THE TERMS OF THE AGREEMENT, THEN CISCO IS UNWILLING TO LICENSE THE SOFTWARE TO YOU AND (A) YOU MAY NOT DOWNLOAD, INSTALL OR USE THE SOFTWARE, AND (B) YOU MAY RETURN THE SOFTWARE (INCLUDING ANY UNOPENED CD PACKAGE AND ANY WRITTEN MATERIALS) FOR A FULL REFUND, OR, IF THE SOFTWARE AND WRITTEN MATERIALS ARE SUPPLIED AS PART OF ANOTHER PRODUCT, YOU MAY RETURN THE ENTIRE PRODUCT FOR A FULL REFUND. YOUR RIGHT TO RETURN AND REFUND EXPIRES 30 DAYS AFTER PURCHASE FROM CISCO OR AN AUTHORIZED CISCO RESELLER, AND APPLIES ONLY IF YOU ARE THE ORIGINAL END USER PURCHASER.

For purposes of this SEULA, the Product name and the Product description You have ordered is any of the following Cisco Systems Email Security Appliance ("ESA"), Cisco Systems Web Security Appliance ("WSA") and Cisco Systems Security Management Application ("SMA") (collectively, "Content Security") and their Virtual Appliance equivalent ("Software"):

- Cisco AsyncOS for Email
- Cisco AsyncOS for Web
- Cisco AsyncOS for Management
- Cisco Email Anti-Spam, Sophos Anti-Virus
- Cisco Email Outbreak Filters
- Cloudmark Anti-Spam
- Cisco Image Analyzer
- McAfee Anti-Virus
- Cisco Intelligent Multi-Scan
- Cisco RSA Data Loss Prevention
- Cisco Email Encryption
- Cisco Email Delivery Mode
- Cisco Web Usage Controls
- Cisco Web Reputation
- Sophos Anti-Malware
- Webroot Anti-Malware
- McAfee Anti-Malware
- Cisco Email Reporting
- Cisco Email Message Tracking
- Cisco Email Centralized Quarantine
- Cisco Web Reporting
- Cisco Web Policy and Configuration Management
- Cisco Advanced Web Security Management with Splunk
- Email Encryption for Encryption Appliances
- Email Encryption for System Generated Bulk Email
- Email Encryption and Public Key Encryption for Encryption Appliances



Large Attachment Handling for Encryption Appliances

Secure Mailbox License for Encryption Appliances

### Definitions

For purposes of this SEULA, the following definitions apply:

"Company Service" means the Company's email, Internet, security management services provided to End Users for the purposes of conducting Company's internal business.

"End User" means: (1) for the WSA and SMA, the employee, contractor or other agent authorized by Company to access the Internet and the SMA via the Company Service; and (2) for the ESA, the email boxes of the employees, contractors, or other agent authorized by Company to access or use the email services via the Company Service.

"Ordering Document" means the purchase agreement, evaluation agreement, beta, pre-release agreement or similar agreement between the Company and Cisco or the Company and a Cisco reseller, or the valid terms of any purchase order accepted by Cisco in connection therewith, containing the purchase terms for the Software license granted by this Agreement.

"Personally Identifiable Information" means any information that can be used to identify an individual, including, but not limited to, an individual's name, user name, email address and any other personally identifiable information.

"Server" means a single physical computer or devices on a network that manages or provides network resources for multiple users.

"Services" means Cisco Software Subscription Services.

"Service Description" means the description of the Software Subscription Support Services at [http://www.cisco.com/web/about/doing\\_business/legal/service\\_descriptions/index.html](http://www.cisco.com/web/about/doing_business/legal/service_descriptions/index.html)

"Telemetry Data" means samples of Company's email and web traffic, including data on email message and web request attributes and information on how different types of email messages and web requests were handled by Company's Cisco hardware products. Email message metadata and web requests included in Telemetry Data are anonymized and obfuscated to remove any Personally Identifiable Information.

"Term" means the length of the Software subscription You purchased, as indicated in your Ordering Document.

"Virtual Appliance" means the virtual version of Cisco's email security appliances, web security appliances, and security management appliances.

"Virtual Machine" means a software container that can run its own operating system and execute applications like a Server.

### Additional License Terms and Conditions

#### LICENSE GRANTS AND CONSENT TO TERMS OF DATA COLLECTION

##### License of Software.

By using the Software and the Documentation, Company agrees to be bound by the terms of this Agreement, and so long as Company is in compliance with this Agreement, Cisco hereby grants to Company a nonexclusive, non-sublicensable, non-transferable, worldwide license during the Term to use the Software only on Cisco's hardware products, or in the case of the Virtual Appliances, on a Virtual Machine, solely in connection with the provision of the Company Service to End Users. The number of End Users licensed for the use of the Software is limited to the number of End Users specified in the Ordering Documents. In the event that the number of End Users in connection with the provision of the Company Service exceeds the number of End Users specified in the Ordering Documents, Company shall contact an Approved Source to purchase additional licenses for the Software. The duration and

scope of this license(s) is further defined in the Ordering Document. The Ordering Document supersedes the EULA with respect to the term of the Software license. Except for the license rights granted herein, no right, title or interest in any Software is granted to the Company by Cisco, Cisco's resellers or their respective licensors. Your entitlement to Upgrades to the Software is subject to the Service Description. This Agreement and the Services are co-terminus.

**Consent and License to Use Data.**

Subject to the Cisco Privacy Statement at <http://www.cisco.com/web/siteassets/legal/privacy.html>, Company hereby consents and grants to Cisco a license to collect and use Telemetry Data from the Company. Cisco does not collect or use Personally Identifiable Information in the Telemetry Data. Cisco may share aggregated and anonymous Telemetry Data with third parties to assist us in improving your user experience and the Software and other Cisco security products and services. Company may terminate Cisco's right to collect Telemetry Data at any time by disabling SenderBase Network Participation in the Software. Instructions to enable or disable SenderBase Network Participation are available in the Software configuration guide.

**Description of Other Rights and Obligations**

Please refer to the Cisco Systems, Inc. End User License Agreement, Privacy Statement and Service Description of Software Subscription Support Services.

# INDEX

## A

### access log file

see also *W3C access logs*

ACL decision tags [24-17](#)

anti-malware information [24-21](#)

anti-malware request example entry [24-25](#)

anti-malware response example entry [24-25](#)

custom formatting [24-28](#)

no category (nc) [24-22](#)

no score (ns) [24-22](#)

overview [24-14](#)

result codes [24-17](#)

SOCKS [6-4](#)

URL category abbreviations [17-25](#)

Web Reputation Filters example entry [24-25](#)

web reputation information [24-21](#)

### access logs

custom fields [24-37](#)

header format specifier [24-28](#)

SOCKS [6-4](#)

variables [24-28](#)

### Access Policies [17-5](#)

and URL category changes [17-5](#)

anti-malware [9-12](#)

application filtering [9-10](#)

configuring Web Reputation [19-13](#)

creating [9-5](#)

flow diagram [9-9](#)

guest users [8-11](#)

membership [9-4](#)

Monitor action [9-3](#)

objects [9-11](#)

overview [9-1](#)

protocol of request [9-6](#)

protocols and user agents [9-9](#)

proxy port of request [6-3, 9-6](#)

redirecting traffic [17-19](#)

subnet of request [6-3, 9-7](#)

time of request [6-3, 9-7](#)

URL category of request [9-7](#)

URL filters [9-10](#)

user agent of request [9-7](#)

user location of request [9-7](#)

Web Reputation [9-12](#)

### Access Policy groups

see also *policy groups*

### ACL decision tags

access log file [24-17](#)

### Active Directory

changing passwords [20-26](#)

joining the domain [20-34](#)

multiple domains [20-31](#)

transparent user identification [8-13](#)

### Active Directory agent [8-12](#)

### AD agent

See Active Directory agent

### adding

log subscriptions [24-11](#)

WCCP service [25-14](#)

### addresses

ambiguous address [21-1](#)

known allowed address [21-1](#)

known malware address [21-1](#)

unlisted address [21-1](#)

### adminaccessconfig command

overview [26-14](#)

### administering the appliance

connecting to the management interface [2-2](#)

System Setup Wizard [2-2](#)

### administrator access

configuring for IP addresses [26-15](#)

configuring SSL ciphers [26-15](#)

### adult content

filtering [17-17](#)

logging usage [17-18](#)

- advancedproxyconfig command
  - overview [5-20](#)
  - web proxy usage agreement [5-13](#)
- alert listing [26-21](#)
- alert recipient [26-16](#)
- alerts
  - alert classifications [26-17](#)
  - recipients [26-16](#)
  - settings [26-16](#)
  - severities [26-17](#)
- alert settings [26-16](#)
- All Identities
  - overview [7-8](#)
- allow
  - file types [7-2](#)
- allowing traffic
  - L4 Traffic Monitor [21-2](#)
- ambiguous address
  - defined [21-1](#)
- AMW
  - see *anti-malware*
- anonymizing
  - usernames in reports [22-1](#)
- anti-malware
  - access log file [19-17](#)
  - access log information [24-21](#)
  - configuring [19-9](#)
  - database [19-16](#)
  - outbound scanning [12-1](#)
  - overview [19-4](#)
  - rules for L4 Traffic Monitor [21-3](#)
  - scanning verdicts [24-38](#)
- Anti-Malware report [23-15](#)
- anti-malware rules
  - L4 Traffic Monitor [21-3](#)
- anti-malware scanning
  - bypassing [5-11](#)
  - outbound [12-1](#)
- AnyConnect Secure Mobility
  - see *Secure Mobility*
  - AnyConnect Secure Mobility Daemon log
    - Secure Mobility [14-4](#)
- appliance hostname
  - DNS support [4-4](#)
- application behaviors
  - defined [18-3](#)
- application bypass settings
  - configuring [5-13](#)
- application control
  - application behaviors [18-3](#)
  - applications [18-3](#)
  - application types [18-3](#)
  - bandwidth [18-7](#)
  - bypassing application scanning [5-13](#)
  - configuring [18-3, 18-7](#)
  - instant messaging traffic [18-10](#)
  - logging [18-11](#)
  - overview [18-1](#)
  - report [23-13](#)
  - reporting [18-11](#)
  - rules and guidelines [18-6](#)
- applications
  - blocking [18-7](#)
  - configuring bandwidth limits [18-10](#)
  - defined [18-3](#)
- application scanning
  - bypassing [5-13](#)
- application types
  - configuring bandwidth limits [18-9](#)
  - defined [18-3](#)
  - overriding bandwidth limits [18-9](#)
- Application Visibility and Control
  - see *application control*
- Application Visibility and Control engine
  - see *AVC engine*
- Application Visibility report
  - overview [23-13](#)
- archiving reports [22-10](#)

- assignment method
    - WCCP service [25-12](#)
  - AsyncOS reversion [26-40](#)
  - AsyncOS upgrades
    - overview [26-33](#)
  - authentication
    - behavior with multiple realms [20-12](#)
    - bypassing [20-25](#)
    - compared to authorization [7-7](#)
    - configuring global settings [20-15](#)
    - configuring LDAP [20-26](#)
    - configuring NTLM [20-31](#)
    - defined [7-7](#)
    - entering the domain [20-3](#)
    - exempting user agents [7-12](#)
    - failure [20-3](#)
    - global Identity policy [8-5](#)
    - guest access [8-10](#)
    - HTTPS requests [8-6](#)
    - Identity groups [8-5](#)
    - LDAP [20-26](#)
    - MSN Messenger [8-20](#)
    - native FTP [5-8](#)
    - NTLM [20-31](#)
    - overview [20-1](#)
    - realms [20-10](#)
    - re-authenticating users [20-22](#)
    - SaaS applications [15-4](#)
    - secure LDAP [20-26](#)
    - sending credentials securely [20-21](#)
    - sequences [20-11](#)
    - special characters [20-36](#)
    - supported characters for Basic [20-31](#)
    - surrogates [20-23](#)
    - surrogates supported [20-24](#)
    - testing settings [20-13](#)
    - upstream proxies [20-2](#)
  - authentication credentials
    - defined [20-4](#)
    - invalid [20-3](#)
    - SaaS Access Control [15-2](#)
    - sending securely [20-21](#)
  - authentication realms
    - behavior with multiple realms [20-12](#)
    - creating [20-10](#)
    - deleting [20-11](#)
    - overview [20-10](#)
    - testing settings [20-13](#)
  - authentication scheme
    - Identity group [8-7](#)
  - authentication sequences
    - behavior with multiple realms [20-12](#)
    - creating [20-11](#)
    - deleting [20-12](#)
    - overview [20-11](#)
  - authentication server
    - unavailable [20-3](#)
  - authentication surrogates
    - supported [20-24](#)
  - authorization
    - defined [7-7](#)
    - failing [20-22](#)
  - AutoSupport feature [26-18](#)
  - available upgrades [26-34](#)
  - AVC engine
    - enabling [18-2](#)
    - updates [18-2](#)
- 
- B**
- bandwidth
    - configuring overall limits [18-8](#)
    - configuring user limits [18-8](#)
    - limiting [18-7](#)
  - bandwidth limits
    - configuring for applications [18-10](#)
    - configuring for application types [18-9](#)
    - overall [18-8](#)

overriding for application types [18-9](#)

overview [18-7](#)

per user [18-8](#)

#### Basic authentication

securely sending credentials [20-21](#)

#### blacklist address

see *known malware address*

#### block

file types [7-2](#)

#### blocking

adult content [17-17](#)

all traffic by default [4-12](#)

applications [9-12, 18-7](#)

file types [9-14](#)

HTTPS traffic [11-11](#)

instant messenger [9-12](#)

objects [9-11, 9-14, 13-12](#)

peer-to-peer [9-14](#)

ports [9-9, 21-3](#)

protocols [9-9](#)

traffic [21-3](#)

upload requests [13-2, 17-21](#)

upload requests due to AVC engine [18-2](#)

upload requests due to malware [12-1](#)

URL categories [9-10, 13-11](#)

user agents [9-9](#)

user experience [12-1, 13-2, 17-21, 18-2](#)

#### blocking traffic

by default in System Setup Wizard [4-12](#)

L4 Traffic Monitor [21-2](#)

#### browsers

see *web browsers*

#### browse view

application control [18-3](#)

#### bypassing

application scanning [5-13](#)

authentication [20-25](#)

decryption [11-22](#)

scanning and filtering [5-11](#)

upload requests from scanning [13-2](#)

## C

### CA

see *certificate authorities*

caching [19-17](#)

capturing network packets

overview [26-4](#)

case-sensitivity

in CLI [27-3](#)

categories

adult [17-25](#)

advertisements [17-25](#)

alcohol [17-26](#)

arts [17-26](#)

astrology [17-26](#)

auctions [17-26](#)

business and industry [17-26](#)

chat and instant messaging [17-26](#)

cheating and plagiarism [17-26](#)

child abuse content [17-26](#)

computers and internet [17-27](#)

computer security [17-26](#)

dating [17-27](#)

digital postcards [17-27](#)

dining and drinking [17-27](#)

dynamic and residential [17-27](#)

education [17-27](#)

entertainment [17-27](#)

extreme [17-27](#)

fashion [17-27](#)

file transfer services [17-27](#)

filter avoidance [17-27](#)

finance [17-28](#)

freeware and shareware [17-28](#)

gambling [17-28](#)

games [17-28](#)

government and law [17-28](#)

- hacking [17-28](#)
- hate speech [17-28](#)
- health and nutrition [17-29](#)
- humor [17-29](#)
- illegal activities [17-29](#)
- illegal downloads [17-29](#)
- illegal drugs [17-29](#)
- infrastructure and content delivery networks [17-29](#)
- internet telephony [17-29](#)
- job search [17-29](#)
- lingerie and swimsuits [17-29](#)
- lotteries [17-29](#)
- mobile phones [17-29](#)
- nature [17-30](#)
- news [17-30](#)
- non-governmental organizations [17-30](#)
- non-sexual nudity [17-30](#)
- online communities [17-30](#)
- online storage and backup [17-30](#)
- online trading [17-30](#)
- organizational email [17-30](#)
- parked domains [17-30](#)
- peer file transfer [17-30](#)
- personal sites [17-31](#)
- photo searches and images [17-31](#)
- politics [17-31](#)
- pornography [17-31](#)
- professional networking [17-31](#)
- real estate [17-31](#)
- reference [17-31](#)
- religion [17-31](#)
- SaaS and B2B [17-31](#)
- safe for kids [17-31](#)
- science and technology [17-31](#)
- search engines and portals [17-31](#)
- sex education [17-31](#)
- shopping [17-31](#)
- social networking [17-32](#)
- social science [17-32](#)
- society and culture [17-32](#)
- software updates [17-32](#)
- sports and recreation [17-32](#)
- streaming audio [17-32](#)
- streaming video [17-32](#)
- tobacco [17-32](#)
- transportation [17-32](#)
- travel [17-32](#)
- unclassified [17-32](#)
- weapons [17-33](#)
- web-based email [17-33](#)
- web hosting [17-33](#)
- web page translation [17-33](#)
- category filtering
  - database [17-3](#)
- certificate authorities
  - validating [A-5](#)
- certificate authority
  - defined [A-2](#)
- certificate files
  - see also *root certificates*
  - converting formats [A-9](#)
  - supported formats [11-3](#)
  - uploading [11-8, 15-6](#)
- certificates
  - CSR for HTTPS Proxy [11-9](#)
  - CSR for Identity Provider for SaaS [15-7](#)
  - CSR for web interface [26-30](#)
  - FIPS [26-27](#)
  - generating and signing your own [26-31](#)
  - installing for credential encryption [20-21](#)
  - installing on appliance [26-31](#)
  - invalid [11-10, 11-11](#)
  - overview [A-5](#)
  - root [A-8](#)
  - SaaS Access Control [15-2](#)
  - validating [11-6](#)
  - validating certificate authorities [A-5](#)
- Certificate Signing Request (CSR)

- for HTTPS Proxy [11-9](#)
  - for Identity Provider for SaaS [15-7](#)
  - for web interface [26-30](#)
- Change Password link [26-11](#)
- changing passwords [26-11](#)
- cipher
  - defined [A-2](#)
- ciphertext
  - defined [A-2](#)
- Cisco Active Directory Agent
  - See Cisco Context Directory Agent
- Cisco Active Directory Agent [8-13, 8-14](#)
- Cisco ASA integration
  - configuring [14-3](#)
  - overview [14-2](#)
- Cisco Context Directory Agent [8-12](#)
- Cisco IronPort Data Security Filters
  - overview [13-1](#)
- Cisco IronPort Data Security Policies
  - and URL category changes [17-5](#)
  - see *Data Security Policies*
  - user location of request [13-9](#)
- Cisco IronPort Web Usage Controls
  - overview [17-1](#)
- cleartext
  - defined [A-2](#)
- CLI
  - case-sensitivity in [27-3](#)
  - clearing changes [2-10](#)
  - committing changes [2-10](#)
  - configuring host keys [24-10](#)
  - configuring languages [26-14](#)
  - overview [2-3, 27-1](#)
  - rolling over log files [24-8](#)
  - SSH [27-1](#)
  - supported languages [2-6](#)
  - viewing most recent log files [24-10](#)
  - warning message [26-14](#)
  - welcome message [26-14](#)
- Client Malware Risk [23-19](#)
- Client Malware Risk report [23-19](#)
- Client Malware Risk report page [23-19](#)
- command line interface
  - see *CLI*
- Commit Changes button
  - overview [2-9](#)
- commit command [2-10, 27-5](#)
- committing changes
  - commit command [2-10](#)
  - overview [2-9](#)
  - Web Proxy restart effects [2-10](#)
- community string
  - SNMP [22-11](#)
- compressing
  - log files [24-10](#)
- computer account
  - joining an Active Directory domain [20-34](#)
- configuration file [26-2](#)
- configuring [25-5](#)
  - administrator settings [26-14](#)
  - application control settings [18-3](#)
  - custom text at login [26-14](#)
  - data interfaces [25-2](#)
  - FTP proxy, advanced options [5-20](#)
  - host keys [24-10](#)
  - HTTPS Proxy [11-13](#)
  - Identities [8-22](#)
  - proxy cache options [5-21](#)
  - return addresses [26-15](#)
  - URL filters [17-9](#)
  - WCCP router [3-6](#)
  - web proxy, advanced options [5-20](#)
  - Web Reputation Filters [19-13](#)
- configuring the appliance
  - anti-malware [19-9](#)
  - browser requirements [2-6](#)
  - clearing changes [2-9](#)
  - committing changes [2-9, 26-2](#)



- enabling features [26-6](#)
- L4 Traffic Monitor [21-2](#)
- log files [24-7](#)
- network interfaces [25-2](#)
- P2 port [25-2](#)
- reporting [22-1](#)
- scheduling reports [22-8](#)
- submitting changes [26-2](#)
- upstream proxies [3-10](#)
- Web Proxy settings [5-3](#)
- connecting
  - L4 Traffic Monitor [3-12](#)
  - web proxy in explicit forward mode [3-5](#)
  - web proxy in transparent mode [3-6](#)
- connecting the appliance
  - Layer 4 switch [3-3, 4-2](#)
  - P1 and P2 ports [3-3, 4-2](#)
  - serial line [2-3](#)
  - WCCP router [3-3, 4-2](#)
- content filtering
  - Cisco IronPort Data Security Policies [13-12](#)
- controlling applications
  - overview [18-1](#)
- controlling bandwidth
  - overall limits [18-8](#)
  - overview [18-7](#)
  - user limits [18-8](#)
- control settings
  - Decryption Policies [11-19](#)
- creating
  - Access Policies [9-5](#)
  - authentication realms [20-10](#)
  - authentication sequences [20-11](#)
  - Cisco IronPort Data Security Policies [13-6](#)
  - Decryption Policies [11-16](#)
  - External DLP Policies [13-6](#)
  - Identities [8-18](#)
  - log subscriptions [24-11](#)
  - Outbound Malware Scanning Policies [12-4](#)
  - Routing Policies [10-5](#)
  - time ranges [7-9](#)
  - user agent based policies [7-11](#)
- credential encryption
  - certificate and key [20-21](#)
  - FTP requests [20-22](#)
  - HTTPS requests [20-22](#)
  - overview [20-21](#)
- cryptography
  - certificate authority [A-2](#)
  - cipher [A-2](#)
  - ciphertext [A-2](#)
  - cleartext [A-2](#)
  - digital certificate [A-2](#)
  - digital signature [A-2](#)
  - key [A-2](#)
  - overview [A-2](#)
  - plaintext [A-2](#)
  - private key [A-3](#)
  - public key [A-3](#)
  - public key infrastructure [A-3](#)
  - root certificate [A-3](#)
  - self-signed certificate [A-3](#)
  - symmetric key [A-3](#)
- CSS
  - in end-user notification pages [16-17](#)
- custom
  - headers [5-6, 5-22, 5-30, 24-28](#)
- custom fields
  - access and W3C logs [24-37](#)
- customizing
  - log files [24-28](#)
- custom text [26-14](#)
  - at login [26-14](#)
- custom URL categories
  - overview [17-15](#)
  - redirecting traffic [17-19](#)
- custom welcome message
  - configuring for CLI [26-14](#)

**D**

## data interfaces

- configuring [25-2](#)
- overview [3-3](#)

## data loss prevention

- see *Data Security Policies*
- see *External DLP Policies*
- see *Outbound Malware Scanning Policies*

Data Loss Prevention Policies, External [17-5](#)

## datasecurityconfig

- CLI command [13-2](#)

## Data Security logs

- overview [13-17](#)

## Data Security Policies

- configuring [13-9](#)
- content [13-12](#)
- creating [13-6](#)
- flow diagram [13-11](#)
- logging [13-17](#)
- membership [13-4](#)
- minimum request size [13-2](#)
- Monitor action [13-4](#)
- overview [13-1](#)
- protocol of request [13-8](#)
- proxy port of request [13-8](#)
- subnet of request [13-8](#)
- upload request definition [13-3](#)
- URL category of request [13-8](#)
- URL filters [13-11](#)
- user agent of request [13-9](#)
- Web Reputation [13-2](#)

Data Security Policies, Cisco IronPort [17-5](#)

## Data Security Policy groups

- see *policy groups*

## debugging

- policy groups [7-12](#)

## decrypting

- HTTPS traffic [11-2](#)

- overview [A-6](#)

## decrypting HTTPS traffic

- configuring Decryption Policies [11-1](#)
- overview [A-6](#)

## decryption

- bypassing [11-22](#)

Decryption Policies [17-5](#)

- and URL category changes [17-5](#)
- blocking [11-11](#)
- bypassing decryption [11-22](#)
- controlling traffic [11-19](#)
- control settings [11-19](#)
- creating [11-16](#)
- cryptography [A-2](#)
- decrypting traffic [11-1, A-6](#)
- dropping traffic [11-1](#)
- enabling [11-13](#)
- flow diagram [11-15, 11-21](#)
- guest users [8-11](#)
- logging [11-23](#)
- membership [11-14](#)
- Monitor action [11-2](#)
- overview [11-2](#)
- passing through traffic [11-1](#)
- proxy port of request [11-18](#)
- root certificates [A-8](#)
- subnet of request [11-18](#)
- time of request [11-18](#)
- URL category of request [11-18](#)
- user agent of request [11-19](#)
- user location of request [11-19](#)

## Decryption Policy groups

- see also *policy groups*

default gateway [25-5](#)

## default route

- configuring [25-5](#)

## defining

- user preferences [26-14](#)

## deleting

- a URL from the web proxy cache [5-3](#)
  - authentication realms [20-11](#)
  - authentication sequences [20-12](#)
  - log subscriptions [24-14](#)
  - WCCP service [25-15](#)
  - DEM format
    - converting [A-9](#)
  - deploying the appliance
    - L4 Traffic Monitor [3-2, 3-11](#)
    - multiple appliances and WCCP routers [3-10](#)
    - overview [3-1](#)
    - see also *deployment*
    - web proxy [3-1](#)
  - deployment
    - connecting to a WCCP router [3-6](#)
    - example scenario [3-4](#)
    - existing proxies [3-10](#)
    - L4 Traffic Monitor [3-11](#)
    - overview [3-1](#)
    - PAC files [3-5](#)
    - preparing for [3-1](#)
    - web proxy in explicit forward mode [3-4](#)
    - web proxy in transparent mode [3-5](#)
  - DHCP
    - WPAD [5-16](#)
  - digital certificate
    - defined [A-2](#)
    - see also *certificates*
  - digital cryptography
    - see *cryptography*
  - digital signature
    - defined [A-2](#)
  - DLP servers
    - defining [13-13](#)
    - failover [13-15](#)
  - DNS
    - authoritative name servers [25-17](#)
    - configuring [25-17](#)
    - installing the appliance [4-4](#)
    - split [25-17](#)
    - WPAD [5-16](#)
  - DNS cache
    - flushing [25-18](#)
  - domain
    - entering for authentication [20-3](#)
  - dropping traffic
    - Decryption Policies [11-1](#)
  - duplex
    - deploying the L4 Traffic Monitor [3-12](#)
    - network tap [4-2](#)
  - DVS engine
    - how it works [19-5](#)
    - overview [19-4](#)
    - working with multiple malware verdicts [19-5](#)
  - Dynamic Content Analysis engine
    - enabling [17-4](#)
    - overview [17-2](#)
  - dynamic service
    - WCCP services [25-12](#)
  - Dynamic Vectoring and Streaming engine
    - see *DVS engine*
- 
- ## E
- editing
    - WCCP service [25-14](#)
  - editing the appliance
    - concurrent editing [2-6](#)
  - enabling
    - HTTPS Proxy [11-13](#)
    - P2 port [25-2](#)
    - Secure Mobility [14-2](#)
  - end-user acknowledgement page
    - configuring [16-14](#)
    - FTP requests [16-14](#)
    - HTTPS requests [16-14](#)
    - overview [16-11](#)
  - end-user notification pages

- customizing [16-5](#)
  - formatting text [16-17](#)
  - HTML tags [16-17](#)
  - native FTP [16-16](#)
  - on-box notification pages [16-3](#)
  - overview [16-1](#)
  - tokens [16-5](#)
  - user defined notification pages [16-9](#)
  - variables [16-5](#)
  - end-user URL category page
    - configuring [16-15](#)
    - warning users [17-20](#)
  - etherconfig command
    - VLAN [25-7](#)
  - evaluating Access Policy membership
    - matching client requests [9-4](#)
  - evaluating Data Security Policy membership
    - matching client requests [13-5](#)
  - evaluating Decryption Policy membership
    - matching client requests [11-15](#)
  - evaluating External DLP Policy membership
    - matching client requests [13-5](#)
  - evaluating Identity group membership
    - authentication [8-5](#)
    - authentication scheme [8-7](#)
    - examples [8-23](#)
    - matching client requests [8-8](#)
    - overview [8-4](#)
  - evaluating Outbound Malware Scanning membership
    - matching client requests [12-3](#)
  - evaluating policy group membership
    - overview [7-7](#)
  - evaluating Routing Policy membership
    - matching client requests [10-4](#)
  - exempting
    - user agents from authentication [7-12](#)
  - expired keys
    - overview [26-8](#)
  - exporting
    - reports [22-6](#)
  - External Data Loss Prevention
    - and URL Category changes [17-5](#)
  - externaldlpconfig
    - CLI command [13-2](#)
  - External DLP Policies
    - configuring [13-16](#)
    - creating [13-6](#)
    - defining external DLP servers [13-13](#)
    - ICAP [13-1](#)
    - load balancing [13-15](#)
    - logging [13-17](#)
    - membership [13-4](#)
    - minimum request size [13-2](#)
    - overview [13-1](#)
    - protocol of request [13-8](#)
    - proxy port of request [13-8](#)
    - subnet of request [13-8](#)
    - URL category of request [13-8](#)
    - user agent of request [13-9](#)
    - user location of request [13-9](#)
  - External DLP Policy groups
    - see *policy groups*
  - external DLP servers
    - see *DLP servers*
- 
- ## F
- failed authentication
    - allowing guest access [8-10](#)
    - overview [20-3](#)
  - failing authorization [20-22](#)
  - failover
    - DLP servers [13-15](#)
    - Routing Policies [10-2](#)
  - feature keys
    - adding manually [26-8](#)
    - expired keys [26-8](#)
    - overview [26-6](#)

- settings [26-7](#)
- Federal Information Processing Standards [26-26](#)
- Federal Information Processing Standards (FIPS) [26-26](#)
- filtering
  - adult content [17-17](#)
  - anti-malware [9-12](#)
  - category [9-10, 13-11](#)
  - data in Cisco IronPort Data Security Policies [13-12](#)
  - objects in Access Policies [9-11](#)
  - protocols [9-9](#)
  - user agents [9-9](#)
  - Web Reputation [9-12, 13-12](#)
- FIPS
  - certificate requirements [26-27](#)
  - compliance [26-26](#)
  - mode [26-27](#)
- Firefox
  - PAC files [5-20](#)
- formatting
  - access log [24-28](#)
  - end-user acknowledge pages [16-17](#)
  - end-user notification pages [16-17](#)
- forwarding method
  - GRE [25-13](#)
  - L2 [25-13](#)
  - WCCP service [25-13](#)
- FTP
  - see also *native FTP*
  - active mode [5-7, 5-22](#)
  - configuring notification messages [16-16](#)
  - credential encryption [20-22](#)
  - end-user acknowledgement page [16-14](#)
  - FTP over HTTP [5-7](#)
  - passive mode [5-7](#)
- FTP Poll [24-13](#)
- FTP Proxy
  - overview [5-7](#)
- FTP proxy
  - advanced configuration [5-20](#)

- FTP Push [24-13](#)

---

## G

- generating
  - root certificates [11-8](#)
  - root certificates for HTTPS [A-8](#)
- global Identity policy
  - authentication [8-5](#)
- global policy group
  - overview [7-5](#)
- GRE
  - forwarding method [25-13](#)
- greylist address
  - see *ambiguous address*
- guest access
  - overview [8-10](#)
- GUI
  - configuring language [26-14](#)
  - supported languages [2-6](#)

---

## H

- hash assignment
  - WCCP assignment method [25-13](#)
- headers
  - custom [5-6, 5-22, 5-30, 24-28](#)
- heuristic analysis
  - McAfee scanning engine [19-7](#)
- hostkeyconfig command [24-10](#)
- host keys
  - configuring [24-10](#)
- hostname
  - appliance [4-4](#)
  - changing [25-1](#)
- HTTP/HTTPS headers
  - logging [24-37](#)
- HTTPS

- authentication [8-6](#)
  - bypassing decryption [11-22](#)
  - certificate authority definition [A-2](#)
  - cipher definition [A-2](#)
  - ciphertext definition [A-2](#)
  - cleartext definition [A-2](#)
  - credential encryption [20-22](#)
  - digital certificate definition [A-2](#)
  - digital signature definition [A-2](#)
  - end-user acknowledgement page [16-14](#)
  - key definition [A-2](#)
  - logging [11-23](#)
  - overview [A-3](#)
  - plaintext definition [A-2](#)
  - private key cryptography definition [A-3](#)
  - public key cryptography definition [A-3](#)
  - public key infrastructure definition [A-3](#)
  - root certificate definition [A-3](#)
  - self-signed certificate definition [A-3](#)
  - symmetric key cryptography definition [A-3](#)
  - transparently redirected transactions [3-6, A-2](#)
- HTTPS Proxy
- configuring [11-13](#)
  - decrypting traffic [A-6](#)
  - transparently redirected transactions [3-6, A-2](#)
- HTTPS requests
- authentication [8-6](#)
- 
- ICAP
- External DLP Policies [13-1](#)
- identifying users transparently
- see *transparent user identification*
- Identities [17-5](#)
- about [8-1](#)
  - and URL category changes [17-5](#)
  - authentication [8-5](#)
  - configuring in policy groups [8-22](#)
  - creating [8-18](#)
  - evaluating membership [8-4](#)
  - guest privileges [8-10](#)
  - local users [14-2](#)
  - multiple [8-22](#)
  - remote users [14-2](#)
- Identity groups
- see also *policy groups*
  - proxy port of request [8-4](#)
  - URL category of request [8-4](#)
  - user agent of request [8-4](#)
- identity provider
- configuring [15-5](#)
  - defined [15-2](#)
- identity provider initiated flow
- SaaS Access Control [15-2](#)
- installation
- reverting [26-40](#)
- installing the appliance
- prerequisites [4-1](#)
  - setup worksheet [4-2](#)
- instant messaging traffic
- controlling [18-10](#)
- interfaceconfig command
- VLAN [25-10](#)
- interfaces
- see *network interfaces* [25-2](#)
- Internet Explorer
- re-authentication [20-23](#)
  - WPAD [5-17](#)
- invalid
- signing, leaf certificate [11-11](#)
- invalid certificates
- handling [11-11](#)
- IP based access
- about [26-15](#)
- IPMI
- SNMP [22-11](#)
- IP spoofing

WCCP service [25-13](#)

## J

joining

Active Directory domain [20-34](#)

## K

key

defined [A-2](#)

key files

see also *root certificates*

converting formats [A-9](#)

supported formats [11-3](#)

keys

overview [26-6](#)

known allowed address

defined [21-1](#)

known malware address

defined [21-1](#)

## L

L2

forwarding method [25-13](#)

L4 Traffic Monitor

allowing traffic [21-2](#)

allow list [21-4](#)

ambiguous addresses [21-1](#)

anti-malware rules [21-3](#)

blocking [21-3](#)

blocking traffic [21-2](#)

configuring [21-2](#)

database [21-2](#)

deploying [3-2, 3-11](#)

how it works [21-1](#)

interfaces [3-3](#)

known allowed addresses [21-1](#)

known malware addresses [21-1](#)

L2 switch [3-12](#)

log files [24-39](#)

monitoring [21-3](#)

monitoring traffic [21-2](#)

overview [21-1](#)

report [23-24](#)

span/mirror port [3-12](#)

unlisted addresses [21-1](#)

viewing activity [21-5](#)

L4 Traffic Monitor interfaces

overview [3-3](#)

languages

defining default per user [26-14](#)

supported [2-6](#)

user preferences [26-14](#)

last command [26-12](#)

Layer 4 switch

connecting to the appliance [4-2](#)

defined [3-2](#)

LDAP

overview [20-26](#)

realms [20-10](#)

testing settings [20-14](#)

load balancing

traffic to external DLP servers [13-15](#)

traffic to upstream proxies [10-2](#)

load-balancing method

see *assignment method*

local users

overview [14-2](#)

log fields

W3C access logs [24-27](#)

log files

see also *log subscriptions*

compressed [24-10](#)

configuring host keys for SSH [24-10](#)

configuring the level of information recorded [24-12](#)

- custom [24-28](#)
- extensions in filenames [24-8](#)
- formatting access and W3C logs [24-28](#)
- HTTP/HTTPS headers [24-37](#)
- L4 Traffic Monitor [24-29](#)
- naming convention [24-8](#)
- overview [24-1](#)
- types [24-1](#)
- viewing most recent version [24-10](#)

logging

- HTTP/HTTPS headers [24-37](#)
- HTTPS requests [11-23](#)
- redirected traffic [17-20](#)
- Secure Mobility [14-4](#)
- SMTP transactions [24-3](#)
- SOCKS [6-4](#)
- YouTube headers [24-28](#)

logging in

- web interface [2-5](#)

login [26-14](#)

login message

- configuring for CLI [26-14](#)

logs

- see also *log files*
- FTP Poll [24-13](#)
- FTP Push [24-13](#)
- overview [24-1](#)
- rolling over [24-8](#)
- SCP Push [24-13](#)
- Syslog Push [24-13](#)

log subscriptions

- adding [24-11](#)
- compressing [24-10](#)
- deleting [24-14](#)
- editing [24-11](#)
- overview [24-7](#)
- rolling over [24-8](#)

---

## M

M1 interface

- overview [3-3](#)

M1 port

- connecting to a laptop [4-1](#)

MAIL FROM

- configuring for notifications [26-15](#)

malware

- configuring scanning [19-9](#)
- see also *anti-malware*

malware verdicts

- multiple [19-5](#)

management interface

- overview [3-3](#)

managing the appliance

- connecting to a laptop [4-1](#)
- connecting to the management interface [2-2](#)
- System Setup Wizard [2-2](#)

mask assignment

- WCCP assignment method [25-12](#)

matching client requests

- Access Policies [9-4](#)
- Cisco IronPort Data Security Policies [13-5](#)
- Decryption Policies [11-15](#)
- External DLP Policies [13-5](#)
- Identities [8-8](#)
- Outbound Malware Scanning Policies [12-3](#)
- Routing Policies [10-4](#)

McAfee scanning engine

- categories [19-8](#)
- database [19-16](#)
- heuristic analysis [19-7](#)
- overview [19-7](#)

membership diagram

- Access Policies [9-4](#)
- Cisco IronPort Data Security Policies [13-5](#)
- Decryption Policies [11-15](#)
- External DLP Policies [13-5](#)



- Identities [8-8](#)
- Outbound Malware Scanning Policies [12-3](#)
- Routing Policies [10-4](#)
- Metadata File for Service Provider
  - SaaS applications [15-10](#)
- MIB file
  - SNMP [22-11](#)
- mirror port
  - deploying the L4 Traffic Monitor [3-12](#)
- misclassified URLs
  - reporting [16-5](#)
  - URL submission tool [17-3](#)
- mobile users
  - overview [14-2](#)
- Monitor
  - Access Policies [9-3](#)
  - Cisco IronPort Data Security Policies [13-4](#)
  - Decryption Policies [11-2](#)
- monitoring
  - L4 Traffic Monitor [21-3](#)
  - ports [21-3](#)
  - scheduling reports [22-8](#)
  - summary data [22-1](#)
  - system activity [23-1](#)
  - traffic [21-2](#)
  - users from the CLI [26-11](#)
- MSN Messenger
  - authentication [8-20](#)
- multiple Active Directory domains
  - overview [20-31](#)
- multiple Identities
  - overview [8-22](#)
- musconfig command
  - overview [14-4](#)
- musstatus command
  - overview [14-4](#)

---

## N

- native FTP
  - authentication [5-8](#)
  - configuring notification messages [16-16](#)
  - guidelines [5-7](#)
  - overview [5-7](#)
  - transparently redirected connections [5-9](#)
- navigating
  - web interface [2-4](#)
- negotiating
  - SSL session [A-4](#)
- Netscape
  - PAC files [5-20](#)
- network interfaces [25-2](#)
  - appliance ports [3-2](#)
  - enabling P2 [25-2](#)
  - M1 [3-3](#)
  - P1 and P2 [3-3](#)
  - T1 and T2 [3-3](#)
  - VLANs [25-6](#)
- network tap
  - duplex [3-12, 4-2](#)
  - simplex [3-12, 4-2](#)
- no category (nc) [24-22](#)
- no score (ns) [24-22](#)
- notification pages
  - see *end-user notification pages*
- Novell eDirectory
  - transparent user identification [8-15](#)
- NTLM
  - bypassing [20-25](#)
  - computer account [20-34](#)
  - entering a domain [20-3](#)
  - joining an Active Directory domain [20-34](#)
  - overview [20-31](#)
  - realms [20-10](#)
  - testing settings [20-14](#)
- NTLMSSP

bypassing [20-25](#)  
 in authentication sequences [20-11](#)

---

## O

object filtering

Access Policies [9-11](#)

objects

blocking [9-11, 13-12](#)

OCSP [11-12](#)

on-box notification pages

overview [16-3](#)

on-demand reports [22-9](#)

outbound malware scanning

overview [12-1](#)

Outbound Malware Scanning Policies [17-5](#)

configuring [12-6](#)

creating [12-4](#)

logging [12-8](#)

membership [12-2](#)

overview [12-1](#)

protocol of request [12-5](#)

proxy port of request [12-5](#)

subnet of request [12-5](#)

URL category of request [12-5](#)

user agent of request [12-6](#)

user location of request [12-6](#)

Outbound Malware Scanning Policy groups

see also *policy groups*

Outbound Malware Scan Policy

and URL category changes [17-5](#)

Overview report [23-1](#)

---

## P

P1 and P2 interfaces

overview [3-3](#)

P2 port

configuring [25-2](#)

PAC files

configuring browsers [5-16](#)

deployment [3-5](#)

format [5-15](#)

Netscape and Firefox [5-20](#)

overview [5-14](#)

re-authentication [20-24](#)

storing on the appliance [5-17](#)

WPAD [5-16](#)

packet capture

editing settings [26-5](#)

overview [26-4](#)

starting [26-5](#)

pages in the web interface [2-5](#)

passing through traffic

Decryption Policies [11-1](#)

passwords

Active Directory [20-26](#)

changing [26-11](#)

creating [26-9](#)

special characters [20-36](#)

PDF

reports [22-6](#)

PER format

converting [A-9](#)

pinout

serial connection [2-3](#)

plaintext

defined [A-2](#)

policies

block/allow file types [7-2](#)

policies table

examples [8-23](#)

overview [7-5](#)

policy group member definition

Access Policies [9-4](#)

Cisco IronPort Data Security Policies [13-4](#)

Decryption Policies [11-14](#)

- External DLP Policies [13-4](#)
- Identities [8-4](#)
- Outbound Malware Scanning Policies [12-2](#)
- overview [7-7](#)
- Routing Policies [10-4](#)
- user agent based [7-11](#)
- policy groups
  - about [7-1](#)
  - Access Policies [9-1](#)
  - All Identities [7-8](#)
  - Cisco IronPort Data Security Policies [13-1](#)
  - creating [7-5](#)
  - custom URL categories [17-15](#)
  - Decryption Policies [11-1](#)
  - evaluating group membership [7-7](#)
  - External DLP Policies [13-1](#)
  - global policy group [7-5](#)
  - guidelines [7-8](#)
  - Outbound Malware Scanning Policies [12-1](#)
  - overview [7-4](#)
  - policies table [7-5](#)
  - time based [7-9](#)
  - tracing [7-12](#)
  - types of policies [7-2](#)
  - user agent based [7-10](#)
- policy types
  - overview [7-2](#)
- ports
  - Access Policies [6-3, 9-6](#)
  - blocking [9-9](#)
  - Cisco IronPort Data Security Policies [13-8](#)
  - Decryption Policies [11-18](#)
  - External DLP Policies [13-8](#)
  - Identities [8-4](#)
  - Outbound Malware Scanning Policies [12-5](#)
  - Routing Policies [10-6](#)
  - see also *network interfaces*
- preferences
  - defining for users [26-14](#)

- private key cryptography
  - defined [A-3](#)
- protocol filtering
  - Access Policies [9-9](#)
- protocols
  - Access Policies [9-6](#)
  - blocking [9-9](#)
  - Cisco IronPort Data Security Policies [13-8](#)
  - External DLP Policies [13-8](#)
  - Outbound Malware Scanning Policies [12-5](#)
  - Routing Policies [10-6](#)
- proxy
  - see *web proxy*
- Proxy Buffer Memory [23-37, 23-38](#)
- proxy bypass list
  - about [5-11](#)
  - using with WCCP [5-13](#)
- proxy cache
  - configuring [5-21](#)
- proxy groups
  - creating [10-3](#)
- public key cryptography
  - defined [A-3](#)
- public key infrastructure
  - defined [A-3](#)

---

## R

- realms
  - see *authentication realms*
- re-authentication
  - overview [20-22](#)
  - using with Internet Explorer [20-23](#)
  - using with PAC files [20-24](#)
- redirecting traffic
  - logging and reporting [17-20](#)
  - overview [17-19](#)
- Redirect setting
  - URL categories [17-19](#)

- regular expressions
  - overview [17-23](#)
  - using in URL filters [17-23](#)
- remote upgrades [26-37](#)
- remote users
  - overview [14-2](#)
- reporting
  - redirected traffic [17-20](#)
- reporting misclassified URLs [16-5](#)
- reports
  - anonymizing usernames [22-1](#)
  - Anti-Malware [23-15](#)
  - Application Visibility [23-13](#)
  - archiving [22-10](#)
  - charts [22-4](#)
  - Client Detail [23-21](#)
  - Client Malware Risk [23-19](#)
  - Client Malware Risk Page [23-19](#)
  - custom date ranges [22-2](#)
  - exporting data [22-6](#)
  - graphs [22-4](#)
  - interactive display [22-1](#)
  - L4 Traffic Monitor [23-24](#)
  - making usernames unrecognizable [22-1](#)
  - Malware Category [23-17](#)
  - Malware Threat [23-18](#)
  - on-demand [22-9](#)
  - Overview [23-1](#)
  - printing to PDF [22-6](#)
  - Reports by User Location [23-30](#)
  - return address [26-15](#)
  - scheduling [22-8](#)
  - search option [22-3](#)
  - System Capacity [23-36](#)
  - System Status [23-38](#)
  - time range for scheduled reports [22-8](#)
  - time ranges [22-2](#)
  - uncategorized URLs [23-12](#)
  - URL Categories [23-10](#)
  - Web Reputation Filters [23-22](#)
  - Web Sites [23-8](#)
- Reports by User Location report
  - overview [23-30](#)
- restarting Web Proxy
  - effects [2-10](#)
- result codes [24-17](#)
- return addresses
  - configuring [26-15](#)
- reversion
  - versions available [26-41](#)
- revert
  - installation [26-40](#)
- RFC
  - 1065 [22-10](#)
  - 1066 [22-10](#)
  - 1067 [22-10](#)
  - 1213 [22-10](#)
  - 1907 [22-10](#)
  - 2571-2575 [22-10](#)
- rolling over log files [24-8](#)
  - overview [24-8](#)
- rollovernow command [24-8](#)
- root certificate
  - defined [A-3](#)
- root certificates
  - generating [11-8](#)
  - uploading [11-8](#)
  - using [A-8](#)
- routes
  - default route [25-5](#)
  - overview [25-4](#)
  - routing tables [25-6](#)
  - split routing [25-5](#)
- Routing Policies [17-5](#)
  - and URL category changes [17-5](#)
  - creating [10-5](#)
  - failover [10-2](#)
  - guest users [8-11](#)

- load balancing [10-2](#)
  - membership [10-4](#)
  - overview [10-1](#)
  - protocol of request [10-6](#)
  - proxy port of request [10-6](#)
  - subnet of request [10-7](#)
  - time of request [10-7](#)
  - URL category of request [10-7](#)
  - user agent of request [10-7](#)
  - user location of request [10-7](#)
  - Routing Policy groups
    - see also *policy groups*
  - routing tables
    - configuring [25-6](#)
  - routing traffic [10-1](#)
- 
- S**
- SaaS Access Control
    - authenticating users [15-2](#)
    - authentication requirements [15-4](#)
    - certificate [15-2](#)
    - configuring identity provider [15-5](#)
    - enabling [15-4](#)
    - identity provider [15-2](#)
    - identity provider initiated flow [15-2](#)
    - multiple appliances [15-5](#)
    - overview [15-1](#)
    - prompting for authentication [15-2](#)
    - SAML [15-1](#)
    - service provider [15-2](#)
    - service provider initiated flow [15-2](#)
    - single sign-on [15-10](#)
    - single sign-on URL [15-4](#)
    - understanding [15-1](#)
    - zero day revocation [15-1](#)
  - SaaS Application Authentication Policies
    - creating [15-8](#)
  - SaaS applications
    - see *SaaS Application Authentication Policies*
    - authentication requirements [15-4](#)
    - creating SaaS policies [15-8](#)
    - Metadata File for Service Provider [15-10](#)
    - single sign-on [15-10](#)
  - safe search
    - enforcing [17-17](#)
  - SAML
    - identity provider [15-2](#)
    - SaaS Access Control [15-1](#)
    - service provider [15-2](#)
  - scanning verdicts
    - anti-malware [24-38](#)
  - SCP Push [24-13](#)
  - search view
    - application control [18-5](#)
  - secure LDAP [20-26](#)
  - Secure Mobility
    - configuring from the CLI [14-4](#)
    - enabling [14-2](#)
    - logging [14-4](#)
    - overview [14-1](#)
    - remote users [14-2](#)
    - report [23-30](#)
    - transparent user identification [14-3](#)
  - see *upstream proxies*
  - self-signed certificate
    - defined [A-3](#)
  - SensorBase Network [2-11](#)
  - sequences
    - see *authentication sequences*
  - serial connection
    - connecting to the appliance [2-3](#)
  - service provider
    - defined [15-2](#)
  - service provider initiated flow
    - SaaS Access Control [15-2](#)
  - sethostname command
    - overview [25-1](#)

- setting up the appliance
  - prerequisites [4-1](#)
- Simple Network Management Protocol
  - see *SNMP*
- simplex
  - deploying the L4 Traffic Monitor [3-12](#)
  - network tap [4-2](#)
- single sign-on
  - see also *transparent user identification*
  - defined [20-5](#)
  - SaaS applications [15-10](#)
  - URL for SaaS access [15-4](#)
- site content rating
  - enforcing [17-17](#)
  - warning [17-18](#)
- SMI file
  - SNMP [22-11](#)
- SMTP transactions
  - logging [24-3](#)
- SNMP
  - community string [22-11](#)
  - hardware failure trap conditions [22-12](#)
  - hardware objects [22-11](#)
  - IPMI [22-11](#)
  - MIB file [22-11](#)
  - overview [22-10](#)
  - SMI file [22-11](#)
  - SNMPv1 [22-11](#)
  - SNMPv2 [22-11](#)
  - SNMPv3 passphrase [22-10](#)
  - specifying multiple trap targets [22-12](#)
  - traps [22-12](#)
- SOCKS
  - configuring [6-2](#)
  - enabling [6-2](#)
  - logging [6-4](#)
  - overview [6-1](#)
  - policies [6-2](#)
- Sophos scanning engine
  - overview [19-8](#)
- span port
  - deploying the L4 Traffic Monitor [3-12](#)
- special characters
  - authentication [20-36](#)
- splash page
  - web proxy usage agreement [5-13](#)
- split routing
  - defined [25-5](#)
- SSH
  - configuring host keys [24-10](#)
  - using with the CLI [27-1](#)
- SSL
  - negotiating a session [A-4](#)
  - used in HTTPS [A-3](#)
- SSL ciphers
  - configuring for administrator access [26-15](#)
- SSL handshake
  - overview [A-4](#)
- SSO URL
  - SaaS Access Control [15-4](#)
- standard service
  - WCCP service [25-12](#)
- Start Test button
  - overview [20-14](#)
- streaming upgrades [26-36](#)
- Submit button [26-2](#)
- submitting changes
  - configuring the appliance [26-2](#)
- subnet
  - Access Policies [6-3, 9-7](#)
  - Cisco IronPort Data Security Policies [13-8](#)
  - Decryption Policies [11-18](#)
  - External DLP Policies [13-8](#)
  - Outbound Malware Scanning Policies [12-5](#)
  - Routing Policies [10-7](#)
- supported languages
  - configuring default [26-14](#)
  - GUI and CLI [2-6](#)

supportrequest command [26-3](#)

surrogates

authentication [20-24](#)

symmetric key cryptography

defined [A-3](#)

Syslog [24-13](#)

System Capacity report

overview [23-36](#)

system configuration file [26-2](#)

System Setup Wizard

logging in [4-5](#)

Network page [4-6](#)

overview [4-4](#)

password [4-5](#)

Review page [4-13](#)

Security page [4-11](#)

Start page [4-6](#)

URL [4-5](#)

username [4-5](#)

System Status report [23-38](#)

system time [26-28](#)

---

## T

T1 and T2 interfaces

overview [3-3](#)

tabs in web interface [2-4](#)

tail command [24-10](#)

tcpdump

see *packet capture*

testauthconfig command [20-15](#)

testing authentication settings [20-13](#)

Threat Risk Threshold

Webroot [19-10](#)

time [26-28](#)

time based policies

overview [7-9](#)

time ranges [7-9](#)

URL Filters [17-21](#)

time ranges

Access Policies [6-3, 9-7](#)

creating [7-9](#)

Decryption Policies [11-18](#)

policy groups [7-9](#)

Routing Policies [10-7](#)

TLS

used in HTTPS [A-3](#)

tokens

see *variables*

to upstream proxies [10-1](#)

tracing policies

overview [7-12](#)

traffic

redirecting [17-19](#)

transaction result codes [24-17](#)

transparently identifying users

see *transparent user identification*

transparent mode

native FTP [5-9](#)

transparent redirection [25-11](#)

transparent redirection

adding a WCCP service [25-14](#)

assignment method [25-12](#)

forwarding method [25-13](#)

GRE forwarding method [25-13](#)

hash assignment [25-13](#)

HTTPS connections [3-6, A-2](#)

L2 forwarding method [25-13](#)

mask assignment [25-12](#)

overview [25-11](#)

WCCP services [25-12](#)

transparent user identification

Active Directory [8-13](#)

configuring [8-17](#)

Novell eDirectory [8-15](#)

overview [8-12](#)

remote users [14-3](#)

rules and guidelines [8-16](#)

- SaaS applications [15-10](#)
- Secure Mobility [14-3](#)
- `tuiconfig` CLI command [8-17](#)
- `tuistatus` CLI command [8-17](#)
- understanding [8-12](#)
- troubleshooting
  - policy groups [7-12](#)
- tty connection
  - connecting to the appliance [2-3](#)
- `tuiconfig` command
  - overview [8-17](#)
- `tuistatus` command
  - overview [8-17](#)

---

## U

- UDP\_MISS [6-4](#)
- uncategorized URLs
  - defined [17-2](#)
  - in reports [23-12](#)
  - URL submission tool [17-3](#)
- unlisted address
  - defined [21-1](#)
- unrecognized
  - root authority/issuer [11-11](#)
- unrecognized root authority
  - invalid certificates [11-11](#)
- updates
  - manual updates [26-40](#)
  - overview [26-35](#)
- upgrades
  - available [26-34](#)
  - configuring upgrade settings [26-35](#)
  - overview [26-33](#)
  - remote [26-37](#)
  - requirements for local upgrade servers [26-38](#)
  - streaming [26-36](#)
- upgrading
  - AsyncOS [26-33](#)
- uploading
  - certificate files [11-8, 15-6](#)
  - root certificates [11-8](#)
  - root certificates for HTTPS [A-8](#)
- upload request
  - defined [13-3](#)
- upstream proxies
  - adding proxy information [10-3](#)
  - authentication [20-2](#)
  - creating proxy groups [10-3](#)
  - deployment [3-10](#)
  - overview [10-1](#)
  - routing traffic [10-1](#)
- URL
  - Access Policies [9-7](#)
  - Cisco IronPort Data Security Policies [13-8](#)
  - Decryption Policies [11-18](#)
  - External DLP Policies [13-8](#)
  - Identity groups [8-4](#)
  - Outbound Malware Scanning Policies [12-5](#)
  - Routing Policies [10-7](#)
- URL categories [17-20](#)
  - abbreviations [17-25](#)
  - blocking [9-10, 13-11](#)
  - descriptions [17-25](#)
  - redirecting traffic [17-19](#)
  - uncategorized URLs [23-12](#)
- URL Categories report [23-10](#)
- URL category set
  - updates [17-4, 23-12, 26-2](#)
- URL Filters
  - bypassing [5-11](#)
  - configuring [17-9](#)
  - custom categories [17-15](#)
  - database [17-3](#)
  - Dynamic Content Analysis engine [17-2](#)
  - enabling [17-4](#)
  - no category [17-2](#)
  - regular expressions [17-23](#)



- time based [17-21](#)
  - URL category descriptions [17-25](#)
  - viewing filtering activity [17-22](#)
  - URL processing
    - L4 Traffic Monitor [21-1](#)
  - URL submission tool
    - using [17-3](#)
  - user accounts
    - about [26-8](#)
    - managing [26-9](#)
    - types of [26-9](#)
  - user agent
    - Decryption Policies [11-19](#)
    - Identity groups [8-4](#)
    - Routing Policies [10-7](#)
  - user agent based policies
    - overview [7-10](#)
  - user agent filtering
    - Access Policies [9-9](#)
  - user agents
    - Access Policies [9-7](#)
    - blocking [9-9](#)
    - Cisco IronPort Data Security Policies [13-9](#)
    - creating policies [7-11](#)
    - exempting from authentication [7-12](#)
    - External DLP Policies [13-9](#)
    - file types [9-14](#)
    - instant messenger [9-12](#)
    - objects [9-14](#)
    - Outbound Malware Scanning Policies [12-6](#)
    - peer-to-peer [9-14](#)
  - user defined notification pages
    - example [16-9](#)
    - overview [16-9](#)
    - parameters [16-10](#)
  - User Discovery Service log
    - Secure Mobility [14-4](#)
  - user location
    - Access Policies [9-7](#)
  - Cisco IronPort Data Security Policies [13-9](#)
  - Decryption Policies [11-19](#)
  - External DLP Policies [13-9](#)
  - Outbound Malware Scanning Policies [12-6](#)
  - Routing Policies [10-7](#)
  - user name [26-10](#)
  - usernames
    - making unrecognizable in reports [22-1](#)
  - user password length [26-9](#)
  - user passwords [26-11](#)
  - user preferences
    - defining [26-14](#)
  - user types [26-9](#)
- 
- ## V
- validating
    - certificates [11-6](#)
  - validating certificate authorities [A-5](#)
  - variables
    - access logs [24-28](#)
    - end-user notification pages [16-5](#)
  - VLAN
    - defined [25-6](#)
    - etherconfig command [25-7](#)
    - example use [25-7](#)
    - interfaceconfig command [25-10](#)
    - labels [25-7](#)
    - overview [25-6](#)
- 
- ## W
- W3C access logs
    - custom fields [24-37](#)
    - custom formatting [24-28](#)
    - log fields [24-27](#)
    - overview [24-26](#)
    - user defined log fields [24-37](#)

- warning
  - accessing adult content [17-18](#)
- warning page
  - end-user URL category page [16-15](#)
- warning users [17-20](#)
  - configuring end-user warning page [16-15](#)
  - using URL categories [17-20](#)
- WBRS
  - see also *Web Reputation Filters*
- WCCP
  - bypassing the web proxy [5-13](#)
- WCCP cluster
  - overview [3-10](#)
- WCCP configuration
  - example configuration [3-8](#)
  - syntax [3-7](#)
- WCCP router
  - cluster [3-10](#)
  - configuration syntax [3-7](#)
  - configuring [3-6](#)
  - connecting to the appliance [4-2](#)
  - deploying the appliance [3-6](#)
  - multiple [3-10](#)
  - WCCP services [25-12](#)
- WCCP services
  - adding [25-14](#)
  - assignment method [25-12](#)
  - deleting [25-15](#)
  - dynamic service [25-12](#)
  - editing [25-14](#)
  - forwarding method [25-13](#)
  - IP spoofing [25-13](#)
  - overview [25-12](#)
  - standard service [25-12](#)
  - well known service [25-12](#)
- web browsers
  - configuring [5-16](#)
  - detecting PAC files automatically [5-16](#)
  - PAC files [5-16](#)
  - supported [2-6](#)
- web interface
  - browser requirements [2-6](#)
  - clearing changes [2-9](#)
  - committing changes [2-9](#)
  - logging in [2-5](#)
  - navigating [2-4](#)
  - pages [2-5](#)
  - tabs [2-4](#)
  - user name and password [2-5](#)
- Web Proxy
  - restart effects [2-10](#)
- web proxy
  - advanced configuration [5-20](#)
  - bypassing [5-11](#)
  - cache [5-3](#)
  - cache, configuring [5-21](#)
  - deploying [3-1](#)
  - deploying in explicit forward mode [3-4](#)
  - deploying in transparent mode [3-5](#)
  - existing [3-10](#)
  - overview [5-1, 6-1](#)
  - splash page [5-13](#)
  - usage agreement [5-13](#)
- Web Proxy Autodiscovery Protocol
  - see *WPAD*
- web proxy cache
  - modifying [5-3](#)
  - removing a URL from the cache [5-3](#)
- Web Reputation Filters
  - about [19-2](#)
  - access log file [19-17](#)
  - access log information [24-21](#)
  - bypassing [5-11](#)
  - configuring Access Policies [19-13](#)
  - database [19-16](#)
  - how it works [19-2](#)
  - report [23-22](#)
  - scores [19-2](#)

Webroot scanning engine

- database [19-16](#)
- overview [19-6](#)
- Threat Risk Threshold [19-10](#)

Web Security appliance

- user name and password [2-5](#)

Web Sites report [23-8](#)

welcome page

- web proxy usage agreement [5-13](#)

well known service

- WCCP service [25-12](#)

whitelist address

- see *known allowed address*

whoami command [26-11](#)

who command [26-11](#)

Windows domain

- entering for authentication [20-3](#)

WPAD

- detecting PAC files [5-16](#)
- Internet Explorer [5-17](#)
- using with Netscape and Firefox [5-20](#)
- using with the appliance [5-17](#)

---

## X

X.509

- standard for certificates [A-3](#)

---

## Y

YouTube [5-6](#)

- headers [5-30, 24-28](#)

YouTube, logging added headers for [24-28](#)

---

## Z

zero day revocation

- defined [15-1](#)