

Cisco Meeting Server

Cisco Meeting Server Release 3.9 Single Combined Server Deployment Guide

May 16, 2024

Contents

What's new	9
1 Introduction	11
1.1 Supported Apps for joining Meeting Server hosted conferences	12
1.2 Using the Cisco Expressway-E as the Edge device in Meeting Server deployments	12
1.3 Using the Cisco Expressway-C with the Meeting Server in the core network	14
1.3.1 Using the Cisco Expressway H.323 gateway component	14
1.4 Using Meeting Server as the Edge device in Meeting Server deployments	14
1.5 How to use this guide	15
1.5.1 Commands	18
1.6 Configuring the Meeting Server	18
1.6.1 MMP and API Interfaces	19
1.6.2 New tools to ease configuring Meeting Server	19
1.7 Meeting Server licensing	22
1.7.1 Licensed features	22
1.7.2 Smart Licensing	23
1.7.3 Smart Account and Virtual Account information	24
2 General concepts for deployment	25
2.1 Web Admin	26
2.2 Call Bridge	27
2.3 Database	27
2.4 Web Bridge 3	27
2.5 TURN server	27
2.6 Meeting Server Edge	28
2.7 Recording meetings	29
2.7.1 License keys for recording	29
2.8 Streaming meetings	29
2.8.1 License keys for streaming	30
2.9 Hosting branding files locally	30
2.10 On screen messaging	30
2.11 SIP trunks and routing	31
2.12 Support for Lync and Skype for Business	31
2.12.1 Support for Lync and Skype for Business clients	31
2.12.2 Support for Dual Homed Conferencing	32

2.13	Web Scheduler	32
2.13.1	Scheduler in the web app UI	32
3	Prerequisites	34
3.1	Prerequisites for installing and configuring the Meeting Server	34
3.1.1	DNS configuration	34
3.1.2	Security certificates	34
3.1.3	Firewall configuration	34
3.1.4	Syslog server	34
3.1.5	Network Time Protocol server	35
3.1.6	Call Detail Record support	36
3.1.7	Host name	36
3.1.8	Other requirements	37
3.1.9	Specific prerequisites for a virtualized deployment	37
3.2	Meeting Server Edge hardware configuration	37
3.2.1	Edge server configurations	38
3.2.2	Deployment considerations	39
3.3	Network Planning for Meeting Server Edge	40
3.3.1	Technical description	40
3.3.2	Network planning	41
3.3.3	Deploying Meeting Server web edge	45
4	Configuring the MMP	47
4.1	Creating and managing MMP and Web Admin interface user accounts	47
4.2	Upgrading software	47
4.3	Configuring the Call Bridge	48
4.4	Configuring the Web Admin interface for HTTPS access	49
4.5	Stage Edge Server instances	50
4.6	Configuring Web Bridge 3	51
4.6.1	Useful information to help configure Web Bridge 3	52
4.6.2	Enabling the Web Bridge 3 Service	53
4.6.3	Configuring Call bridge C2W connections	55
4.6.4	Configure Call Bridge with Web Bridge Addresses	55
4.7	Configuring the TURN Server	57
4.7.1	Enable the TURN Service	57
4.7.2	Configure Call Bridge with TURN Addresses	59
4.8	LDAP authentication for MMP users	61

5	LDAP configuration	62
5.1	Why use LDAP?	62
5.2	Meeting Server settings	63
5.3	Example	66
5.4	Enforcing passcode protection for non-member access to all user spaces	67
6	Dial plan configuration – overview	69
6.1	Introduction	69
6.2	Web Admin Interface configuration pages that handle calls	70
6.2.1	Outbound calls page	70
6.2.2	Incoming call page: call matching	71
6.2.3	Call forwarding	72
6.3	Dial Transforms	73
7	Dial plan configuration – SIP endpoints	75
7.1	Introduction	75
7.2	SIP video endpoints dialing a meeting hosted on the Meeting Server	75
7.2.1	SIP call control configuration	75
7.2.2	Meeting Server configuration	76
7.3	Media encryption for SIP calls	78
7.4	Enabling TIP support	78
7.5	IVR configuration	79
7.6	Next steps	79
8	Dial plan configuration – integrating Lync/Skype for Business	80
8.1	Lync clients dialing into a call on the Meeting Server	80
8.1.1	Lync Front End (FE) server configuration	81
8.1.2	Adding a dial plan rule on the Meeting Server	82
8.2	Integrating SIP endpoints and Lync clients	83
8.3	Adding calls between Lync clients and SIP video endpoints	84
8.3.1	Lync Front End server configuration	85
8.3.2	VCS configuration	85
8.3.3	Meeting Server configuration	86
8.4	Integrating web app with SIP and Lync clients	88
8.5	Integrating Lync using Lync Edge service	88
8.5.1	Lync Edge call flow	89
8.5.2	Configuration on Meeting Server to use Lync Edge	90
8.6	Direct Lync federation	92

8.7	Calling into scheduled Lync meetings directly and via IVR	93
8.8	Choosing Call Bridge mode to connect participants to Lync conferences	95
9	Office 365 Dual Homed Experience with OBTP Scheduling	96
9.1	Overview	96
9.2	Configuration	96
9.3	In-conference experience	97
10	Settings for Web Bridge 3	98
10.1	Web Bridge 3 connections	98
10.1.1	Web Bridge 3 call flow	99
10.2	Web Bridge 3 settings	100
10.2.1	How to create and apply a web bridge profile example	100
11	Recording and Streaming meetings	104
11.1	Feature benefits of the new internal SIP recorder and streamer	104
11.2	Points to note when implementing the new internal SIP recorder and streamer ..	104
11.3	Recording overview	105
11.3.1	Third-party external SIP recorder support	106
11.3.2	Meeting Server internal SIP recorder component support	106
11.4	Example of deploying the new internal SIP recorder component on a VM server	108
11.5	Configuring an external third-party SIP recorder	111
11.6	Finding out recording status	112
11.7	Recording indicator for dual homed conferences	112
11.8	Recording with Vbrick	113
11.8.1	Prerequisites for the Meeting Server	114
11.8.2	Configuring the Meeting Server to work with Vbrick	115
11.9	Streaming meetings	117
11.10	Deploying the new SIP streamer component on a VM server	118
11.10.1	Known Limitations	121
12	Single Sign On (SSO) for Cisco Meeting Server web app	122
12.1	Configuring SSO for use on Meeting Server web app	122
12.1.1	Example 1 config.json file	126
12.1.2	Example 2 Simple service provider metadata file.	127
12.1.3	Example 3 Comprehensive service provider metadata file.	127
13	Support for ActiveControl	129
13.1	ActiveControl on the Meeting Server	129

13.2	Limitations	129
13.3	Overview on ActiveControl and the iX protocol	129
13.4	Disabling UDT within SIP calls	130
13.5	Enabling iX support in Cisco Unified Communications Manager	130
13.6	Filtering iX in Cisco VCS	131
13.7	iX troubleshooting	132
14	Scheduler - Deployment	133
14.1	Deploying the Scheduler	134
15	Additional security considerations & QoS	137
15.1	Common Access Card (CAC) integration	137
15.2	Online Certificate Status Protocol (OCSP)	137
15.3	FIPS	137
15.4	TLS certificate verification	138
15.5	User controls	138
15.6	Firewall rules	138
15.7	DSCP	139
15.8	Verifying SSH fingerprints	139
16	Diagnostic tools to help Cisco Support troubleshoot issues	141
16.1	SIP Tracing	141
16.2	Log bundle	141
16.3	Ability to generate a keyframe for a specific call leg	142
16.4	Reporting registered media modules in syslog	143
17	Additional licensing information	144
17.1	Licensing	144
17.1.1	How Smart licenses work in Meeting Server – overview	144
17.1.2	Expired license feature enforcement actions	146
17.1.3	How to retrieve licensing information (Smart Licensing)	147
17.1.4	Smart Licensing registration process	147
17.1.5	Multiparty licensing	148
17.1.6	Assigning Personal Multiparty licenses to users	149
17.1.7	How Cisco Multiparty licenses are assigned	150
17.1.8	Determining Cisco Multiparty licensing usage	150
17.1.9	Calculating SMP Plus license usage	151
17.1.10	Retrieving license usage snapshots from a Meeting Server	152

17.1.11 License reporting	152
17.1.12 Legacy licensing file method	152
18 Obtaining information on hosted conferences	154
18.1 Call Detail Records (CDRs)	154
18.2 Events	154
Appendix A DNS records needed for the deployment	156
Appendix B Ports required for the deployment	158
B.1 Configuring the Meeting Server	158
B.2 Connecting services	159
B.3 Using Meeting Server components	159
B.4 Ports open on loopback	162
Appendix C Call capacities by Cisco Meeting Server platform	163
C.1 Cisco Meeting Server web app call capacities	164
C.1.1 Cisco Meeting Server web app call capacities – external calling	164
C.1.2 Cisco Meeting Server web app call capacities – mixed (internal + external) calling	165
C.2 Number of users supported on Cisco Meeting Server	165
Appendix D Activation key for unencrypted SIP media	167
D.1 Unencrypted SIP media mode	167
D.2 Determining the Call Bridge media mode	168
Appendix E Dual Homed Conferencing	169
E.1 Overview	169
E.2 Consistent meeting experience in dual homed conferences	169
E.2.1 Summary of user experiences	170
E.3 Mute/unmute meeting controls in dual homed conferences	171
E.4 Configuring the Dual Homed Lync functionality	172
E.4.1 Troubleshooting	172
Appendix F More information on LDAP field mappings	174
Appendix G Using TURN servers behind NAT	176
G.1 Identifying candidates	176
G.1.1 Host candidate	176
G.1.2 Server Reflexive candidate	176

G.1.3 Relay candidate	177
G.2 Checking connectivity	179
G.3 NAT in front of the TURN server	180
Appendix H Using a standby Meeting Server	183
H.1 Backing up the currently used configuration	183
H.2 Transferring a backup to the standby server	183
Appendix I Web Admin Interface – Configuration menu options	185
I.1 General	185
I.2 Active Directory	185
I.3 Call settings	186
I.4 Outbound calls and Incoming calls	187
I.5 CDR settings	187
I.6 Spaces	188
I.7 API	188
Cisco Legal Information	190
Cisco Trademark	191

What's new

Version	Change
March 05, 2024	Updated for version 3.9
October 12, 2023	Removed references for multiple interfaces.
September 07, 2023	Updated for version 3.8 Updated information on expressway version.
June 6, 2023	Updated steps on Upgrade process.
March 16, 2023	Updated for version 3.7
August 23, 2022	Updated for version 3.6
June 2, 2022	Updated information on Single NIC configuration for TURN Server. Refer to NIC requirement
April 20, 2022	Updated for version 3.5
March 1, 2022	Updated the document for certificate name validation performed during Call Bridge cluster validation
December 15, 2021	Updated for version 3.4.
August 24, 2021	Updated for version 3.3.
August 25, 2021	Some sections in the guide have been restructured and rewritten to make them more comprehensive. This version includes several bug fixes.
June 02, 2021	Updated information on TURN Server ports and loopback interface.
May 19, 2021	Updated the document for web app call capacities and recommendations for Medium OVA Expressway.
April 21, 2021	Updated the TURN Server connections and Using Meeting Server components sections with port range details.
April 08, 2021	Updated for version 3.2. Call capacities by Cisco Meeting Server platforms updated.
March 15, 2020	Updated the document for short term credentials on the Meeting Server being a fully supported feature.
December 02, 2020	Minor correction.
November 30, 2020	New version for 3.1. Including: Cisco Meeting Server web edge information added. Single Sign On information added.
October 07, 2020	Minor correction.

Version	Change
September 02, 2020	Minor edit to clarify VM minimum requirement to 4 vCPU cores for Recorder/Streamer.
August 17, 2020	New version for 3.0. Removed deprecated components listed in 3.0 Release Notes.

1 Introduction

The Cisco Meeting Server software can be hosted on specific servers based on Cisco Unified Computing Server (UCS) technology or on a specification-based VM server. Cisco Meeting Server is referred to as the Meeting Server throughout this document.

Note: Cisco Meeting Server software version 3.0 onwards does not support X-Series servers.

A single combined Meeting Server deployment enables both SIP and web app participants to join meetings if participants have direct network access to the Call Bridge for signaling and media. This deployment works where all participants are within the same Intranet or network. This guide covers the Meeting Server deployed as a combined server deployment, the deployment has no scalability or resilience. The server comprises a number of components, see Figure 1.

Note: All of the Meeting Servers in the deployment must run the same version of software.

Note: Meeting Server 3.0 introduced a mandatory requirement to have Cisco Meeting Management 3.0 (or later). Meeting Management handles the product registration and interaction with your Smart Account (if set up) for Smart Licensing support. For more details on Smart Licensing, see [Section](#) .

Expressway (Large OVA or CE1200) is the recommended solution for deployments with medium web app scale requirements (i.e. 800 calls or less). Expressway (Medium OVA) is the recommended solution for deployments with small web app scale requirements (i.e. 200 calls or less). However, for deployments that need larger web app scale, from version 3.1 we recommend Cisco Meeting Server web edge as the required solution.

For more information on deploying the Meeting Server web edge solution, see [Section](#) .

Figure 1 shows the components available in a combined server deployment. Note that the Recorder, Uploader and Streamer components should be enabled on a separate server to that hosting the meetings. The Cisco Meeting Server 2000 schematic assumes that Cisco Expressway provides the TURN services.

Figure 1: Combined server deployment

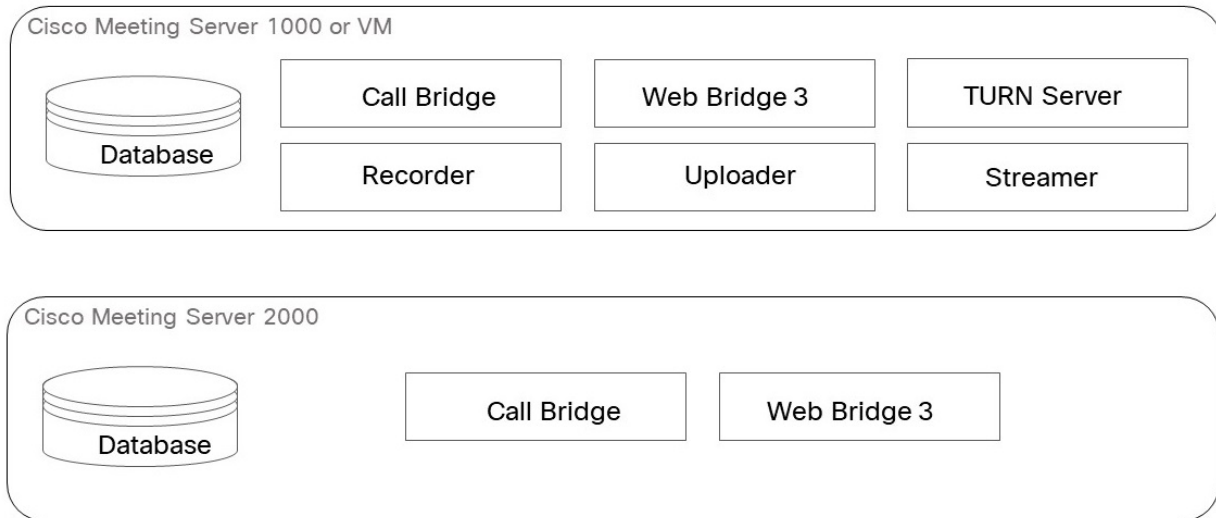

When used as an edge server, the Meeting Server uses its existing TURN server and web app components (and not the Call Bridge component), as shown in 1.

Not all of these components need to be configured, you only need to configure the components that are appropriate to your deployment. This is discussed in [Chapter](#) .

1.1 Supported Apps for joining Meeting Server hosted conferences

The Cisco Meeting Server web app and Cisco Jabber are the supported apps to join Meeting Server hosted conferences. This is in addition to SIP endpoints, and Lync/Skype for Business clients in dual homed conferences.

1.2 Using the Cisco Expressway-E as the Edge device in Meeting Server deployments

Expressway (Large OVA or CE1200) is the recommended solution for deployments with medium web app scale requirements (i.e. 800 calls or less). Expressway (Medium OVA) is the recommended solution for deployments with small web app scale requirements (i.e. 200 calls or less). However, for deployments that need larger web app scale, from version 3.1 we recommend Cisco Meeting Server web edge as the required solution.

Cisco Expressway software's Edge features have been developed to enable the Cisco Expressway-E to be used as the Edge device in Meeting Server deployments. The Cisco Expressway offers SIP firewall traversal, a reverse web proxy to support external participants joining Meeting Server conferences using the browser-based web app, and TURN Server capabilities to support media traversal for web app and remote Lync and Skype for Business clients.

In addition, the Cisco Expressway-E can be used as a SIP Registrar to register SIP endpoints or to proxy registrations to the internal call control platform (Cisco Unified Communications Manager or Cisco Expressway-C).

CAUTION: Important notes for Expressway users

If you are deploying Web Bridge 3 and web app, you must use Expressway version X14.3 or later. Earlier versions of Expressway are not supported by Web Bridge 3.

Note: Cisco Expressway-E can not be used between on premises Microsoft infrastructure and the Meeting Server. In deployments with on-premises Microsoft infrastructure and the Meeting Server, the Meeting Server must use the Microsoft Edge server to traverse Microsoft calls into and out of the organization.

Note: If you are configuring dual homed conferencing between on-premises Meeting Server and on-premises Microsoft Skype for Business infrastructure, then the Meeting Server automatically uses the TURN services of the Skype for Business Edge.

Table 1 below indicates the configuration documentation that covers setting up Cisco Expressway-E to perform these functions. Table 2 below shows the introduction of the features by release.

Table 1: Documentation covering Cisco Expressway as the edge device for the Meeting Server

Edge feature	Configuration covered in this guide
Connect remote browser based Meeting Server web apps	Cisco Expressway Web Proxy for Cisco Meeting Server Deployment Guide
Connect remote Lync and Skype for Business clients	Cisco Meeting Server with Cisco Expressway Deployment Guide
SIP Registrar or to proxy registrations to the internal call control platform	Cisco Expressway-E and Expressway-C Basic Configuration (X14.3)

Table 2: Expressway edge support for the Meeting Server

Cisco Expressway-E version	Edge feature	Meeting Server version
X14.3	Supports Cisco Meeting Server web app. See Cisco Expressway Web Proxy for Cisco Meeting Server (X14.3)	3.8 and later

1.3 Using the Cisco Expressway-C with the Meeting Server in the core network

In addition to deploying Cisco Expressway-E at the edge of the network, Cisco Expressway-C can be deployed in the core network with the Meeting Server. If deployed between the Meeting Server and an on-premises Microsoft Skype for Business infrastructure, the Cisco Expressway-C can provide IM&P and video integration. In addition the Cisco Expressway-C can provide the following functionality:

- a SIP Registrar,
- an H.323 Gatekeeper,
- Call control in Meeting Server deployments with Call Bridge groups configured to load balance conferences across Meeting Server nodes.

Table 3: Additional documentation covering Cisco Expressway-C and the Meeting Server

Feature	Configuration covered in this guide
Call control device to load balance clustered Meeting Servers	Cisco Meeting Server Load Balancing Calls Across Cisco Meeting Servers
SIP Registrar	Cisco Expressway-E and Expressway-C Basic Configuration (X14.3)
H.323 Gatekeeper	Cisco Expressway-E and Expressway-C Basic Configuration (X14.3)

1.3.1 Using the Cisco Expressway H.323 gateway component

In line with Cisco's goal of a single Edge solution across the Cisco Meeting Server and Cisco Expressway, Cisco has removed the H.323 Gateway component from version 3.0 of the Meeting Server software. Customers are encouraged to migrate to the more mature H.323 Gateway component in the Cisco Expressway.

Any H.323 endpoints registered to Expressway-E or Expressway-C will not consume Rich Media Session (RMS) licenses when calling into the Cisco Meeting Server from Expressway version X8.10 onwards.

1.4 Using Meeting Server as the Edge device in Meeting Server deployments

The Meeting Server Edge design requires you to deploy Edge instances of Meeting Server where they are reachable by external participants. This can be in your DMZ or public networks. Because this server is exposed to untrusted traffic, only essential services are enabled, and the recommended deployment is for the Edge instance to be deployed in the DMZ behind a NAT or firewall with selective rules allowing only required traffic. The Edge server in the DMZ must be

reachable by the Call Bridge servers deployed in the core. We recommend the DMZ/Intranet boundary be access controlled with only required traffic being allowed.

Web app client connectivity is achieved by having the Call Bridge connect outbound to the Web Bridge C2W interface using TLS to establish a secure control channel between the Core and Edge for Web Bridge functions. External browser clients connect to the Web Bridge in the Edge using HTTPS.

Media traffic for external web app clients is handled using a TURN relay setup through the Meeting Server's TURN server. After connecting to Web Bridge and being verified, web clients connect to the TURN server's listening port and request a relay transport address be allocated for them on the TURN server's interface. Using ICE, the client and Call Bridge validate they can send traffic through this relay to each other, and the resulting relay allows both parties to send and receive media across the network boundaries.

Using a TURN relay setup by the external client is the required deployment philosophy for the Edge server to achieve the published call capacities for Meeting Server Edge. Other combinations or scenarios may result in media connectivity being established but can result in reduced capacities and suboptimal media routing and therefore is not advised.

To reduce complexity, this guide only covers the scenario where the remote client establishes the relay.

Figure 2: Example of Meeting Server Edge TURN Server

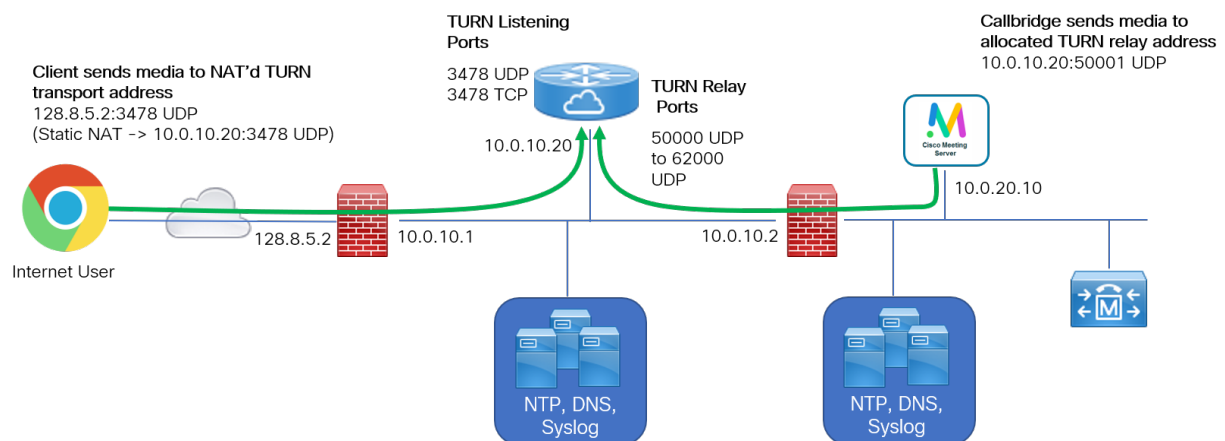

CAUTION: The Edge Meeting Server must stay within the DMZ and should not be directly connected to networks of different trust levels or security enclaves. The TURN server only needs one interface to perform its relay role.

1.5 How to use this guide

This deployment guide follows on from the appropriate Installation Guide for your server, and assumes that you have completed the installation instructions already. This guide should be

read and used in conjunction with the appropriate [Certificate Guidelines](#).

In addition to this deployment guide and the Certificate Guidelines, the reference material shown in the figure below can be found on the [Cisco Meeting Server documentation](#) page.

Note: Throughout this guide, the term coSpace is referred to as space.

Figure 3: Overview of guides covering the Meeting Server

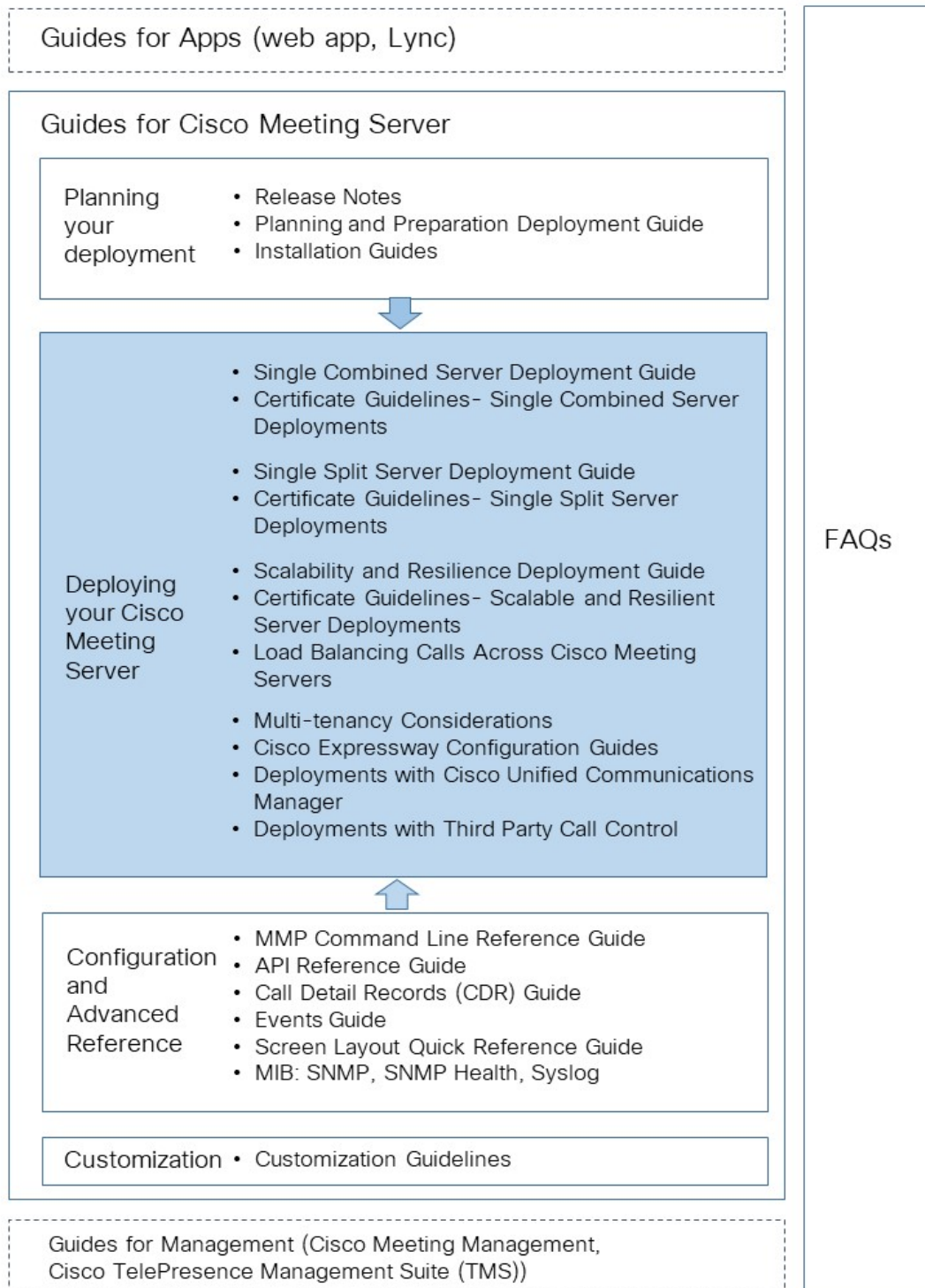

Note: The address ranges we use in Cisco user documentation are those defined in RFC 5737 which are explicitly reserved for documentation purposes. IP addresses in Meeting Server user documentation should be replaced with correct IP addresses routable in your network, unless otherwise stated.

1.5.1 Commands

In this document, commands are shown in black and must be entered as given—replacing any parameters in <> brackets with your appropriate values. Examples are shown in blue and must be adapted to your deployment.

1.6 Configuring the Meeting Server

There are two layers to the Cisco Meeting Server software: a Platform and an Application.

- **The Platform** is configured through the Mainboard Management Processor (MMP). The MMP is used for low level bootstrapping, and configuration via its command line interface. For example, the MMP is used to enable the Web Bridge, Database clustering, and for various other components.
- **The Application** runs on the MMP platform. Administration of the application level (call and media management) can be done via the Call Bridge's Web Admin interface or through the Application Programming Interface (API) if you prefer. The API uses HTTPS as a transport mechanism and is designed to be scalable in order to manage the potentially very large numbers of active calls and spaces available in a deployment.

From version 2.9, the application level administration can all be done via the [Call Bridge's Web Admin Interface](#) both for single and clustered Meeting Servers.

1.6.1 MMP and API Interfaces

Table 4: Network interfaces configured for the MMP and API on the different Meeting Server platforms

Platform	Access to MMP	Access to Web Admin interface and API
Cisco Meeting Server 2000	Serial over LAN (SoL) connection on blade 1. Note: Before accessing the MMP you need to configure the network settings for the Fabric Interconnect modules	Interface A created during the configuration of MMP. It is a virtual connection that is connected to the external network through uplinks configured on Port 1 of the Fabric Interconnect modules. Note: Cisco Meeting Server 2000 platform does not support more than one interface (i.e. configuring 'ipv4 b c d' is not supported).
Cisco Meeting Server 1000 and other virtualized deployments	Virtual interface A	One Ethernet interface (A) is created, but up to three more can be added (B, C and D). The Call Bridge Web Admin interface and the API can be configured to run on any one of the A-D Ethernet interfaces.

1.6.2 New tools to ease configuring Meeting Server

The following tools are available to help administrators configure and deploy Meeting Server:

- [Installation Assistant](#) Simplifies the creation of a simple Cisco Meeting Server installation for demonstrations, lab environments, or as the starting point for basic installations. From version 3.3 onwards, Installation Assistant is not longer a standalone tool. It is integrated with Meeting Management and can be used from the Meeting Management UI.
- [Provisioning Cisco Meeting Server web app users through Cisco Meeting Management](#), available from version 2.9.
- [API access through the Meeting Server web interface](#). From version 2.9, the Meeting Server API can be accessed via the **Configuration** tab of the Meeting Server Web Admin interface. Some examples in this guide have been changed from using API methods POST and PUT, to using API access through the web interface.

Installation Assistant tool

Use the Installation Assistant to simplify the creation of a single Cisco Meeting Server installation for demonstrations, lab environments, or as the starting point for basic installations. The tool configures Meeting Server based on the best practice deployment described in the [Cisco Meeting Server Single Server Simplified Deployment guide](#). From version 3.3 onwards, it is integrated with Meeting Management to collect information about your setup and then pushes that configuration to the server without you needing to use utilities to access the API, SFTP or the Meeting Server's command line interface. The Installation Assistant can be run from the Meeting Management UI. Refer to the Meeting Management Installation Guide for the software requirements for the client computer, details on installing and running the software, and the steps to configuring a Meeting Server.

Installation Assistant configures Meeting Server to be a SIP MCU capable of making and receiving calls and optionally enables the Cisco Meeting Server web app.

Installation Assistant is intended to be used on an empty, non-configured Meeting Server. It is not a management tool for Meeting Server, nor is it for re-configuring existing Meeting Server installations. The tool is built for configuring Meeting Server virtual machines only. It is not for use with the Cisco Meeting Server 2000 platform.

Using Cisco Meeting Management to provision Cisco Meeting Server web app users

Cisco Meeting Management connected to a Meeting Server or Meeting Server cluster, provides the facility to provision LDAP authenticated Cisco Meeting Server web app users, rather than needing to use the Meeting Server API. The feature also allows admins to create space templates that can be used by web app users to create their own space.

Refer to the [Cisco Meeting Management User Guide for Administrators](#) for information on connecting LDAP servers to Meeting Server clusters, how to add one or more user imports, how to create a space template, reviewing and committing the changes and finally running the LDAP sync.

API access on the web interface

To simplify using the Call Bridge API without the need for third-party applications, version 2.9 introduced a user interface for the Call Bridge API that can be accessed via the **Configuration** tab of the Meeting Server web interface, as shown in Figure 4.

The Scheduler APIs introduced in version 3.3 are not supported via this interface. See [Accessing Scheduler APIs](#).

Note: To access the API via the web interface you still need to do the initial Meeting Server configuration settings and authentication using the MMP as you would if you were using a third party application. See the [MMP Command reference guide](#) for details.

Figure 4: Accessing the Call Bridge API via the Meeting Server web interface

The screenshot shows the Cisco Meeting Server web interface. At the top left is the Cisco logo. Below it is a navigation bar with tabs for 'Status', 'Configuration', 'Logs', and 'Debug'. The 'Configuration' tab is active. On the right of the navigation bar, the user is identified as 'admin'. A dropdown menu is open under 'Configuration', listing various settings categories: General, Active Directory, Call settings, Outbound calls, Incoming calls, Interactive Voice Response, CDR settings, and Spaces. The 'API' option is selected, and a list of API endpoints is displayed. The list includes paths like /api/v1/callBrandingProfiles/<id>, /api/v1/callBridgeGroups/<id>, /api/v1/callBridges/<id>, /api/v1/callLegProfiles/<id>, /api/v1/callLegs/<id>, /api/v1/callLegs/<id>/callLegProfileTrace, /api/v1/callLegs/<id>/cameraControl, /api/v1/callLegs/<id>/generateKeyframe, /api/v1/callProfiles/<id>, /api/v1/calls/<id>, /api/v1/calls/<id>/calllegs, /api/v1/calls/<id>/calllegs/<id>, and /api/v1/calls/<id>/diagnostics. On the right side of the API list, there are two buttons: 'Allow delete' and 'Disallow delete'. Below these buttons is a checkbox labeled 'Require delete confirmation' which is checked.

Note: If you wish to delete any configured API objects, select **Allow delete** on the right-hand side of the screen. By default, deletion is disallowed and **Require delete confirmation** is checked to help prevent unintentional deletions.

Using the API via the web interface offers a user-friendly way to work with the API as it gives a more visual approach to configuring your Meeting Server. For example, configuring callProfiles can be achieved using the check boxes and fields shown in Figure 5.

Figure 5: Configuring callProfiles using API access on the web interface

1.7 Meeting Server licensing

You will need licenses to complete a setup of the Cisco Meeting Server. Meeting Server requires license management through the Cisco Meeting Management product and supports Cisco Smart Licensing. From the 3.4 release onwards, Smart licensing is mandatory for Meeting Server. The support for traditional licensing has been deprecated from 3.4 and later releases. Customers are advised to move to Smart licensing.

Note: In an environment where you cannot use Meeting Management or connect to the internet due to security reasons, contact your Cisco Account team for alternate licensing options.

This chapter covers licensed features, Smart licensing, and information about Smart accounts and virtual accounts. You can find more information about licensing in [this section](#).

1.7.1 Licensed features

The following Meeting Server features require a license:

- Call Bridge
- Call Bridge [No Encryption Support]
- Customizations (for custom layouts)
- Recording or Streaming
- Snapshot of participants in the meeting

In addition to feature licenses, user licenses also need to be purchased, there are 2 different types of user licenses:

- Personal Multiparty Plus (PMP Plus)
- Shared Multiparty Plus (SMP Plus)

See [Multiparty licensing](#) for more information.

Note: With Cisco Meeting Management, you can use Trial Mode for a 90 day full featured period without licenses.

1.7.2 Smart Licensing

Version 3.0 of Meeting Server introduced support for Smart Licensing on Cisco Meeting Server using Cisco Meeting Management version 3.0 (or later). This transition to the software licensing model, i.e. moving from traditional Product Activation Key (PAK) licenses to Smart Licensing, improves the user experience of license purchasing, registration and software administration. It also aligns Meeting Server with other Cisco products' approach to software licensing and utilizes Cisco Smart Account – a central repository where you can view, store, and manage licenses across your entire organization.

Note: Cisco Smart Licensing Cloud Certificates will be updated in February 2023. After the update, all communications directly with Smart Licensing cloud or through Cisco Smart Software manager (SSM) on-prem will be impacted. It is recommended to upgrade to Meeting Management 3.6 before Feb 2023. SLR/PLR customers should also upgrade to Meeting Management 3.6 for getting new licenses, performing manual sync or adding a new call bridge.

All new license purchases still receive a PAK code – retain for reference – as all licenses will be available in the Smart Account that Meeting Management will sync to.

For further information and to create a Smart Account, go to: <https://software.cisco.com> and choose Smart Licensing.

The Meeting Server licensing changes from versions prior to 3.0 are:

- Cisco Meeting Management version 3.0 (or later) is mandatory in version 3.0 – Meeting Management reads the Meeting Server license file, and can handle the product registration and interaction with your Smart Account (if set up).
- You can now license multiple clusters with one set of Meeting Server licenses in your Smart Account and you no longer need to load the license file onto each individual Meeting Server instance as was the case prior to 3.0.
- Meeting Management with Smart Licensing tracks how many Call Bridges per cluster, thereby eliminating the need for the R-CMS-K9 activation license.
- For a new deployment with no existing licenses:

- Newly purchased licenses may be Smart-enabled by default and require a Smart Account – once you have entered the license details into Meeting Management, it will validate the license details against those held in the Smart Account.
- For an existing deployment with a local license file on each Call Bridge:
 - You can move to a Smart Account using the Cisco Smart Software Manager (CSSM) portal and choose the option to convert your existing licenses to Smart.
- SMP Plus and PMP Plus license usage is combined to decide if a day is counted as overage (if either license is over, the whole day is regarded as usage higher than the entitlement). For other feature licenses (for example, recording or custom layout), they are assessed separately and enabled with entitlement via Meeting Management (assuming the license exists in your Smart account).

Note: The term " overage" is used to describe a situation where license usage is higher than the entitlement.

Note: As Meeting Management is required for all 3.0 deployments, for larger customer deployments, Meeting Management can be deployed in new licensing-only mode without active meeting management.

1.7.3 Smart Account and Virtual Account information

Smart Accounts can contain Virtual Accounts which allow you to organize your licenses by any designation of your choice, for example, by department. Here are some important points to note when using a Smart Virtual Account with Meeting Server and Meeting Management:

- Each Meeting Server cluster(s) to a single Meeting Management should be linked to a user-defined Smart Virtual Account.
- Each Virtual Account can only connect with a single Meeting Management server that is configured to handle Smart Licensing.
- Only configure a single Meeting Management to Smart – we recommend you do **not** configure a second redundant Meeting Management for Smart Licensing as double counting of license usage will occur.
- PMP Plus, SMP Plus, and Recording/Streaming licenses can be shared across multiple clusters with a single Meeting Management instance and Smart Licensing in a single Virtual Account.
- ACU licensing is not available with the Meeting Management licensing dashboard – ACUs are not supported in 3.0 and later.

For more information about licensing, see [Additional licensing information](#).

2 General concepts for deployment

This chapter provides an overview of the general concepts for deploying the Meeting Server in a combined server deployment. Figure 6 illustrates a typical deployment with Cisco Expressway in the DMZ.

Expressway (Large OVA or CE1200) is the recommended solution for deployments with medium web app scale requirements (i.e. 800 calls or less). Expressway (Medium OVA) is the recommended solution for deployments with small web app scale requirements (i.e. 200 calls or less). However, for deployments that need larger web app scale, from version 3.1 we recommend Cisco Meeting Server web edge as the required solution.

Figure 6: Example of a Meeting Server deployment with Cisco Expressway at the edge

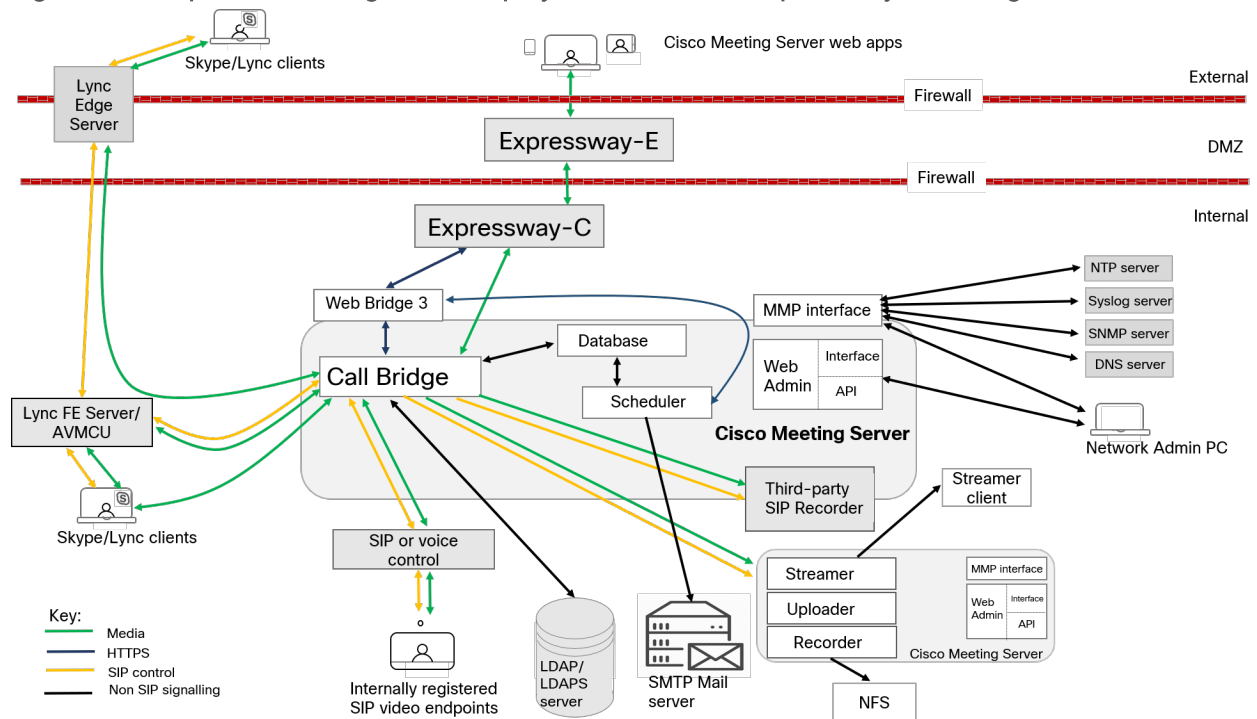

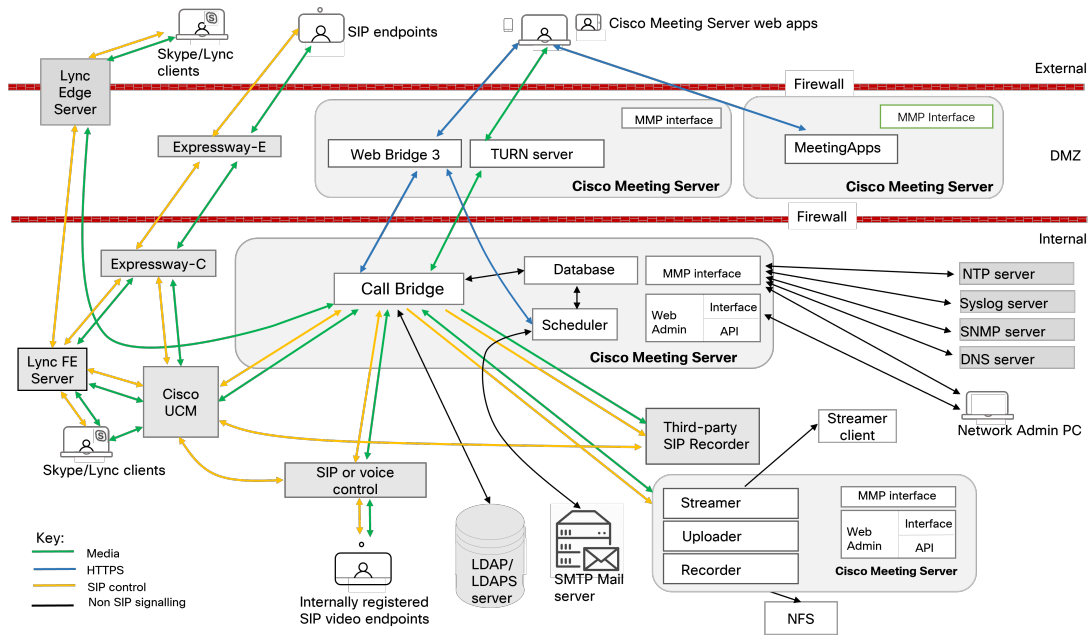

Note:

- The Meeting Server includes a Recording facility and a Streaming facility. Enable the Recorder/Streamer on the same server as the Call Bridge only if you are evaluating the features, as this will result in a drop in the connection 15 minutes after the call is initiated. For normal deployment enable the Recorder/Streamer on a different server to the Call Bridge. If you intend to deploy the Recorder and Streamer on the same Meeting Server, you will need to size the server appropriately for both uses. For more information on recording and streaming, see [Section 11](#).

2.1 Web Admin

The Web Admin is a web based interface to configure the Meeting Server.

After configuring the Web Admin Interface for HTTPS access, as described in the Meeting Server installation guide, type the hostname or IP address of the server in a web browser to reach the login screen of the Web Admin Interface. See [Web Admin Interface – Configuration menu options](#) for details of the configuration accessible through the Web Admin Interface. From version 2.9, the **API** can be accessed via the **Configuration** tab of the Web Admin Interface.

In addition to providing an administrator web page for Meeting Server, Web Admin also provides the interface for the REST API for Meeting Server. The REST API can be accessed with any conventional REST tool such as Postman or Chrome Poster. Starting with version 2.9, the Web Admin interface includes an API Explorer interface that allows administrators to work with the Meeting Server API without additional tools/software. The API Reference Guide is available [here](#).

2.2 Call Bridge

The Call Bridge is the component on the Meeting Server that bridges the conference connections, enabling multiple participants to join meetings hosted on the Meeting Server or Lync AVMCUs. The Call Bridge exchanges audio and video streams so that participants can see and hear each other. The Call Bridge does not require licensing to operate.

2.3 Database

The Call Bridge reads from and writes to the database storing the space information, for example, the members of spaces, and recent activity within a space.

2.4 Web Bridge 3

Web Bridge 3 is a Meeting Server component that enables participants to join meetings using the browser-based Cisco web app client. Web Bridge 3 provides the web server for Cisco Meeting Server web app participants and works in conjunction with the Call Bridge and TURN Server components to support clients. The original Web Bridge 2 component and Cisco Meeting App for WebRTC are removed as of version 3.0. Cisco Meeting App for desktop and iOS are also no longer supported and are replaced by Cisco Meeting Server web app.

Note: If you are not using the web app, you do not need to deploy Web Bridge 3.

If you are using the web app (i.e. you have deployed Web Bridge 3), see [Cisco Meeting Server web app Important Information](#) for details on when features are released and issues resolved for the web app. All information relevant to the web app is contained in this separate document and is not included in the Meeting Server release notes.

The Important Information guide describes the following:

- Any new or changed feature in the web app, and details of fixed issues and open issues associated with the web app with an indication of the version of Meeting Server where this feature/fix is available.
- Any upcoming changes in browsers affecting the web app, and the affected versions of the web app with recommended workarounds.

Note: There is no automatic upgrade migration from Web Bridge 2 to Web Bridge 3. If you have already deployed Web Bridge 3 in version 2.9, you should check your settings after upgrade because they will not be migrated across from the Web Admin or old settings in `/webBridges/<webbridge id>`.

2.5 TURN server

The TURN server provides firewall traversal technology, allowing the Meeting Server to be deployed behind a Firewall or NAT. To connect to the deployment from Meeting Server web app, external Lync clients, or SIP endpoints registered to a SIP or voice call control device, you need to enable the TURN server, refer to the sections on [Configuring the MMP](#) and [Web Admin Interface Settings for the TURN Server](#). If you are using Cisco Meeting Server web apps you also need to configure the Web Admin interface to allow the Call Bridge and external clients to access the TURN server. Using the TURN server does not require a license.

The TURN server listens on port 3478 for UDP connections from the Call Bridge, and is also available for remote connections.

The TURN server can also listen on a second port for TCP from client connections, typically 443 (requires 'turn tls <port>' configuration).

Although the Meeting Server configuration option for enabling TURN TCP is named "tls", TURN TLS is not used by Meeting Server or web app. Web app uses TCP or UDP and Call Bridge always uses UDP (Media is encrypted using SRTP).

Ensure your firewall rules permit UDP port 3478 from the Call Bridge to the TURN server.

Media sent over TCP is encrypted using SRTP. The TURN server supports TCP to UDP interworking (see Figure 7). A browser can send TCP media to the TURN server which converts it to standard UDP media. This is useful when UDP traffic from browsers is blocked.

Figure 7: TURN server supporting TCP and UDP

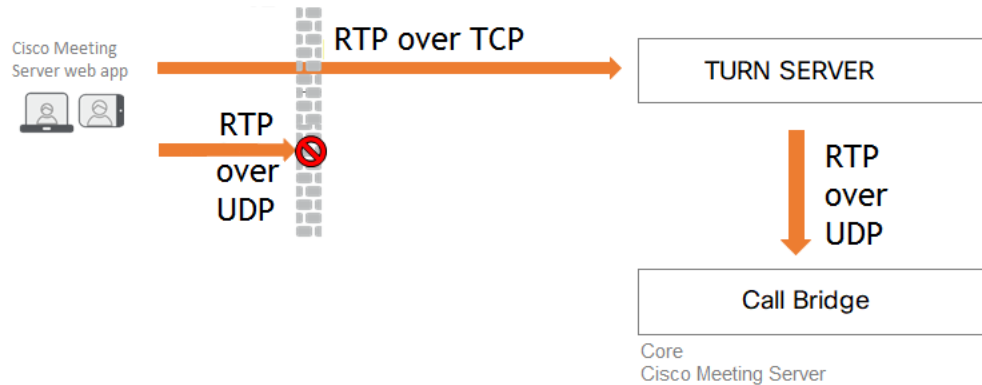

The TURN server in a combined server deployment must be configured to listen on the loopback interface. See [Section 4](#) for details.

2.6 Meeting Server Edge

Meeting Server Edge or CMS Edge is the label used to describe a limited role Meeting Server instance deployed in the DMZ or external network to be the point of contact for external web app participants. One or more limited-service instances of Meeting Server are deployed in your DMZ or external network to be the 'Edge' role and work in conjunction with Meeting Server

instances deployed in the internal network – the ‘Core’. The CMS Edge should only have Web Bridge 3 and TURN services enabled on it. This deployment scenario is a high-capacity alternative to using the Cisco Expressway as the proxy and TURN Server for external web app participants. The Meeting Server Edge deployment model does not address SIP firewall traversal needs – traversal needs for SIP calling must be addressed separately using Cisco Expressway or other SIP calling technologies. A typical Meeting Server Edge deployment would use Cisco Expressway for SIP calling and the Meeting Server Edge functionality for Cisco web app participants.

2.7 Recording meetings

Prior to 3.0, Meeting Server's internal recorder and streamer components were dependent upon the Meeting Server's internal XMPP server component – in 3.0 this XMPP server is removed. Version 3.0 introduces a new internal recorder and streamer, both SIP-based.

The new internal recorder and streamer components and dialing out to third-party SIP recorders are all configured using SIP URIs, so when recording or streaming is started the administrator-configured SIP URI is called.

The internal SIP Recorder component (from version 3.0) on the Meeting Server adds the capability of recording meetings and saving the recordings to a document storage such as a network file system (NFS).

For more information on recording meetings, see [Section 11](#).

2.7.1 License keys for recording

You will need one or more licenses for recording. One ‘recording’ license supports 1 concurrent streaming or 1 recording, existing recording licenses will allow streaming. Contact your Cisco sales representative or partner to discuss your licensing requirements.

2.8 Streaming meetings

The internal SIP Streamer component (from version 3.0) adds the capability of streaming meetings held in a space to the RTMP URL configured on the space.

An external streaming server needs to be configured to be listening on this RTMP URL. The external streaming server can then offer live streaming to users, or it can record the live stream for later playback.

Note: The Streamer component supports the RTMP standard in order to work with third party streaming servers that also support the RTMP standard. Vbrick is the officially supported external streaming server, however, other servers have also been tested.

Version 3.1 extends the RTMP support in the internal SIP streamer application to RTMPS – essentially RTMP over a TLS connection. Previously all traffic between the streamer and RTMP server was unencrypted, 3.1 RTMPS support allows this traffic to be encrypted.

The existing `tls` MMP command is extended to optionally allow configuration of TLS trusts for RTMPS. This step is optional but recommended. If a TLS trust is not configured then the RTMPS connection will not be secure.

2.8.1 License keys for streaming

You will need one or more licenses for streaming. One ‘recording’ license supports 1 concurrent streaming or 1 recording, existing recording licences will allow streaming. Contact your Cisco sales representative or partner to discuss your licensing requirements.

2.9 Hosting branding files locally

One set of branding files can be held locally on the Meeting Server. These locally hosted branding files are available to the Call Bridge and Web Bridge once the Meeting Server is operational, removing the risk of delays in applying customization due to problems with the web server. The images and audio prompts replace the equivalent files built into the Meeting Server software; during start up, these branding files are detected and used instead of the default files. Locally hosted branding files are overridden by any remote branding from a web server.

You can change these locally hosted files simply by uploading a newer version of the files and restarting the Call Bridge and Web Bridge. If you remove the locally hosted files, the Meeting Server will revert to using the built-in (US English) branding files after the Call Bridge and Web Bridge have been restarted, providing a web server has not been set up to provide the branding files.

Note: To use multiple sets of branding files, you still need to use an external web server.

For more information on hosting branding files locally, see the [Cisco Meeting Server Customization Guidelines](#).

2.10 On screen messaging

The Meeting Server provides the ability to display an on-screen text message to participants in a meeting hosted on the Meeting Server; only one message can be shown at a time. Using the API, the duration that the message is displayed can be set, or made permanent until a new message is configured. Use the `messageText`, `messagePosition` and `messageDuration` parameters for API object `/calls`.

For users of SIP endpoints and Lync/Skype for Business clients, the on-screen text message is displayed in the video pane. The position of the message in the video pane can be selected from top, middle or bottom.

On screen messaging is also sent to other devices that are using ActiveControl in the deployment, for instance CE8.3 endpoints, and individual Meeting Servers not in a cluster but with the in-call message feature enabled. Meeting Servers in a cluster also support on screen messaging through a proprietary mechanism.

2.11 SIP trunks and routing

The Meeting Server requires SIP trunks to be set up from one or more of the following: SIP Call Control, Voice Call Control and Lync Front End (FE) server. Changes to the call routing configuration on these devices are required to route calls to the Meeting Server that require the Web Bridge service for interoperability.

2.12 Support for Lync and Skype for Business

2.12.1 Support for Lync and Skype for Business clients

You can use Skype for Business clients, and Lync 2010 and Lync 2013 clients connected to a Skype for Business server, Lync 2010 or 2013 server. From version 2.6, the Meeting Server supports Skype for Business 2019.

The Meeting Server uses:

- the RTV codec transcoding up to 1080p with the 2010 Lync Windows client and 2011 Lync Mac clients,
- the H.264 codec with the 2013 Lync Windows client and Skype for Business client.

The Meeting Server will provide both RTV and H.264 streams when a mixture of clients versions are connected.

Lync 2010 and 2013 clients and Skype for Business clients can share content. The Meeting Server transcodes the content from native Lync RDP into the video format used by other participants in the meeting and sends it as a separate stream. Lync and Skype for Business clients also receive content over a RDP stream and can display it separately from the main video.

The Lync FE Server will need a Trusted SIP Trunk configured to route calls originating from Lync endpoints through to the SIP video endpoints i.e. to route calls with destination in the SIP video endpoint domain through to the Call Bridge.

The SIP Call Control will require configuration changes to route calls destined to the Lync/Skype for Business client domain to the Call Bridge so that SIP video endpoints can call Lync/Skype for Business clients.

The dial plan routes Lync/Skype for Business calls between these two domains in both directions.

The Meeting Server includes support for Lync Edge to enable Lync/Skype for Business clients outside of your firewall to join spaces.

Dual homed conferencing functionality improves how the Meeting Server communicates with the Lync AVMCU, resulting in a richer meeting experience for both Lync/Skype for Business and Cisco Meeting Server web app users. [Appendix E](#) describes the dual homed conference experience.

2.12.2 Support for Dual Homed Conferencing

Dual homed conferencing requires the Lync Edge settings to be configured on the Lync Edge server settings on the Meeting Server for conference lookup. If you already have an on-prem Lync deployment or Lync Federation deployment working with the Meeting Server deployment, then no additional configuration is required on the Meeting Server. If this is a new deployment, then you need to setup the Meeting Server to use the Lync Edge server, see [Chapter 8](#).

For information on the features which improves the experience of participants in Lync/Skype for Business meetings, see:

- [FAQ on the improvements in meeting experience for Lync participants](#),
- [FAQ on RDP support](#),
- [FAQ on multiple video encoder support](#).

2.13 Web Scheduler

The Scheduler is a Meeting Server component that allows end users to schedule meetings via the web app. It is supported on Meeting Server 1000, Meeting Server 2000 and Meeting Server on VM deployments. For Meeting Server on specification-based VM platforms, an additional 4 GB of RAM is required for running the scheduler component. There is no additional RAM requirement for Meeting Server 1000 and Meeting Server 2000. Scheduler supports sending email notifications via configuration of an SMTP email server. For more information on email server configuration, see Cisco Meeting Server [Installation Guides](#).

One scheduler supports 150,000 meetings; two or three schedulers can be added to provide resiliency but the capacity remains at 150K scheduled meetings. Scheduled meeting data is stored in the Meeting Server database and both clustered and single box database deployments are supported.

For more information, see [Scheduler - Deployment](#).

2.13.1 Scheduler in the web app UI

- The user interface for scheduling meetings will be displayed to web app users, provided at least one scheduler has established a connection to the Web Bridge. If no schedulers

are enabled then the web app user will not see the user interface for scheduling meetings.

- When the administrator adds, removes, or changes Web Bridges via the Call Bridge /Web Bridges API, the scheduler does not automatically become aware of those changes. Therefore, the schedulers must be restarted. Similarly, when a scheduler is disabled, the Web Bridges are not aware that the scheduler is purposely disabled rather than just down for some unexpected reason. If the scheduler is intentionally disabled by the administrator, a restart of the Web Bridges is recommended so that the scheduling user interface is not displayed.
- When a scheduler is down due to being disabled or some other issue, the Web Bridge uses a different scheduler if available. Otherwise, an error is displayed to the web app users.

3 Prerequisites

3.1 Prerequisites for installing and configuring the Meeting Server

This chapter describes the changes to your network configuration that you need to consider before installing and configuring the Meeting Server; some of these items can be configured beforehand.

3.1.1 DNS configuration

The Meeting Server needs a number of DNS SRV and A records. See [Appendix A](#) for a full list, but specific records are also mentioned elsewhere.

3.1.2 Security certificates

You will need to generate and install X.509 certificates and keys for services which use TLS; for example, Call Bridge, Web Admin Interface (the Call Bridge's interface), Web Bridge 3, TURN server.

The [Certificates Guidelines](#) for combined deployments contains both background information on certificates and instructions, including how to generate self-signed certificates using the Meeting Server's MMP commands. These certificates are useful for testing your configuration in the lab. However, in a production environment we **strongly recommend** using certificates signed by a Certificate Authority (CA).

Instructions that were previously in this guide concerning certificates have been removed and replaced by a single step referencing the [Certificate Guidelines](#).

Note: If you self-sign a certificate, and use it, you may see a warning message that the service is untrusted. To avoid these messages re-issue the certificate and have it signed by a trusted CA: this can be an internal CA unless you want public access to this component.

3.1.3 Firewall configuration

See [Appendix B](#) for the list of ports which need to be opened on your firewall, and [Section 15.6](#) for advice on creating Firewall rules.

3.1.4 Syslog server

The Meeting Server creates Syslog records which are stored locally and can also be sent to a remote location. These records are useful when troubleshooting because they contain more detailed logging than is available on a Meeting Server's own internal log page. Internal syslog

messages can be downloaded over SFTP, however Cisco recommends that the host server is configured to send debug information to a remote Syslog server.

Note: The Syslog server must use TCP, not UDP. Check that your Syslog server is configured to use TCP.

Follow the instructions below to define a Syslog server.

1. SSH into the MMP and log in.
2. Enter the following command, `syslog server add <server address> [port]`

Examples:

```
syslog server add syslog01.example.com 514
syslog server add 192.168.3.4 514
```

3. Enable the Syslog server by entering:

```
syslog enable
```

4. Optionally, if you want to send the audit log to a Syslog server follow these steps.

(The audit log facility records configuration changes and significant low-level events. For example, changes made to the dial plan or configuration of a space via the Web Admin Interface or the API, are tracked in this log file, and tagged with the name of the user that made the change along with the respective source IP address and SSH port. This enables identifying the source of events, especially in concurrent sessions. The file is also available via SFTP.)

- a. Create a user with the audit role.

```
user add <username> (admin|crypto|audit|appadmin)
user add audituser audit
```

- b. Log out of the MMP and log back in with the newly created user account.

- c. Enter the command (this command can only be run by a user with the audit role):

```
syslog audit add <servername>
syslog audit add audit-server.example.org
```

Note: Normally local Syslog files are overwritten in time, but you can permanently store system and audit log files using the `syslog rotate <filename>` and `syslog audit rotate <filename>` commands. These files can also be downloaded over SFTP. See the MMP Command Reference.

3.1.5 Network Time Protocol server

Configure a Network Time Protocol (NTP) server to synchronize time between the Meeting Server components.

Note: Sharing a common view of time is important for multiple reasons, it is necessary when checking for certificate validity and to prevent replay attacks.

1. If necessary, SSH into the MMP and log in.

2. To set up an NTP server, type:

```
ntp server add <domain name or IP address of NTP server>
```

To find the status of configured NTP servers, type `ntp status`

See the [MMP Command Reference](#) for a full list of `ntp` commands.

3.1.6 Call Detail Record support

The Meeting Server generates Call Detail Records (CDRs) internally for key call-related events, such as a new SIP connection arriving at the server, or a call being activated or deactivated. It can be configured to send these CDRs to a remote system to be collected and analyzed. There is no provision for records to be stored on a long-term basis on the Meeting Server, nor any way to browse CDRs on the Meeting Server.

The Meeting Server supports up to four CDR receivers, enabling you to deploy different management tools such as Meeting Management, or more than one instance of Meeting Management for resiliency.

For more information on setting up Meeting Management as a CDR receiver, see the [Cisco Meeting Management Admin Guide](#).

You can use either the Web Admin Interface or the API to configure the Meeting Server with the URI of the CDR receivers. If you are using the Web Admin interface go to **Configuration > CDR settings** and enter the URI of the CDR receivers. Refer to the [Call Detail Records Guide](#) or the [API Reference guide](#) for details on using the API to configure the Meeting Server with the URIs of the CDR receivers.

3.1.7 Host name

Cisco recommends that the Meeting Server is given its own hostname.

1. If necessary, SSH into the MMP and log in.

2. Type:

```
hostname <name>
hostname london1
hostname mybox.example.com
```

3. Type:

```
reboot
```

Note: A reboot is required after issuing this command.

3.1.8 Other requirements

- Access to an LDAP server to import users. This can be a Microsoft Active Directory (AD) server or an OpenLDAP server.

If you plan for users to utilise the web apps to connect to the Meeting Server, then you must have an LDAP server. User accounts are imported from the LDAP server. You can create user names by importing fields from LDAP as described in [LDAP configuration](#). The passwords are not cached on the Meeting Server, they are managed centrally and securely on the LDAP server. When a web app authenticates, a call is made to the LDAP server.

- Decision on a dial plan to use to reach calls hosted on the Call Bridge. The dial plan will depend on your environment; that is whether you are making one or more of the following types of call: Lync, SIP (including voice) or web app calls. Instructions for deploying this dial plan are given in [Chapter](#).
- Access to one or more of the following to test the solution: Lync clients, SIP endpoints, SIP phones and/or web apps as appropriate.
- Access to a SIP Call Control platform if you intend to make SIP calls. [Chapter 7](#) and [Chapter](#) explain how to set up a SIP trunk to the Cisco VCS and summarizes the required dial plan configuration changes. Information on setting up the SIP Trunk to a Cisco Unified Communications Manager (CUCM), the Avaya CM and Polycom DMA is provided in the [Cisco Meeting Server Deployments with Call Control](#) guide; you can use other call control devices not listed in the guide.
- If you intend to integrate the Meeting Server with an audio deployment, the Meeting Server must connect to a Voice Call Control device attached to a PBX; it is not possible to connect a Meeting Server directly to a PBX.
- If deploying in a Lync environment, access to the Lync Front End (FE) server to make dial plan configuration changes there. The changes required are given in this document.

3.1.9 Specific prerequisites for a virtualized deployment

- A host server that complies with the resources specified in the [Installation Guide for Cisco Meeting Server Virtualized Deployments](#).

3.2 Meeting Server Edge hardware configuration

The Meeting Server Edge role can be deployed as a single server or as multiple servers. The choice is driven by the concurrent call capacity needed for external web app participants. If a high percentage of your participants are expected to be external web app participants, Cisco recommends deploying Edge servers so their capacity matches or exceeds the Call Bridge capacity in the core. Note that excess Edge capacity will not enable more participants to connect than what the core Call Bridge deployment supports. Edge provides the Web Bridge

and TURN capacity for a participant; the core must still provide the Call Bridge capacity for the web app participant.

3.2.1 Edge server configurations

Two virtual machine hardware configurations are supported for the Edge server role. These configurations define the supported minimum hardware requirements and capacities they support.

"Small" Edge Server

1 x Cisco Meeting Server VM with the following specification for supported Cisco hardware

- 4 GB RAM
- 4 vCPUs
- 1Gbps network interface

"Large" Edge Server

1 x Cisco Meeting Server VM with the following specification for supported Cisco hardware

- 8 GB RAM
- 16 vCPUs
- 10Gbps network interface

Recommended processor specifications:

We recommend processor specification such as Intel Xeon E5 2600 running at 2.5GHz or higher. We recommend 1 vCPU to 1 physical CPU.

NIC requirement:

Cisco has tested and validated Split-server deployment using single NIC configuration for the TURN Servers. Hence, from version 3.0, we recommend you configure listening ports for a TURN Server only on one interface.

Co-residency support:

The Edge server can be co-resident with other VMs. However, each 4 vCPU VM has a 1 Gbps NIC requirement and each 16 vCPU has a 10Gbps NIC requirement. The VM host will need sufficient NIC capacity for all applications.

Note:

- Meeting Server 1000 M4 hardware supports 1Gbps NIC. Meeting Server M5 onwards hardware supports 10Gbps NIC.
 - The CMS 2000 is not suitable as a Meeting Server Edge instance.
-

Table 5: Edge Server web app call capacities

Type of calls	Small Edge VM Call Capacity	Large Edge VM Call Capacity
Full HD calls 1080p30 video	100	350
HD calls 720p30 video	175	700
SD calls 448p30 video	250	1000
Audio calls (G.711)	850	3000

The two Edge server configurations provide capacities that simplify matching Edge capacity to Core Call Bridge capacity when using Cisco Meeting Server appliances for Call Bridge.

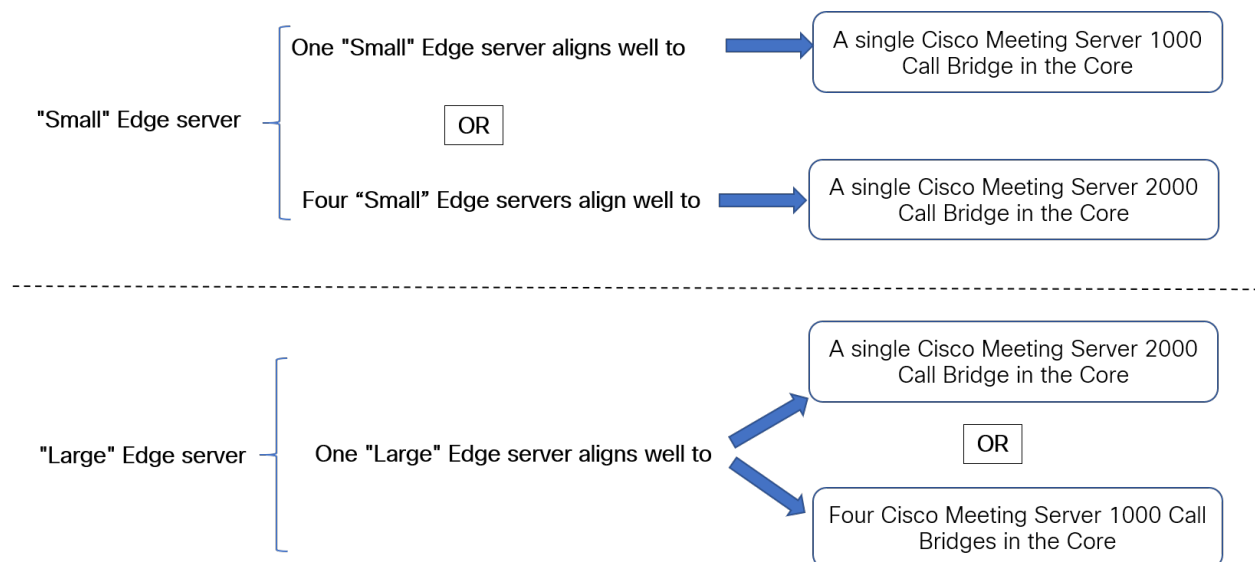

Determine the number of Edge servers needed by reviewing the Call Bridge call capacity the core Call Bridge supports, and the Edge server hardware configuration being used.

3.2.2 Deployment considerations

- We recommend that all edge servers serving the same Call Bridge or Call Bridge Group be the same capacity, i.e. all 4 vCPUs or all 16 vCPUs, not a mix of both.
- For scalable or resilient deployments, we recommend that you configure Call Bridge groups. This allows you to assign a unique group of TURN servers to each Call Bridge group which is useful for helping with load balancing and keeping TURN servers sensibly geolocated with Call Bridges.

- For web app to match SIP scale (up to 24 Call Bridges per cluster), we support multiple edge servers. However, Call Bridge groups only support up to 10 Edge servers per group. For scalable or resilient deployments needing more than 10 Edge servers, more than one Call Bridge group will be necessary.
- To support the Meeting Server Edge solution, a new MMP command **turn highcapacity-mode (enable|disable)** is introduced that enables TURN scalability mode. This setting is enabled by default.

3.3 Network Planning for Meeting Server Edge

3.3.1 Technical description

The Meeting Server Edge design requires you deploy Edge instances where they are reachable by external participants. This can be in your DMZ or public networks. The recommended deployment is for an Edge instance to be deployed in the DMZ behind a NAT or firewall with selective rules allowing only required traffic. The Edge server in the DMZ must be reachable by the Call Bridge servers deployed in the core. We recommend the DMZ/Intranet boundary be access controlled with only required traffic being allowed.

Web app client connectivity is achieved by having the Call Bridge connect outbound to the Web Bridge C2W interface using TLS to establish a control channel between the core and edge for Web Bridge functions. External clients connect to the Web Bridge listening port using HTTPS.

Media traffic for external web app clients is handled using the TURN Server as a relay. Authenticated web clients connect to the TURN Server's listening port and request a relay transport address be allocated for them on the TURN Server's interface. Using ICE, the client and Call Bridge validate they can send traffic through this relay to each other and if it is their best route. The Call Bridge can send media outbound to the allocated relay address, which is sent onward (or 'relayed') to the external client by the TURN Server. Traffic from the client is sent to the TURN Server listening address and relayed using the relay transport address as its source, back to the Call Bridge. The UDP based media can reach the Call Bridge in the core by the firewall allowing symmetric UDP traffic back to the originating connection.

Note: From version 3.0, we recommend you configure the listening ports for a TURN Server on a single interface.

Using a TURN relay setup by the external client is the required deployment model for the Edge server to achieve the published call capacities. Other combinations or scenarios may result in media connectivity being established but can result in reduced capacities and suboptimal media routing and therefore are not advised.

The recommended deployment for Meeting Server Edge enables external web app participants to connect to the Edge instance using TURN over UDP and the Call Bridge connecting to the TURN relay via UDP. This configuration is optimal for balancing security and

performance. To improve compatibility with restrictive client networks, an optional scenario to add a second DMZ interface to move TURN to its own interface to support TURN over TCP 443 is also covered. While other combinations of network paths and service configurations are technically feasible, they are not documented by Cisco as they may incur other security risks, capacity impacts, or are simply excluded from this guide to reduce variations.

Figure 8: Sample Diagram of TURN using UDP

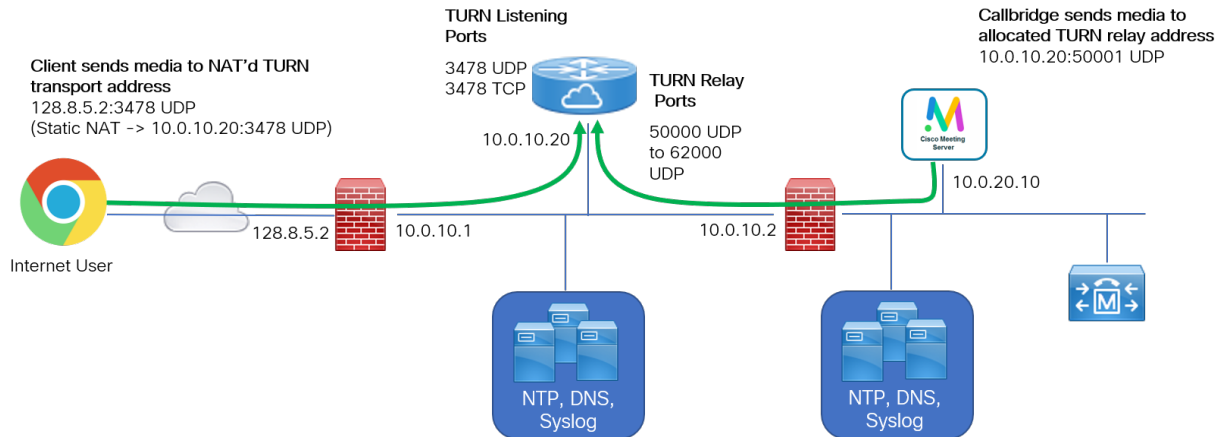

3.3.2 Network planning

This section outlines the network requirements to operate Meeting Server Edge instances in a DMZ network. The nomenclature used assumes there are three security levels of network. The Internet, a DMZ, and an Intranet. The scenarios outlined include multiple meeting server instances and TCP fallback. Destinations are labeled based on their role and may map to multiple addresses in your environment.

3.3.2.1 DMZ to Internet boundary

The DMZ by default should only accept incoming connections from the Internet for approved traffic and services. Because we do not know where participants may connect from, connections to these services must be accepted from all source IPs.

Note: The DMZ network maybe NAT'd or directly routable from the public internet. The examples here assume the DMZ is NAT'd.

To support web app, the firewall must accept incoming TCP connections from the Internet to port 443 for the Meeting Server Edge servers hosting the Web Bridge 3 service. Optionally you can enable TCP port 80 if you wish to enable HTTP redirect so users who attempt a HTTP connection will automatically redirect to HTTPS. Participants are not allowed to use HTTP for calls; the port only supports redirecting to HTTPS.

Media is best sent over UDP but call participants on the internet may find themselves behind firewalls which could block UDP traffic, so an optional TCP fallback is offered. For media traffic, the firewall should accept incoming connections to the Edge Server on TURN listening port UDP 3478. When enabling TURN using TCP, TURN server listens also listens on TCP 3478 and the designated port. If enabling TURN using TCP 443, a second DMZ IP interface is needed on the server with TURN and Web Bridge 3 each listening on different interfaces.

Note: If the DMZ is NAT'd and you are using multiple Edge Servers, separate IPs are needed in the NAT configuration for each Edge server because each must be directly addressable from the Intranet for UDP traffic.

3.3.2.2 DMZ to Internet traffic rules

Description	Direction	Source IP	Source Protocol: Port	Target IP	Target Protocol: Port
Client Browser HTTPS	INCOMING	Any	TCP {unreserved}	{WB3}	TCP 443
Client Browser (Optional)	INCOMING	Any	TCP {unreserved}	{WB3}	TCP 80
Client STUN/TURN	INCOMING	Any	UDP {unreserved}	{TURN}	UDP 3478
Client STUN/TURN TCP	INCOMING	Any	TCP {unreserved}	{TURN}	TCP 3478
Client STUN/TURN TCP 443 (Optional)	INCOMING	Any	TCP {unreserved}	{TURN}	TCP 443
Symmetric return TURN traffic (usually automatic)	OUTGOING	{TURN}	UDP {3478}	Any	UDP {unreserved}

Note:

- {WB3} = IP list of Web Bridge 3 server listening interfaces
- {TURN} = IP list of TURN server listening interfaces
- TURN TCP 443 is an optional deployment. If you want to enable TURN TCP on 443 and you are already using TCP port 443 for Web Bridge 3, regardless of whether they are on separate interfaces, you must deploy a new Meeting Server Edge server.

- Firewall must allow symmetric or return UDP traffic to the Internet for media from TURN Server relay
- Each TURN Server must be independently addressable from the Internet when using multiple TURN servers

3.3.2.3 Intranet to DMZ boundary

By default, the firewall should not permit any TCP connections to be made from the Meeting Server Edge server instance towards the intranet to protect the intranet. It must also not allow any UDP packets to be sent from the Meeting Server Edge server into the intranet, unless a UDP packet has already (and recently) been sent from the intranet to the edge box on the same address/port pairing i.e. a UDP packet from <DMZ IP>:50342 to <Intranet IP>:50131 should be blocked unless there was previously a packet from <Intranet IP>:50131 to <DMZ IP>:50342.

The firewall must allow incoming TCP connections to the Meeting Server Edge server on the C2W listening port from the Call Bridges operating in the core. It should also permit inbound UDP packets from the call bridges operating in the core (i.e. source <any core callbridge IP>: <32,768 to 65,535 > to destination <Edge CMS IP>: <50,000 to 62,000 >). The firewall must allow the return UDP traffic for these connections.

Having the core Call Bridges directly routable with the Meeting Server Edge nodes is preferred, but the core Meeting Servers can be behind a NAT relative to the DMZ services and still use the TURN relay allocated by external clients. The core Meeting Servers do not need to connect to the TURN listening ports as the relay setup by the external client is sufficient for both parties. If using NAT, traffic to the call bridge will be seen as a peer-reflexive candidate in the ICE connection testing.

Description	Direction	Source IP	Source Protocol: Port	Target IP	Target Protocol: Port
Meeting Server C2W Interface	OUTGOING	{Call Bridge IPs}	TCP {unreserved}	{WB3}	Web Bridge 3 C2W listening port. Eg., webbridge3 c2w listen a:9999 would use TCP 9999
Call Bridge Media Traffic	OUTGOING	{Call Bridge IPs}	UDP {32,768 to 65,535}	{TURN}	UDP {50,000 to 62,000}
Symmetric return TURN traffic (usually automatic)	INCOMING	{TURN}	UDP {50,000 to 62,000}	{Call Bridge IPs}	UDP {32,768 to 65,535}

Note:

- {WB3} = IP list of Web Bridge 3 servers
- {TURN} = IP list of TURN servers
- Call Bridge = IP list of the Call Bridge servers in the core
- Firewall must allow symmetric/return UDP traffic to the Internet for media from TURN Server relay
- You must configure the listening ports for a TURN Server on a single interface.

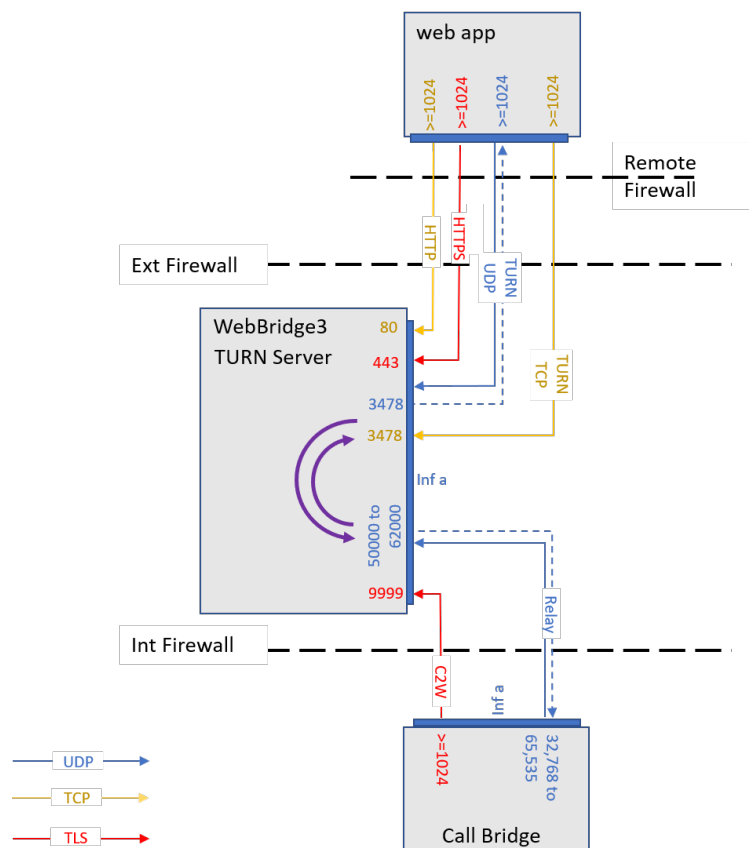
Figure 9: web app using TURN 3478 UDP or 3478 TCP**3.3.2.4 Management and Platform Traffic**

For clarity purposes, the prior network requirement sections excluded discussing requirements for management services and platform needs. Management and Platform requirements are covered separately in this section. Because infrastructure services and administrative management policies for DMZ networks will vary between organizations, these topics will be described in terms relative to the Edge Meeting Server instance, rather than describing which network boundary they cross. Apply these concepts to the specifics of your environment.

For the Meeting Server to handle TLS and certificates properly the Edge server must be able to access NTP and DNS services. Administrators will also need to use SFTP and SSH to configure and update the Meeting Server software. Syslog for centralized logging is optional, but strongly recommended. These services should be configured to be accessible from the Edge's DMZ network interface while adhering to common security practices such as restricting traffic to known sources.

3.3.2.5 Management Traffic for Meeting Server Edge

Description	Direction	Source IP	Source Proto:Port	Target IP	Target Proto:Port
NTP	OUTGOING	{WB3} or {TURN}	UDP 123	{NTP Server}	UDP 123
DNS	OUTGOING	{WB3} or {TURN}	UDP {unreserved}	{DNS Server}	UDP 53
Syslog	INCOMING	{WB3} or {TURN}	TCP {unreserved}	{Syslog Server}	TCP 514*
App Management (SSH, SFTP)	INCOMING	{Intranet/Admin IPs}	TCP {unreserved}	{WB3} or {TURN}	TCP 22

Note:

- {WB3} = IP list of Web Bridge 3 servers
- {TURN} = IP list of TURN servers
- Syslog destination port is configurable
- Verification of certificates may require outbound connections to OSCP or CRL destinations as defined by the certificates in use
- Not documented here are other server management technologies that maybe used to manage the server hardware or hypervisor used to host the Meeting Server virtual machine (ESXi, Cisco CIMC interface, etc).

3.3.3 Deploying Meeting Server web edge

The following steps give a high level view of how to deploy Meeting Server web edge:

1. Configure the TURN server on the Meeting Server edge via the MMP.
2. Configure Web Bridge 3 on the Meeting Server edge via the MMP.
3. Link the Web Bridge 3 to the Call Bridge, (i.e. add the **callBridge** parameter via the Web Admin user interface under **Configuration > API to /api/v1/turnServers** and **/api/v1/webBridges**, and check Web Bridge 3 certificate requirements).

4. Check that connections are functioning correctly – to do this, you can test manually by logging in via the web app address, or check on the Web Admin interface under **Status > General** and look at the **Fault conditions**, and **Recent errors and warnings**. (Note that Web Bridge 3/TURN connection failure messages aren't shown.)
5. Add the firewall settings as follows:
 - a. Call Bridge must be able to connect to the TCP connection Web Bridge 3 c2w connection ports (as specified on the "c2w://address:port" in the API; i.e. in the **url** field on **/api/v1/webBridges**.)
 - b. TURN relay ports on the Meeting Server edge are 50000 to 62000, so Call Bridge must be able to contact those on UDP to send media.
 - c. External web app clients must be able to reach the TURN Server on UDP 3478. A fallback to TCP is possible, the port depends on the 'turn tls <port>' configuration so that port would also need to be opened on that occasion.

4 Configuring the MMP

The Meeting Server components are configured using the MMP. Each Meeting Server instance will need configuration.

4.1 Creating and managing MMP and Web Admin interface user accounts

You should have created an MMP administrator user account by following the [Cisco Meeting Server Installation Guide](#); if so, go on to the next section. The same account is used to access the Web Admin Interface.

(If you do not have these MMP administrator user accounts, you will have to use the emergency admin recovery procedure detailed in the [Installation Guide](#) appropriate to your deployment.)

Note: See the [MMP Command Reference Guide](#) for the full range of MMP commands, including setting up additional administrator user accounts and user accounts with other roles.

4.2 Upgrading software

The Cisco Meeting Server 2000, and Cisco Meeting Server 1000 ship with the latest software release available at the time of shipment, but may not be up-to-date. Equally, if you downloaded the software some days ago, we advise you to check on the Cisco website in case a later version is available, and if so, upgrade to the latest version.

The following instructions apply to all types of deployment:

1. To find out which software version is running on the Meeting Server, SSH into the MMP of the server, log in and type:
version
2. Before upgrading your Meeting Server:
 - a. take a backup of the current configuration on the server . Save the backup safely to a local server. See the [MMP Command Reference guide](#) for full details. Do NOT use the automatic backup file that is created during the upgrade process.
 - b. save the cms.lic and certificate files to the local server.
 - c. using the Web Admin interface, check that all calls (SIP and clients) are working and no fault conditions are listed.
 - d. If your deployment has clustered database, uncluster the nodes using the **database cluster remove** command.

3. To upgrade, first download the appropriate software file from the Cisco website. Click on this [link](#), then click on the appropriate Meeting Server type listed in the right hand column of the web page and follow any instructions displayed with the download link.
4. Use an SFTP client to upload the new software image to the MMP of the Meeting Server. For example:

```
sftp admin@10.1.124.10
put upgrade.img
```

where 10.1.x.y is an IP address or domain name.

5. To upgrade the server, connect via SSH to the MMP and type:

```
upgrade
```

 wait approximately 10 to 12 minutes for the server to restart, and for the Web Admin interface to be available.
6. To verify that the upgrade was successful, SSH into the MMP, log in and type the following command:

```
version
```

This completes the upgrading of the Meeting Server deployment. Now verify that:

- dial plans are intact,
- and no fault conditions are reported on the Web Admin interface and log files.

Check that you are able to connect using SIP and web app (as well as Web Bridge 3 if that is supported).

Note on rollback procedure: If anything unexpected happens after you upgrade the server and you decide to downgrade, simply upload the software release for the previous version, and type `upgrade`. Then use the MMP command `factory_reset app` on the server. Once the server has rebooted from a factory reset, use the `backup rollback <name>` command to restore the backup configuration files on the server. Providing you restore the backup file that was created from the server, the license file and certificate files will match the server.

4.3 Configuring the Call Bridge

The Call Bridge service should run on the main Meeting Server instance in your internal network. The Call Bridge needs a key and certificate pair that is used to establish TLS connections with SIP Proxies, peers like the Skype Front End (FE) server and for C2W connections for Web Bridge. If your peer SIP Proxy requires TLS (Example: Skype for Business) the certificate must be trusted by the peer.

Note: SIP and Skype calls can traverse local firewalls using the Cisco Expressway, you will need to configure trust between the Call Bridge and the Cisco Expressway. Cisco Expressway must be running X8.9 or later. For more information, see [Cisco Expressway Options with Cisco Meeting Server and/or Microsoft Infrastructure \(Expressway X8.9.2\)](#) or if running X8.10 see [Cisco Expressway Web Proxy for Cisco Meeting Server \(X8.10\)](#) and [Cisco Expressway Session Classification Deployment Guide \(X8.10\)](#).

The command `callbridge listen <interface>` allows you to configure a listening interface. The default recommendation is to enable Call Bridge to listen on the first interface 'a'

1. Create and upload the Call Bridge certificate and keys as described in the [Certificate Guidelines](#).
2. Sign into the MMP and configure the Call Bridge to listen on interface a.

```
callbridge listen a
```

Note: The Call Bridge must not have a NAT between it and SIP participants or SIP Proxies it needs to directly communicate with. Call Bridge can be paired with firewall traversal solutions like Cisco Expressway to address Firewall Traversal or NAT issues, but must not traversal a NAT between it and the SIP Proxy.

3. Configure the certificates Call Bridge will use with the command:

```
callbridge certs <key file> <certificate file> <ca bundle>
```

Example:

```
callbridge certs callbridge.key callbridge.crt ca-bundle.crt
```

More information regarding certificates and using a certificate bundle as provided by your CA, is described in the [Certificate Guidelines](#).

4. Restart the Call Bridge interface to apply the changes.

```
callbridge restart
```

4.4 Configuring the Web Admin interface for HTTPS access

The Web Admin interface is needed on your Meeting Server instance where Call Bridge is running but is not required for the Meeting Server instances in the Edge. For reduced attack surface, the recommendation is to not run Web Admin on Edge instances.

The Web Admin Interface is the Call Bridge's user interface. You should have set up the certificate for the Web Admin Interface (by following one of the Installation Guides). If you have not, do so now.

1. The installation automatically set up the Web Admin Interface to use port 443 on interface A. However, the Web Bridge also uses TCP port 443. If both the Web Admin Interface and

the Web Bridge use the same interface, then you need to change the port for the Web Admin Interface to a non-standard port such as 445, use the MMP command `webadmin listen <interface> <port>`. For example:

```
webadmin listen a 445
```

2. To test that you can access the Web Admin Interface, type your equivalent into your web browser: <https://meetingserver.example.com:445>

If it works, proceed to the next section.

3. If you cannot reach the Web Admin Interface:
 - a. Sign into the MMP, type the following and look at the output:

```
webadmin
```

The last line of the output should say "`webadmin running`".

- b. If it does not there is a configuration problem with your Web Admin Interface. Check that you have enabled it by typing:

```
webadmin enable
```

- c. The output of the `webadmin` command should also tell you the names of the certificates you have installed, e.g. `webadmin.key` and `webadmin.crt`.

Note: They should be the same names of the certificates you uploaded previously.

Assuming these are the names then type:

```
pki match webadmin.key webadmin.crt
```

This will check that the key and certificate match.

- d. If you are still experiencing issues, troubleshoot the problem as explained in the [Certificates Guidelines](#).

4.5 Stage Edge Server instances

Complete this section if you will be using Meeting Server as the Edge for external web app participants. If you are not supporting web app clients that cannot directly access the Call Bridge, you do not need Meeting Server Edge and may skip this section.

Meeting Server Edge instances should only be configured with the minimum services necessary to keep its security exposure as minimal as possible. To perform their role, Edge Server instances only need the Web Bridge 3 Service and TURN Services enabled. The server will also need NTP and DNS clients configured so it can do lookups and maintain accurate time required for TLS operations. While optional, configuring syslog to send logs to a central server is recommended. The deployment steps will cover both the standard TURN UDP configuration, and the optional TURN configuration using TCP 443.

Before configuring Web Bridge and TURN, any Meeting Server instances in the Edge should be deployed per the Installation Guide relevant to your platform and have completed:

- Setup access to the server MMP interface (console or SSH)
- Configuring the IP information for the network interface(s)
- Configured the DNS client on the server
- Configured the NTP client on the server
- Configured Syslog if desired

For help with any of these tasks, please refer to the Installation Guides and MMP Command reference.

4.6 Configuring Web Bridge 3

Web Bridge 3 is used to enable the use of the browser based Cisco Meeting Server web app. If you are not enabling use of the web app in your deployment, you do not need the Web Bridge Service and can skip this section.

- If you need to support web app clients from your internal network, you should configure Web Bridge on your main Meeting Server instance in the Core and complete the steps in this section.
- If you are using Cisco Expressway as your proxy and TURN Server for web app, Web Bridge needs to be configured on your main Meeting Server instance in the Core and you should complete the steps in this section.
- If you are using the Edge Meeting Server model, you have the option of running Web Bridge just in the Edge or running it both in the Edge and the main Internal Meeting Server instance. Enabling Web Bridge on the internal server allows clients to use web app without making connections to the Web Bridge in the DMZ. The recommendation for deployments using the Edge Meeting Server model is to run Web Bridge in both the DMZ and internal server instances. Complete the steps in this section and configure Web Bridge on the Edge instances and the main Meeting Server instance in the Core.

Note: Running Web Bridge in both the Core and Edge requires clients resolve the same Web Bridge hostname to either the internal or Edge instance as appropriate for them - this is normally referred to as 'Split-DNS' where the DNS Server resolves names to addresses based on where the client is located.

CAUTION: Important notes for Expressway users

If you are deploying Web Bridge 3 and web app you must use Expressway version X14.3 or later, earlier Expressway versions are not supported by Web Bridge 3.

Note: For more information on the web app, see [Cisco Meeting Server web app Important Information](#).

4.6.1 Useful information to help configure Web Bridge 3

The following is useful information to help you configure Web Bridge 3 so that you can use web app:

- "Call Bridge to Web Bridge" protocol (C2W) is the link between the callbridge and webbridge3. It is an outgoing connection from the Call Bridge to the Web Bridge to establish a control channel between them. Certificates are used to authenticate and secure the C2W connection. C2W is exclusive to Call Bridge - Web Bridge traffic and is not used by users or other services.
- A C2W listening port is defined on the Web Bridge server (using `webbridge3 c2w listen`) to allow the Call Bridge to connect to the Web Bridge using an HTTPS connection. There is no set default value for the port number to use, but this guide uses 9999 as the example. This connection must be secured with certificates.
- We recommend you protect the C2W port from external access – it only needs to be reachable from Call Bridges.
- A Call Bridge must be able to uniquely reach the C2W interface of each Web Bridge it is configured to work with (C2W connections must use unique hostname or IP per Web Bridge 3 instance).
- Web app clients will have a single address to reach the Web Bridge so when multiple Web Bridges are used, DNS or Load Balancer solutions should be used to direct a shared name to an available Web Bridge instance. The client to Web Bridge connection is stateless for non-call activity and a session does not need to stay with a single Web Bridge.
- When establishing the TLS connection, both sides must present a certificate to verify. The Call Bridge uses the certificate set using the `callbridge certs` command and the Web Bridge uses the certificate set using the `webbridge3 c2w certs` command.
- The Web Bridge will trust certificates of Call Bridges and Schedulers that are in the Web Bridge's C2W trust store or have been signed by a certificate in the trust store, set by `webbridge3 c2w trust`. It is recommended to use a bundle containing the Call Bridge certificates that will connect to this Web Bridge so that only specific certificate matches will be allowed (certificate-pinning).
- The Call Bridge will trust certificates of Web Bridges that are in the Call Bridge's C2W trust store or have been signed by a certificate in the trust store, set by `callbridge trust c2w`. It's recommended to use a bundle containing the Web Bridge certificates that this Call Bridge will connect so that only specific certificate matches will be allowed (certificate-pinning).

- The Scheduler trusts certificates of Web Bridges that are in the Scheduler's C2W trust store or have been signed by a certificate in the trust store, set by the command `scheduler c2w certs <key-file> <crt-fullchain-file>`.
- If the certificates used for C2W or Call Bridge have extended key usages defined, they must have the usages enabled to allow a Mutual TLS authentication exchange between Call Bridge and Web Bridge. If extended key usages are defined in a certificate, the Web Bridge 3 C2W certificate must include the "server authentication" extended key usage, and the Call Bridge certificate must include "client authentication" extended key usage. If no extended key usages are defined in a certificate, all usages are assumed valid.
- As the C2W connection is only between internal services, you do not explicitly need to use a certificate signed by a public authority. You can use self-signed certificates created within the MMP.
- The SAN/CN in the Web Bridge C2W certificate must match the FQDN or IP address that is used in the `c2w://` url used to register the Web Bridge 3 in the Call Bridge API. If this does not match, the Call Bridge will fail the TLS negotiation, rejecting the certificate presented by the Web Bridge, and will fail to connect with the Web Bridge.

Note: If you want a certificate signed by a Public CA you will need to use the FQDN. (Certificates containing an IP address cannot be signed by a Public CA.) If you want to use an IP address in the C2W address you can create your own certificates as the C2W connection is not a public connection, therefore using Public CAs is not necessary.

- The certificate used for the Web Bridge listening interface should be signed by a certificate authority the clients will trust to avoid certificate warnings when clients connect. The FQDN the clients use to reach Web Bridge should be in the certificate CN or SAN list to avoid certificate warnings when clients connect.
- For general certificate information, see the [Certificate Guidelines](#) appropriate for your deployment.

4.6.2 Enabling the Web Bridge 3 Service

The Web Bridge service should be enabled on the Core Meeting Server instance if using the Cisco Expressway proxy or supporting web app clients who can reach the Call Bridge directly. When using the Meeting Server Edge deployment, Web Bridge 3 should run on all Edge instances and can optionally be ran on the Core Meeting Server instance where Call Bridge is running.

Complete these steps on each Meeting Server instance where Web Bridge 3 will run.

1. SSH into the MMP and log in.
2. Configure the interface and port web bridge will use for the web server with the command `webbridge3 https listen <interface>:<port>`.

Using the first interface and port 443 is recommended. Example:

```
webbridge3 https listen a:443
```

3. Set the HTTPS certificate and key pair Web Bridge will use for its web server with the command `webbridge3 https certs <key file> <full certificate chain file>`.

This command requires the certificate be defined as the full certificate chain - meaning a certificate bundle that starts with the end entity certificate, includes all the intermediate signing certificate authorities, and ends with the root certificate. Example:

```
webbridge3 https certs wb3-https.key wb3-https-fullchain.crt
```

4. Configure the interface and port for the C2W connection with the command

```
webbridge3 c2w listen <interface>:<port> .
```

Using the first interface and the default example port 9999 is recommended. Example:

```
webbridge3 c2w listen a:9999
```

5. Configure the C2W connection certificates with the command `webbridge3 c2w certs <key file> <full certificate chain file>`.

Example:

```
webbridge3 c2w certs wb3-c2w.key wb3-c2w-fullchain.crt
```

Note: This certificate must include the FQDN or IP address of the C2W interface in the CN or SAN list of the certificate. Additional information is also available in this FAQ - [How do I configure connection certificates for use with Web Bridge 3?](#)

6. The Web Bridge 3 C2W trust store must be configured to control which Call Bridge will be allowed to connect to this Web Bridge. The trust bundle should include the Call Bridge certificate of all Call Bridges that will connect to this Web Bridge, or the certificate of the CA that signed the Call Bridge certificates. For the most control, it is recommended to use the individual Call Bridge certificates in the bundle (certificate-pinning) rather than the certificate of the signing authority. Configure the web bridge's c2w trust bundle with the command `webbridge3 c2w trust <certificate bundle>` Example:

```
webbridge3 c2w trust wb3-c2w-trust-bundle.crt
```

7. Enable the http redirect. This is optional, but recommended for end-user ease of use

```
webbridge3 http-redirect enable
```

8. Enable the web bridge service

```
webbridge3 enable
```

Repeat the above steps for each Meeting Server instance where Web Bridge will be running and ensure the certificate or key pairs used are correct for each instance.

4.6.3 Configuring Call bridge C2W connections

C2W is the control interface between the Call Bridge and Web Bridge instances and must be configured in the Call Bridge if Web Bridge is deployed. The Call Bridge's C2W trust bundle should include the Web Bridge C2W certificates of all Web Bridge that this Call Bridge will connect to, or the certificate that signed the Web Bridge C2W certificates. For the most control, it is recommended to use the individual Web Bridge C2W certificates in the bundle (certificate-pinning) rather than the certificate of the signing authority.

1. Connect to the MMP interface of the Internal Meeting Server running Call Bridge.
2. The Call Bridge should already be configured with a certificate from the steps performed in [Configuring the Call Bridge listening interface](#). Confirm by running the command `callbridge` and checking that the Key File and Certificate file settings are configured. If not, repeat the steps in [Configuring the Call Bridge listening interface](#) before proceeding. The Call Bridge must be configured with certificates for C2W functionality.
3. Use the command `callbridge trust c2w <certificate bundle file>` to configure the Call Bridge's C2W trust store with a certificate bundle that includes the C2W certificates of the Web Bridge instances. Example:

```
callbridge trust c2w c2w-callbrige-trust-store.crt
```

Note: Unless limited by scopes, the Call Bridge will attempt to connect to all Web Bridge that are defined in the Meeting Server API.

4. Restart the Call Bridge

```
callbridge restart
```

4.6.4 Configure Call Bridge with Web Bridge Addresses

The Call Bridge must be told the C2W address of each Web Bridge it will connect to (including a co-resident Web Bridge) by creating a Web Bridge entry in the Meeting Server API. This guide will use API explorer in the Web Admin interface of Meeting Server to illustrate how to complete this task.

1. Log in to the Meeting Server Web Admin interface and select **Configuration > API**.
2. Using the Filter input box, type `webBridges` to filter the list view, as shown here:

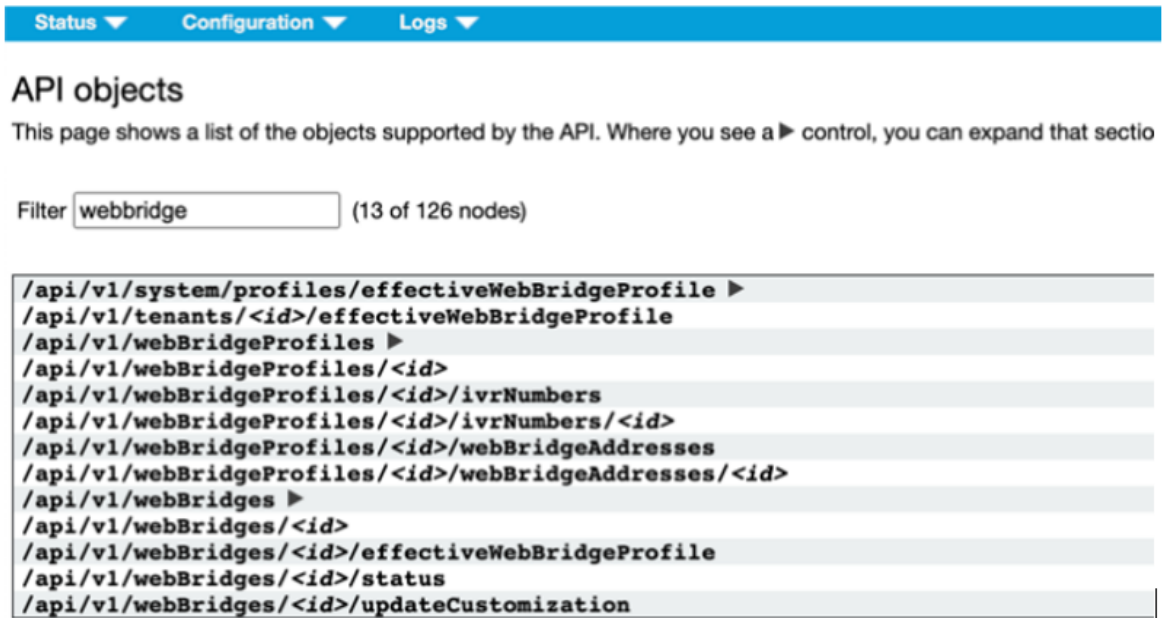

3. Locate the `/api/v1/webBridges` row from the resulting list and click the ► icon to expand it.
4. Click **Create new** to create a new Web Bridge object and the following parameter fields display as shown here:

The screenshot shows the 'Create new' form for a Web Bridge object in the Meeting Server Web Admin interface. At the top, there are navigation tabs for 'Status', 'Configuration', and 'Logs'. Below the tabs, there is a button labeled '« return to object list'. The form title is '/api/v1/webBridges'. The form contains several input fields, each with a checkbox and a 'Choose' button: 'url' (with '(URL)' next to it), 'tenant', 'tenantGroup', 'callBridge', 'callBridgeGroup', and 'webBridgeProfile'. At the bottom of the form, there is a 'Create' button.

5. Fill in the `url` field using the format `c2w://<Web Bridge FQDN>:<c2w port>` with the FQDN address of the C2W interface for Web Bridge being added. Example:

`c2w://cmsedge1.company.com:9999`

Note: The FQDN entered here must be the CN or in the list of SAN names of the certificate assigned to the C2W interface of Web Bridge 3 and must resolve to the IP of the C2W interface for the Web Bridge. IP Addresses can only be used if the C2W certificate has the IP address in the certificate's SAN or CN.

6. Click **Create** to save the new Web Bridge entry.

If you have multiple Web Bridges, repeat the above steps creating one Web Bridge object for each Web Bridge instance.

4.7 Configuring the TURN Server

The TURN Server is used to provide media traversal services for web app users who cannot directly reach the Call Bridge.

- If you are not using the web app client in your deployment, you can skip this section.
- If you are using Cisco Expressway as your web proxy and TURN provider, please use the [Cisco Expressway Web Proxy for Cisco Meeting Server \(X14.3\)](#) for instructions on configuring the TURN Server and Call Bridge settings instead of this section.
- If you are using a Meeting Server Edge deployment, the TURN Server should be configured on each of your Edge instances. Complete the steps in this section to configure the TURN services.

Complete the following sections to configure a TURN Server and add it to Call Bridge.

4.7.1 Enable the TURN Service

1. SSH into the MMP and log in.
2. Enable the short term credential mode for TURN Server. Introduced in version 3.1, short term credentials offer a significant increase in security over the previously used static TURN Server credentials. The TURN credentials are used to control who can request a relay on the TURN Server and are automatically given to web app clients during call setup to allow use of the TURN Server. It is recommended that all deployments using Meeting Server Edge enable the short term credential mode. Enter the following command to enable short term credential mode:

```
turn short_term_credentials_mode enable
```

3. Set the shared secret and realm for the TURN Server's short term credential feature using the command:

```
turn short_term_credentials <shared secret> <realm>
```

These two values can be any string and should be treated like passwords. These values will also be needed when defining the TURN Server in the Call Bridge Settings. Example:

```
turn short_term_credentials mysharedsecret example.com
```

CAUTION: Your TURN Server password and credentials must be unique. Do not reuse your admin username or password.

4. If the TURN Server's listening interface is located behind a NAT relative to the Internet/external network, tell the TURN Server the public IP Address that maps to the TURN Server using the command:

```
turn public-ip <ip address>.
```

If your TURN Server uses a public routable IP address, skip this step. Example:

```
turn public-ip 5.10.20.99.
```

5. Configure the TURN Server to listen on a specific interface using the command `turn listen <interface allowed list>`. You should configure TURN to listen on the first interface 'a' along with Web Bridge. Example:

```
turn listen a
```

6. If enabling TURN TCP on 3478, configure the TCP port the TURN Server should use with the `turn tls <port|none>` command.

Example:

```
turn tls 3478
```

The example assumes you are using the TCP 3478 port. If you are not enabling TURN TCP, skip this step.

7. If enabling TURN TCP, the TURN Server must be configured with a certificate and key pair to use. The certificate should be signed by the same CA that signed the Web Bridge's certificate. If you are not enabling TURN TCP, you may skip this step. Configure the TURN Server's certificate with the command `turn certs <key file> <certificate file> <ca cert>`. Example:

```
turn certs turnCert.key turnCert.crt CABundle.crt
```

Note: The certificate used for TURN Server can be an existing certificate such as Web Bridge 3 certificate.

8. Enable the TURN Server

```
turn enable
```

If multiple Edge Server instances are to be used, repeat the above TURN configuration steps for each Edge Meeting Server instance ensuring the certificate/ key pairs used are correct for each instance.

4.7.2 Configure Call Bridge with TURN Addresses

The Call Bridge must be configured with the details of the available TURN Servers to use. These TURN configurations are only used for web app participants and Skype for Business call flows. See section [Dial plan configuration-integrating Lync/Skype for Business](#) for details on configuring Skype for Business support.

The Call Bridge must be told the TURN Server it can use by creating a **turnServers** entry for each TURN Server in the Meeting Server API. This guide will use API explorer in the Web Admin interface of Meeting Server to illustrate how to complete this task.

1. Log in to the Meeting Server Web Admin interface and select **Configuration > API**:
2. Using the Filter input box, type **turn** to filter the list view, as shown here:



3. Locate the `/api/v1/turnServers` row from the resulting list and click the ▶ icon to expand it
4. Click **Create new** to create a new **turnServer** object and the following parameter fields will be shown:

The screenshot shows the Cisco configuration page for `/api/v1/turnServers`. At the top, there is a navigation bar with 'Status', 'Configuration', and 'Logs' tabs. Below the navigation bar is a '« return to object list' button. The main content area is titled `/api/v1/turnServers` and contains a form with the following fields:

- `serverAddress`: checkbox and text input
- `clientAddress`: checkbox and text input
- `username`: checkbox and text input
- `password`: checkbox and text input
- `useShortTermCredentials`: checkbox and dropdown menu (currently set to '<unset>')
- `sharedSecret`: checkbox and text input
- `type`: checkbox and dropdown menu (currently set to '<unset>')
- `numRegistrations`: checkbox and text input
- `tcpPortNumberOverride`: checkbox and text input
- `callBridge`: checkbox and text input with a 'Choose' button
- `callBridgeGroup`: checkbox and text input with a 'Choose' button

A 'Create' button is located at the bottom of the form.

5. Fill in the following fields for the TURN Server being added:

serverAddress - Fill in the IP address or the DNS name of the TURN Server only if the Call Bridge has to connect TURN Server's listening port else provide a dummy address so the Call Bridge will not attempt to contact the TURN Server - Example: `nothing.local`

clientAddress - Fill in with the IP address or DNS name that external clients will use to reach the TURN Server

Note: If TURN is NAT'd, enter the public NAT address). For example: `128.8.5.2`

useShortTermCredentials - Set to **true** if you configured the TURN Server to use short term credentials in the prior section (recommended).

sharedSecret - Enter the `sharedSecret` string used when the TURN Server was configured in Step 3 of the previous section.

type - If this parameter is unset, it defaults to "standard", and tells the clients to use UDP 3478 and fallback on TCP 443 to connect to the TURN server. When deploying Meeting Server web edge, this parameter should be set to "cms".

tcpPortNumberOverride - If you configured TURN TCP on a port other than 443, enter the port number configured with the `turn tls` command.

Note: Using this configuration can generate a status that the Call Bridge cannot connect to the TURN Server due to the dummy address in the `serverAddress` field. This is a known issue but does not impact the deployment.

6. Click **Create** to save the new TURN Server entry.

If you have multiple TURN Servers, repeat the above steps creating a TURN Server object for each TURN Server instance.

4.8 LDAP authentication for MMP users

The new **ldap** option is added to the **user add** MMP command enables you to configure details of an LDAP server, directory search parameters, TLS settings, and enable or disable LDAP authentication. During Meeting Server deployment, administrators and web app users with LDAP user accounts can log in to Web Admin Interface, SSH, SFTP, and serial console using LDAP authentication. User login will be rejected in case of failure in LDAP authentication.

Note: For Common access card (CAC) deployments, CAC authentication takes precedence over both, LDAP authentication and local authentication.

This feature does not support importing MMP users via LDAP, or converting existing local users to LDAP authenticated users. Administrator has to manually pre-configure the LDAP users by adding each user with the MMP command **user add**. Ensure that the login names are unique for local and LDAP users. To add LDAP users, a new option [**ldap**] is added to the command:

```
user add <username> (admin|crypto|audit|appadmin|api) [ldap]
```

Note: Meeting Server API does not support access to users with LDAP authentication.

The authentication of the users added using the **ldap** option is done by the LDAP server. No look up for local password is done in this case. In case of local users, authentication is done using a local password lookup only. LDAP authentication does not support password changes.

Note: In case the LDAP server becomes unavailable or Meeting Server is unable to reach the LDAP server, then LDAP users will be unable to log in. As a backup, it is a good practice to always keep at least one local admin user configured on the MMP.

Meeting Server supports configuration of a Microsoft AD LDAP server or an Open LDAP server, with either one of hostname/IPv4/IPv6, along with port, using the new **ldap** option. This LDAP server can be the same as the one used for web app user authentication. Make sure the LDAP server being used is a supported server type and it has to be configured separately for Meeting Server.

See the [MMP Command reference guide](#) for details.

5 LDAP configuration

If you plan for users to utilize the web apps to connect to the Meeting Server, then you must have an LDAP server (currently Microsoft Active Directory, OpenLDAP or Oracle Internet Directory LDAP3, see note below). The Meeting Server imports the User accounts from the LDAP server.

You can create user names by importing fields from LDAP, as described in this section. The passwords are not cached on the Meeting Server, a call is made to the LDAP server when a web app authenticates, and therefore passwords are managed centrally and securely on the LDAP server.

Note: When configuring the Meeting Server for LDAP/AD sync, the fields which accept LDAP/AD attributes require that attributes are entered in their case-sensitive format. For example, if the username mapping uses the attribute `userPrincipalName` then `$userPrincipalName$` can result in successful sync but `$UserPrincipalName$` will result in sync failure. You are advised to check that each LDAP attribute is entered in the correct case.

Note: From version 2.1, the Meeting Server supports Oracle Internet Directory (LDAP version 3). This must be configured through the API, not the Web Admin interface. To configure the Meeting Server to support Oracle Internet Directory, the Meeting Server should not use the LDAP paged results control in search operations during LDAP sync. POST to `/ldapServers` or PUT to `/ldapServers/<ldap server id>` the request parameter `usePagedResults` set to false.

5.1 Why use LDAP?

Using LDAP to configure the Meeting Server is a powerful and scalable way to set up your environment: defining your organization's calling requirements within the LDAP structure minimizes the amount of configuration required on the Meeting Server.

The server uses the concept of filters, rules and templates, which allow you to separate users into groups, for example:

- Everyone in the HR department
- Staff at grade 11 and above
- Job title = 'director'
- People whose surname starts with 'B'

5.2 Meeting Server settings

The examples in this section explain how to configure a single LDAP server (in this case Active Directory), using the Web Admin interface on the Meeting Server. However, the Meeting Server supports multiple LDAP servers which can be configured via the API, see the LDAP Methods section in the [API Reference guide](#).

When configuring a cluster of Call Bridges, the simplest method is to use the API. If configuring multiple Call Bridges via the Web Admin interface, each must have identical configuration.

Note: The Web Admin Interface only allows you to configure one LDAP server.

To set up the Meeting Server to work with Active Directory, follow these steps:

1. Sign in to the Web Admin Interface and go to **Configuration > Active Directory**.
2. Configure the connection to the LDAP server in the first section with the following:
 - Address = this is the hostname or IP address of your LDAP server
 - Port = usually 636
 - Username = the Distinguished Name (DN) of a registered user. You may want to create a user specifically for this purpose.
 - Password = the password for the user name you are using
 - Secure Connection = tick this box for a secure connection

For example:

```
Address: ldap.example.com
Port:    636
Username: cn=Fred Bloggs,cn=Users,OU=Sales,dc=YourCompany,dc=com
Password: password
```

Note: For further details of the permissions required by the user name and password credentials, see [Appendix F](#).

Note: The Meeting Server supports secure LDAP. By default the LDAP server runs on port 636 for secure communications and port 389 for insecure communications. The Meeting Server supports both, but we recommend using 636. Note that you must select Secure Connection (see above) for communications to be secure: using port 636 alone is not enough.

Note: When LDAP servers are configured with secure connection, connections are not fully secure until TLS certificate verification has been configured using the `tls ldap` command on the MMP.

3. Type the Import Settings which will be used to control which users will be imported.

- Base Distinguished Name = the node in the LDAP tree from which to import users. The following is a sensible choice for base DN to import users

```
cn=Users,dc=sales,dc=YourCompany,dc=com
```

- Filter = a filter expression that must be satisfied by the attribute values in a user's LDAP record. The syntax for the Filter field is described in rfc4515.

A rule for importing people into the main database might reasonably be 'import anyone with an email address', and this is expressed by the following filter:

```
mail=*
```

For testing purposes you may want to import a named user (e.g. fred.bloggs) and a group of test users whose mail address starts with "test"; for example:

```
( | (mail=fred.bloggs*) (mail=test*) )
```

If you wanted to import everyone apart from one named user (e.g. fred.bloggs), use this format:

```
( ! (mail=fred.bloggs*) )
```

To import users that belong to a specific group, you can filter on the memberOf attribute. For example:

```
memberOf=cn=apac,cn=Users,dc=Example,dc=com
```

This imports both groups and people that are members of the APAC group.

To restrict to people (and omit groups), use:

```
( & (memberOf=cn=apac,cn=Users,dc=Example,dc=com) (objectClass=person) )
```

Using an extensible matching rule (LDAP_MATCHING_RULE_IN_CHAIN / 1.2.840.113556.1.4.1941), it is possible to filter on membership of any group in a membership hierarchy (below the specified group); for example:

```
( & (memberOf:1.2.840.113556.1.4.1941:=cn=apac,cn=Users,dc=Example,dc=com) (objectClass=person) )
```

Other good examples which you can adapt to your LDAP setup include:

Filter that adds all Person and User except the ones defined with a !

```
( & (objectCategory=person) (objectClass=user) ( ! (cn=Administrator) ) ( ! (cn=Guest) ) ( ! (cn=krbtgt) ) )
```

Filter that adds same as above (minus krbtgt user) and only adds if they have a sAMAccountName

```
(&(objectCategory=person)(objectClass=user)(!(cn=Administrator))(!(cn=Guest))(sAMAccountName=*))
```

Filter that adds same as above (Including krbtgt user) and only adds if they have a sAMAccountName

```
(&(objectCategory=person)(objectClass=user)(!(cn=Administrator))(!(cn=Guest))(!(cn=krbtgt))(sAMAccountName=*))
```

This filter only imports specified users within (|(tree

```
(&(objectCategory=person)(objectClass=user)(|(cn=accountname)(cn=anotheraccountname)))
```

Global Catalog query to import only members of specified security group (signified with =cn=xxxxx

```
(&(memberOf:1.2.840.113556.1.4.1941:=cn=groupname,cn=Users,dc=example,dc=com)(objectClass=person))
```

4. Set up the Field Mapping Expressions

The field mapping expressions control how the field values in the Meeting Server's user records are constructed from those in the corresponding LDAP records. Currently, the following fields are populated in this way:

- Display Name
- User name
- space Name
- space URI user part (i.e. the URI minus the domain name)
- space Secondary URI user part (optional alternate URI for space)
- space call id (unique ID for space for use by WebRTC client guest calls)

Field mapping expressions can contain a mixture of literal text and LDAP field values, as follows:

```
$<LDAP field name>$
```

As an example, the expression

```
$sAMAccountName$@example.com
```

Generates:

```
fred@example.com
```

For more information see [More Information on LDAP Field Mappings.](#)

Note: Each imported user must have a unique user ID (JID), constructed using the JID field in the Field Mapping Expressions section of the **Configuration > Active Directory**. In order to construct a valid JID, any LDAP attribute used in the JID field mapping expression must be present in each LDAP record that is to be imported. To ensure that only records that have these attributes present are imported, we recommend that you include presence filters (i.e. those of the form (<attribute name>=*)) using a '&' (AND) in the Filter field under Import Settings for each attribute used in the JID field mapping expression.

For example, suppose your JID field mapping expression is `$sAMAccountName$@company.com`, and you wish to import users who are members of the group `cn=Sales,cn=Users,dc=company,dc=com`, an appropriate import filter would be:

```
( & (memberOf=cn=Sales , cn=Users , dc=company , dc=com) (sAMAccountName=*) )
```

5. To synchronize with Active Directory, select **Sync now** or activate the synchronization by using the appropriate API call (see the [Cisco Meeting Server API Reference Guide](#)).

Note: that you must manually resynchronize whenever entries in the LDAP server change.

6. View the result of the synchronization by going to **Status > Users**.

It is possible to choose whether to use OU separation when importing from the LDAP server. In the Web Admin Interface, go to **Configuration > Active Directory** and in the **Corporate Directory Settings** section select **Restrict Search to Searcher OU** to enable the search only within the OU of the user account.

5.3 Example

This example assigns a space to a particular group of users and a Call ID for this space using an 88 prefix in front of the regular telephone number.

1. Create the group in the LDAP structure called “space” and assign the required members to that group.
2. Use the following filter which uses the extensible matching rule (LDAP_MATCHING_RULE_IN_CHAIN / 1.2.840.113556.1.4.1941) to find all the users that are a member of the “space” group:

```
( & (memberOf:1.2.840.113556.1.4.1941:=cn=space , cn=Users , dc=lync , dc=example , dc=com) (objectClass=person) )
```

3. Then synchronizing a particular user in the directory called:

cn = Fred Blogs
TelephoneNumber = 7655
sAMAccountName = fred.blogs

creates the following space which can be viewed on the **Status > Users** page.

Name	Username
Fred Blogs	fred.blogs@example.com

And the following space that can be viewed on the **Configuration > space** page.

Name	URI user part
fred.blogs	fred.blogs.space

5.4 Enforcing passcode protection for non-member access to all user spaces

When spaces are auto-generated via an LDAP sync, they are all created without a passcode. By default `nonMemberAccess` is set to `true` so that the existing behavior remains unchanged, no passcode is required to access the space and non-members are able to access the created spaces.

Setting `nonMemberAccess` to `false` allows a company to enforce passcode protection for non-member access to all user spaces.

To ensure the member must configure non-member access and set a passcode as part of the LDAP sync:

- Either POST to `/ldapSources` or PUT to `/ldapSources/<ldap source id>` the request parameter `nonMemberAccess` set to `false`.
- To retrieve the `nonMemberAccess` setting, use GET on `/ldapSources/<ldap source id>`.

Note: Spaces created before version 2.4 (when this parameter was introduced) are unaffected by any LDAP syncs.

6 Dial plan configuration – overview

6.1 Introduction

For the Meeting Server to be integrated in a SIP, Lync and voice environment, connections need to be set up from the SIP Call Control, Lync FE Server and Voice Call Control to the Meeting Server. Changes to the call routing configuration on these devices is required in order to correctly route the calls that require the Meeting Server.

Figure 10 assumes a company deployment which has a mix of SIP video endpoints, Lync clients and IP phones: the Meeting Server enables connectivity between Lync clients and SIP video endpoints, and between Lync clients and IP phones.

The SIP video endpoints are configured on a domain called `vc.example.com` and the Lync clients on `example.com`. You will need to adapt the example, as appropriate.

Figure 10: Example deployment for dial plan configuration

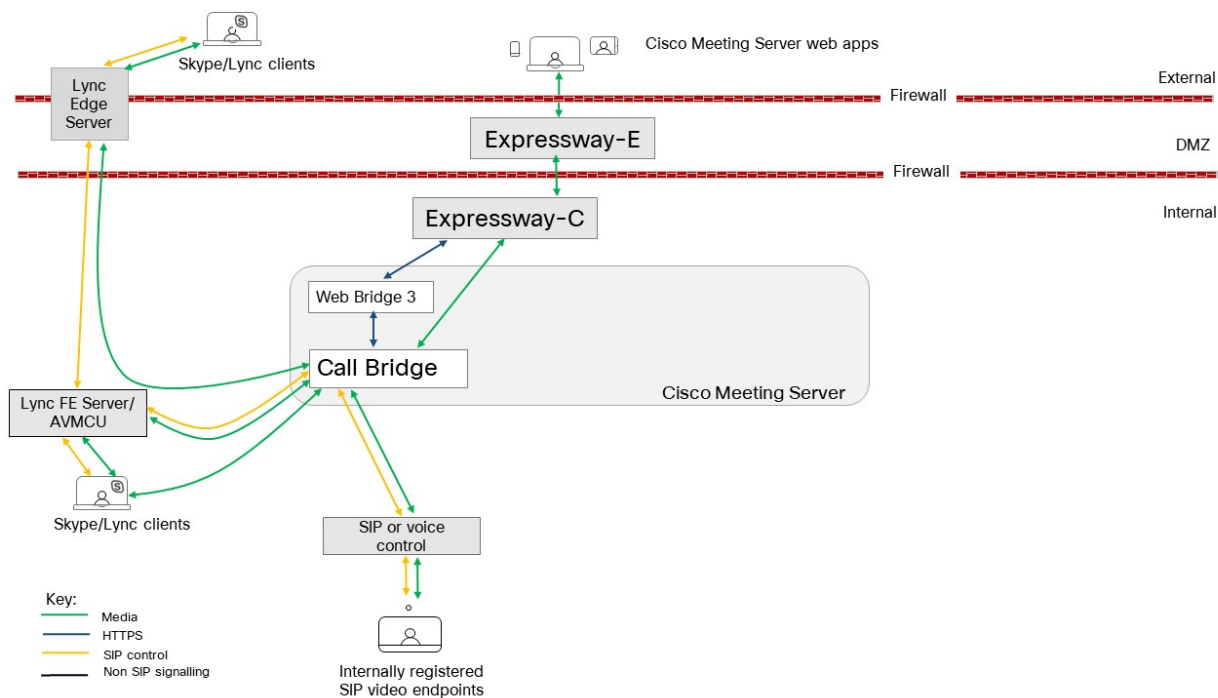

As shown in the figure above, the Lync FE server needs a trusted SIP Trunk to the Meeting Server, configured to route calls originating from Lync clients through to Meeting Server spaces, Cisco Meeting Server Bridge web app users and also SIP video endpoints. The subdomains `vc.example.com` (for SIP video endpoints) and `meetingserver.example.com` (for spaces) should be routed through this trunk from the Lync FE server to the Meeting Server.

Note: Connections to Office 365 or on-premise Lync deployments in another organization, should route to a Cisco Expressway. See the [Expressway deployment guides](#) for more information.

The SIP Call Control platform needs a SIP trunk set up to route calls to the example.com domain (for Lync Clients) and meetingserver.example.com (for spaces and web apps) to the Meeting Server.

The Meeting Server requires a dial plan to route calls with domain example.com to the Lync FE server and subdomain vc.example.com to the SIP Call Control platform.

The next section discusses the two configuration pages in the Web Admin interface of the Meeting Server that determine how the Meeting Server handles incoming calls and outbound calls.

Following this chapter, [Chapter 7](#) and [Chapter 8](#) provide step-by-step instructions on configuring the total solution.

6.2 Web Admin Interface configuration pages that handle calls

This section explains the configuration pages in the Web Admin interface that the Meeting Server uses to determine how to handle each call.

Two configuration pages in the Web Admin Interface control how the Meeting Server behaves for incoming and outgoing calls: **Outbound calls** and **Incoming calls**. The Outbound Calls page controls how outbound calls are handled; the Incoming calls page determines whether incoming calls are rejected. If they are not rejected, but matched and forwarded, then information about how to forward them is required and the Incoming Calls page has two tables – one to configure matching/rejection and the other to configure the forwarding behavior.

6.2.1 Outbound calls page

The Outbound Calls page allows you to configure appropriate dial plans comprising a number of dial plan rules. A dial transform can be applied to Outbound calls to control the routing of the outbound calls, see [Dial Transforms](#).

The screenshot shows the Cisco Web Admin interface for the Outbound calls configuration page. The page has a header with the Cisco logo and navigation tabs for Status, Configuration, and Logs. The user is logged in as 'teresa'. Below the header, there is a 'Filter' input field with 'Submit' and 'Clear' buttons. The main content is a table with the following columns: Domain, SIP proxy to use, Local contact domain, Local from domain, Trunk type, Behavior, Priority, Encryption, Tenant, and Call Bridge Scope. The table contains one row for 'lync.example.com' with the following values: '<none; call directly>', 'callbridge1.example.com', 'example.com', 'Lync', 'Stop', '2', 'Auto', 'no', and 'all'. There are also buttons for 'Add New', 'Reset', and 'Delete'.

	Domain	SIP proxy to use	Local contact domain	Local from domain	Trunk type	Behavior	Priority	Encryption	Tenant	Call Bridge Scope	
<input type="checkbox"/>	lync.example.com	<none; call directly>	callbridge1.example.com	example.com	Lync	Stop	2	Auto	no	all	[Edit]
	<input type="text"/>	<input type="text"/>	<input type="text"/>	<input type="text"/>	Standard SIP	Stop	0	Auto			[Add New] [Reset]

[Delete]

Domain: the domain to match in order to apply the dial plan rule; either a complete value (e.g. "example.com") or a "wildcarded" one (e.g. "*.com").

SIP proxy to use: each entry/rule in a dial plan matches on the Domain of the outgoing call (see below) and determines which SIP proxy to use (or whether it is a direct call).

Local contact domain: is the domain that will be used for the contact URI for calls using this dial plan rule.

CAUTION: If you are using Lync, we suggest that you use the **Local contact domain**. If you are not using Lync we recommend that the **Local contact domain** field is left blank to avoid unexpected issues with the SIP call flow.

CAUTION: For each Lync domain you need to create an outbound rule – follow the procedures described in this section. If you have many Lync domains you can consider creating an outbound rule with a wildcard domain.

Local from domain: is the domain the call uses as its originator ID/Caller ID.

Trunk type: usually, you set up rules to route calls out to third party SIP control devices such as CiscoExpressway, Avaya Manager or Lync servers. Therefore, there are currently three types of SIP trunks you can configure: Standard SIP, Avaya and Lync.

Note: A common use of the Meeting Server is with an Avaya PBX; these calls will be audio-only. However, the Meeting Server does not impose this restriction on interoperability with Avaya products (some of which support video also): therefore a call of type of ‘avaya’ does not imply that the call is audio-only.

Behavior and Priority: Dial plan rules are tried in the order of the Priority values. If a rule is matched, but the call cannot be made, then other lower priority rules may be tried. If a rule has a behavior of STOP, then no further rules are used.

Encryption: select from **Auto**, **Encrypted**, **Unencrypted**.

CAUTION: The default **Encryption** behavior mode is **Auto**. Ensure all "Lync" outbound dialing rules are explicitly set to **Encrypted** mode to prevent the Call Bridge attempting to use unencrypted TCP for these connections in the event of the TLS connection attempt failing.

6.2.2 Incoming call page: call matching

The top table in the Incoming Call page is the Call Matching table. The rules defined in the Call Matching table govern how the Meeting Server handles incoming SIP calls. Any call routed to the Meeting Server on any domain can be tested for a match for IVRs, web app users or for preconfigured spaces on that server.

The example Call matching rule below seeks to match all calls coming in on the meetingserver.example.com domain to both web app users and spaces.

The screenshot shows the Cisco Meeting Server configuration page for 'Incoming call handling'. Under the 'Call matching' section, there is a table with the following data:

Domain name	Priority	Targets spaces	Targets IVRs	Targets Lync	Targets Lync: SimpleJoin	Tenant
meetingserver.example.com	10	yes	yes	no	no	no

Below the table, there are controls for 'Add New' and 'Reset', and a 'Delete' button for the first rule.

For example, if the incoming call was to `name.space@meetingserver.example.com` and there was a configured space called `name.space` the call would be routed to the space with that name.

It is recommended that rules are created for every domain expected for incoming calls. With some call control solutions the domain may be the IP address or hostname of the server. In these cases the highest priority domain is expected to be the main domain, with IP address and hostname rules having lower priority.

Rules with a higher priority value are matched first. In cases where multiple rules have the same priority then matching occurs based on alphabetical order of the domain.

After a rule is executed rules further down the list are ignored for the call.

If all Call Matching rules fail, the next table (Call Forwarding) is used as described in the next section.

Points to note:

- Matching for space and/or users is only done on the part of the URI before the @.
- The highest priority rule that matches a space is used to form the URI in the invitation text. It is expected that the highest priority rules are for the deployment as a whole rather than for individual IP addresses or hostnames.
- Do not leave the **Domain** field blank in a rule, otherwise the Call Bridge will refuse the call.
- No rules in the Call matching table will result in all domains being matched.

6.2.3 Call forwarding

If an incoming call fails to match any of the rules in the Call Matching table, the call will be handled according to the Call Forwarding table. In this table you can have rules to decide whether to reject the call outright or to forward the call in bridge mode, for example resolving to a Lync conference. By defining rules, you decide whether to forward the call or not. It might be appropriate to “catch” certain calls and reject them.

Rules can overlap, and the **Domain matching pattern** can include wildcards, for example: `exa*.com`; but do not use “*” as a match all, otherwise you will create call loops. Order rules using the **Priority** value; higher numbered rules are tried first.

For calls that will be forwarded, you can rewrite the destination domain using the **Forwarding domain**. A new call is created to the specified domain. The **Caller ID** setting allows the forwarded call to either preserve the original calling party’s ID or to generate a new one. Select

pass through to preserve the calling party's ID or **use dial plan** to generate a new calling party ID according to your call routing configuration.

The example Call Forwarding rule below forwards calls for the domain lync.example.com and the routing is determined by the call routing rules.

Call forwarding							
	Domain matching pattern	Priority	Forward	Caller ID	Rewrite domain	Forwarding domain	
<input type="checkbox"/>	lync.example.com	50	forward	pass through	no		[edit]
<input type="checkbox"/>	<input type="text"/>	<input type="text" value="0"/>	reject ▼	use dial plan ▼	no ▼	<input type="text"/>	<input type="button" value="Add New"/> <input type="button" value="Reset"/>

An incoming call is terminated if does not match any of the rules in the Call Matching table and does not match any of the **Domain matching patterns** in the Call Forwarding table.

6.3 Dial Transforms

Dial Transforms are applied to outgoing calls prior to the Outbound rules taking effect. When dial transforms are applied, the outbound dial plan rules are applied to the transformed number. Dial Transforms only affect Outbound calls, they do NOT affect gateway calls.

There are three stages to the transform:

- A “type” is applied, which defines the type of preprocessing to apply to the transform.
 - Raw: produces one component - \$1
 - Strip: removes dots, dashes, spaces and produces one component - \$1
 - Phone: use to transform to an international phone number - produces two components \$1country code and \$2number

Note: A phone URI is recognized as a purely numeric string (optionally prefixed by a '+') when it begins with a valid international dial code (e.g. 44 for UK or 1 for US) followed by the correct number of digits for a phone number for that region.

- The components are matched using regular expressions to see if the rule is valid
- An output string is created from the components according to the defined transform

Examples

Example	Type	Match	Transform
For US numbers, use 'vcs1' directly	Phone	(\$1/01/)	\$2@vcs1
For UK numbers, add a prefix and use 'vcs2'	Phone	(\$1/44/)	90044\$2@vcs2
For UK numbers starting with a 7, add '90044' as a prefix, add '123@mobilevcs' as a suffix	Phone	(\$1/44/)(^7/)	90044\$2{}123@mobilevcs
For unrecognized all-digit strings, use '@vcs3' as a suffix	Strip	(\$1/(\d){6,}/)	\$1@vcs3
Replace + with 00	Strip	(\$1/\+(\d)+/)	\$1{/+/00/}
Replace an alphanumeric regex e.g. (.*)@example.com and replace with \1.endpoint@vc.example.com	Raw	(\$1/(.*)@example.com/)	\$1{/@example.com\$/ .endpoint@vc.example.com/}

For a single Meeting Server, use the **Configuration > Outbound Calls** page in the Web Admin Interface to control how dialed numbers are transformed. If a match expression is provided, the regular expression determines whether the specified transform expression is applied

For example, the dial plan in the screen shot below ensures that outbound "+1" (US) calls use one Call Bridge and +44 (UK) calls use another.

7 Dial plan configuration – SIP endpoints

7.1 Introduction

This chapter describes the configuration to enable SIP video endpoints to dial into a meeting hosted on the Meeting Server. Work through the steps in the order provided, adapting the example as appropriate.

7.2 SIP video endpoints dialing a meeting hosted on the Meeting Server

This first step considers the configuration required on the call control device and on the Meeting Server to direct SIP video endpoints to meetings hosted on the Meeting Server.

Figure 11: Example of SIP video endpoints calling into Meeting Server hosted calls

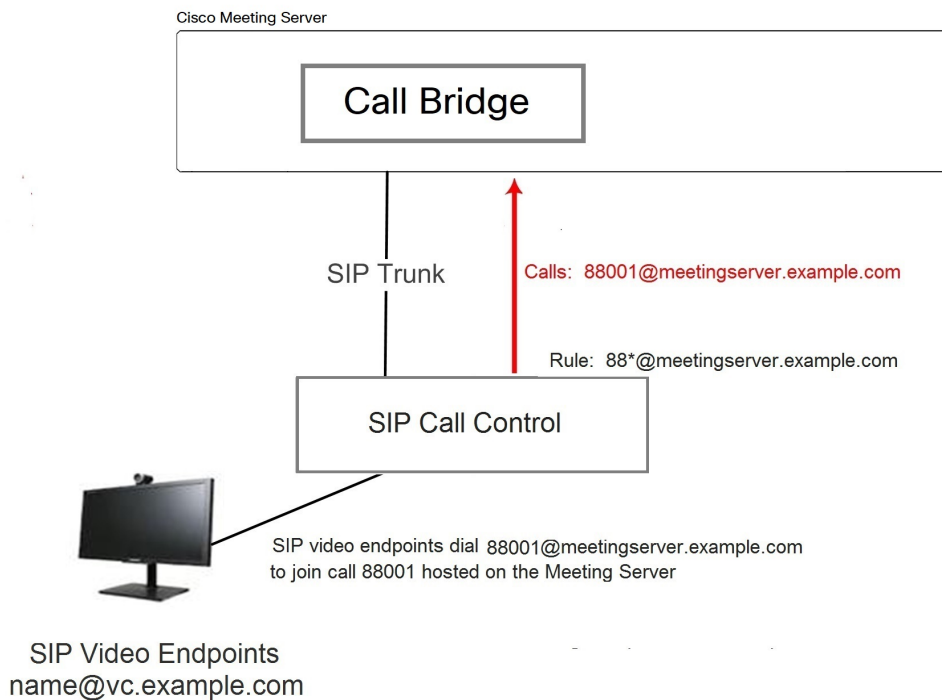

7.2.1 SIP call control configuration

This example assumes the SIP Call Control is a Cisco VCS, but similar steps are required on other call control devices, for example using the Cisco Unified Communications Manager, see the Cisco Meeting Server with Cisco Unified Communications Manager Deployment Guide.

1. Sign in to the VCS as an administrator.
2. Set up a zone to route calls to the Meeting Server
 - a. Go to **VCS Configuration > Zones > New**.
 - b. Create the zone with the following:
 - H.323 Mode = Off.
 - SIP Mode = On
 - SIP Port = 5060 (5061 if using TLS)
 - SIP Transport = TCP or TLS, as appropriate
 - SIP Accept Proxied Registrations = Allow
 - Authentication Policy = Treat as authenticated
 - SIP Authentication Trust Mode = Off
 - Peer 1 Address = the IP address of the Call Bridge
3. Add a search rule to route calls to the Meeting Server. For example to route any calls on SIP endpoints to a meeting on the Meeting Server using the domain **meetingserver.example.com**.
 - a. Go to **VCS Configuration > Dial Plan > Search rules**
 - b. Give the rule a suitable name, e.g. **Route EPs to Meeting Server**.
 - c. Set the following:
 - Source = Any
 - Request Must Be Authenticated = No
 - Mode = Alias pattern match
 - Pattern Type = Regex
 - Pattern String = **.*@meetingserver.example.com**
 - Pattern Behavior = Leave
 - On Successful Match = Stop
 - Target = the zone you created for the Meeting Server.

7.2.2 Meeting Server configuration

1. Sign in to the Web Admin Interface on the Meeting Server.
2. Either create a space on the Meeting Server for endpoints to dial into:
 - a. Go to **Configuration >space**
 - b. Add a space with:

- **Name** =<string>, for example. **Call 001**
- **URI** =<user part of the URI>, for example. **88001**

or use an already existing space.

Note: spaces can also be created or modified from the API. See the [API Reference guide](#).

3. Add an inbound dial plan rule for incoming calls to the Meeting Server.
 - a. Go to **Configuration > Inbound Calls** and add a dial plan rule with the following details:
 - **Domain name** = <FQDN of the Meeting Server>, for example **meetingserver.example.com**
 - **Targets spaces** = **yes**
 - **Targets IVRs** = **yes**
 - optional **Targets users** = **yes**
 - **Targets Lync** = **yes** Note: this is required later in [Section 8.1.2](#)

Note: See [Section](#) for more information on the **Inbound calls** page of the Web Admin interface.

4. Add an outbound dial plan rule for outbound calls to SIP endpoints via the VCS.
 - a. Go to **Configuration > Outbound Calls** and add a dial plan rule with the following details:
 - **Domain** =<domain to match> such as **example.com** or ***.com**
 - **SIP Proxy to use** = <the IP address or FQDN of your VCS>
 - **Local Contact Domain** =

Note: The local contact domain field should be left blank unless setting up a trunk to Lync (as in [Section 8.1.2](#)).

- **Local From Domain** = <FQDN of the Meeting Server>
- **Trunk type**=**Standard SIP**.

Note: See [Section](#) for more information on the **Outbound calls** page of the Web Admin interface.

SIP video endpoints can now dial into a call 88001 hosted on the Meeting Server by dialing **88001@meetingserver.example.com**, and the Meeting Server can call out to SIP endpoints.

Before moving onto creating dial plans for Lync in [Chapter 8](#), consider whether to:

- configure the media encryption setting, see [Section 7.3](#),
- enable TIP support for Cisco CTS endpoints, see [Section 7.4](#),
- configure an Interactive Voice Response (IVR), see [Section 7.5](#).

7.3 Media encryption for SIP calls

The Meeting Server supports media encryption for SIP connections, including Lync calls, made to or from the Meeting Server. This is configured in the **Configuration > Call settings** page in the Web Admin Interface.

1. Sign in to the Web Admin Interface and go to **Configuration > Call settings**
2. Select the appropriate **SIP media encryption** setting (**allowed**, **required** or **disabled**).
3. Change the bandwidth settings for SIP, CMA (web app) or Server reflexive.
4. To select applying these changes to SIP calls already in progress, click the **Apply to Active Calls** button at the end of the page, or to select applying these changes to future SIP calls click the **Submit** button.

Note: The SIP Encryption field in the Web Admin Interface **Configuration > Outbound Calls** page allows you to set the SIP control encryption behavior for each [Outbound Calls](#) rule. This separates the control and media encryption behavior, allowing a TLS control connection to be used in the absence of media encryption; you can also set the behavior via the API.

7.4 Enabling TIP support

If you use endpoints such as the Cisco CTS range, you need to select TIP protocol support. Enable it as follows:

1. In the Web Admin Interface go to **Configuration > Call settings** and in the SIP Settings section, set TIP (Telepresence Interoperability Protocol) to **enabled**.

Call settings

Call settings

SIP media encryption

SIP call participant labels

Audio packet size preferred

SIP settings

TIP (Telepresence Interoperability Protocol) calls

- Set both SIP Bandwidth Settings to at least 4000000.

Bandwidth settings (SIP)	
Rx bandwidth	<input type="text" value="4000000"/>
Tx bandwidth	<input type="text" value="4000000"/>

- Click **Submit**.

7.5 IVR configuration

You can configure an Interactive Voice Response (IVR) to manually route to pre-configured calls. Incoming calls can be routed to the IVR where callers are greeted by a prerecorded voice message inviting them to enter the ID number of the call or space that they want to join. Video participants will see a welcome splash screen. After entering the ID, users are routed to the appropriate call or space, or prompted to enter a PIN if the call or space has one. (Callers are disconnected after the third incorrect call ID.)

If you intend to use an IVR follow these instructions:

- Sign into the Web Admin Interface and go to **Configuration > General**.
- In the **IVR** section, configure the following:
 - IVR numeric ID** = <numeric call ID that users call to reach the IVR>
 - Joining scheduled Lync conferences by ID**= “not allowed” or “allowed” depending on your policy.
- On **Configuration > Incoming Calls** set **Target IVRs** = "yes" to match incoming calls to the IVR.
- Configure the appropriate routing on your SIP Call Control to ensure that calls to the numbers set in the previous step are routed to the Meeting Server.

7.6 Next steps

Now follow the steps in [Chapter 8](#) to configure dial plans to integrate Meeting Server with Lync deployments.

8 Dial plan configuration – integrating Lync/Skype for Business

Throughout this chapter, references to Microsoft Lync also mean Microsoft Skype for Business.

Note: For Call Bridge integration with Lync Edge, the Call Bridge needs its own login account. For each Lync call to or from the Call Bridge, the server requests TURN resources from the Lync Edge using that account. Until that call is disconnected, that resource is considered "Used" from a Lync point of view. Lync will only allow up to 12 TURN allocations per user account; therefore, with 1 registration, only 12 calls are possible.

8.1 Lync clients dialing into a call on the Meeting Server

This section details the configuration required to enable Lync endpoints to join a meeting hosted on the Meeting Server. It uses the same call number/URI as used in [Section 7.2](#); adapt the example as appropriate.

Figure 12: Example Lync clients calling into Meeting Server hosted meetings

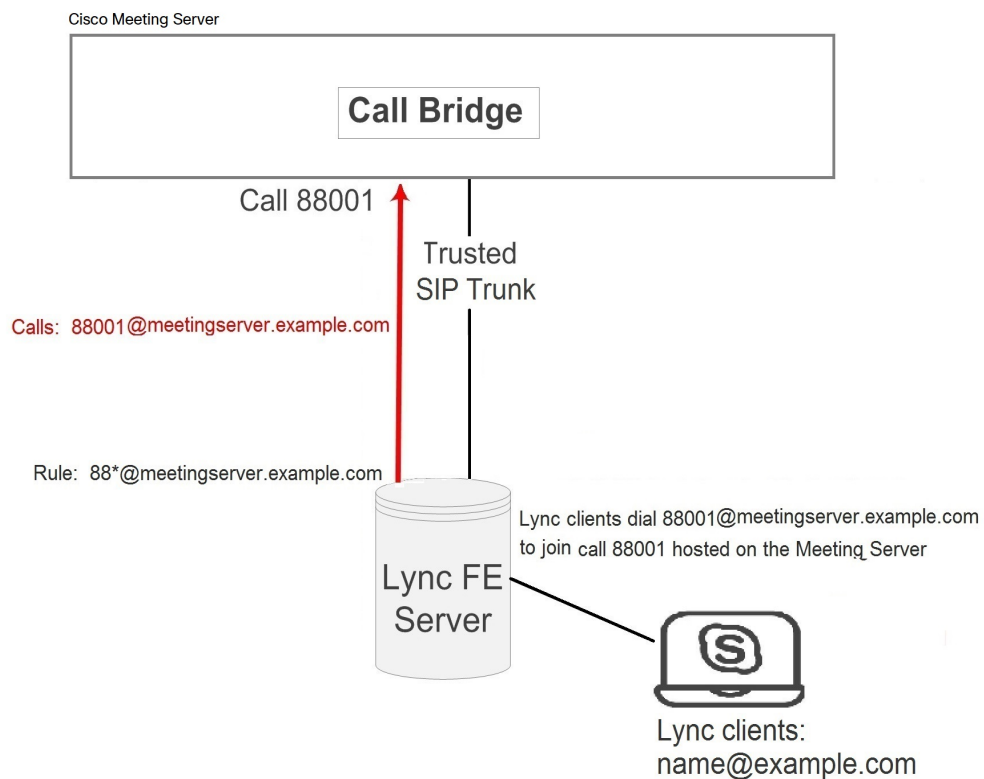

8.1.1 Lync Front End (FE) server configuration

CAUTION: This section provides an example for configuring a static route between a Lync FE server and the Meeting Server, it is only a guideline and is not meant to be an explicit set of instructions for you to follow. Cisco strongly advises you to seek the advice of your local Lync server administrator on the best way to implement the equivalent on your server's configuration.

Note: Before configuring a static route from the Lync FE server, ensure that you have installed certificates on the Meeting Server which will be trusted by the Lync FE server – as described in the [Certificate Guidelines](#).

To route calls originating from Lync clients to the Meeting Server, add a Lync static route pointing to the Meeting Server. This involves setting the Meeting Server as a trusted application for the Lync FE server and adding the static route.

1. Open the Lync Server Management Shell.
2. Create a new application pool that will contain the Meeting Server as a trusted application.

```
New-CsTrustedApplicationPool -Identity fqdn.meetingserver.com -ComputerFqdn
fqdn.meetingserver.com -Registrar fqdn.lyncserver.com -site 1 -
RequiresReplication $false -ThrottleAsServer $true -TreatAsAuthenticated
$true
```

Replacing

- `fqdn.meetingserver.com` with the FQDN of the Meeting Server, the identity MUST be the CN specified in the Call Bridge's certificate.
- `fqdn.lyncserver.com` with your Lync FE Server or FE Pool FQDN

3. Add the Meeting Server as a trusted application to the application pool.

```
New-CsTrustedApplication -ApplicationId meetingserver-application -
TrustedApplicationPoolFqdn fqdn.meetingserver.com -Port 5061
```

Replacing

- `meetingserver-application` with name of your choice
- `fqdn.meetingserver.com` with the FQDN of the Meeting Server

4. Create the static route between the Meeting Server and the Lync FE server.

```
$x=New-CsStaticRoute -TLSSRoute -Destination "fqdn.meetingserver.com" -
MatchUri "meetingserver.example.com" -Port 5061 -UseDefaultCertificate
$true
```

Replacing

- `fqdn.meetingserver.com` with your FQDN of the Meeting Server
 - `meetingserver.example.com` with the URI matching the domain used for all of your Meeting Server calls.
5. Add the new static route to the existing collection of static routes
`Set-CsStaticRoutingConfiguration -Identity global -Route @{Add=$x}`
 6. Optional. Before enabling the static route, consider changing the default screen resolution for Lync calls from the default of VGA to HD720p. To enable HD720p on Lync:
`Set-CsMediaConfiguration -MaxVideoRateAllowed Hd720p15M`
 7. Enable the new static route.
`Enable-CsTopology`

Note: Users may have to logout and login again to update to the new HD720p setting, all other settings are automatic and should work within a few minutes.

8.1.2 Adding a dial plan rule on the Meeting Server

1. Sign in to the Web Admin Interface of the Meeting Server, go to **Configuration > Outbound Calls**
2. At the bottom of the Outbound calls table, create a new dial plan rule
 - a. In the **Domain** field, enter the Lync domain that will be matched for calls that need to be sent to Lync. For example, `example.com`
 - b. **SIP Proxy to Use** field, enter the address (IP address or FQDN) of the proxy device through which to make the call.
 - Either leave this field blank and the server will perform a DNS SRV lookup for the called domain using `_sipinternaltls._tcp.<yourlyncdomain>.com`
 - or enter the IP address or FQDN of the Front End Pool (or Lync sip domain) and the server will first perform a DNS SRV lookup for that defined domain using `_sipinternaltls._tcp.<Server address>.com` and then perform a DNS A record lookup for the Host entered if the SRV lookup fails to resolve
 - or enter the IP address or FQDN of your Lync FE server
 - c. **Local Contact Domain** field, enter the FQDN of your Meeting Server. For example: `meetingserver.example.com`

Note: The only case in which this field should be set is when setting up a trunk to Lync; otherwise it should be left blank.

- d. **Local From Domain** field, enter the domain that you want the call to be seen as coming from (the Caller ID) e.g. `meetingserver.example.com`

Note: If you leave **Local From Domain** blank, the domain used for the Caller ID defaults to that entered as the Local Contact Domain.

- e. **Trunk Type** field, select **Lync**
- f. In the **Behavior** field, select **stop** or **continue** depending on whether the next outbound dial plan rule is tried if this rule fails to result in a connected call.
- g. **Priority** field, assign a Priority level to determine the order in which dial plan rules will be applied. Rules with higher priority values are applied first.
- h. **Encryption** field, select **Auto**, **Encrypted** or **Unencrypted** according to whether encrypted SIP control traffic on calls made via this rule, is enforced.
- i. Select **Add New**.

Note: Tenant and Call Bridge scope can only be set through the API.

After completion you should be able to call from the Lync environment to the Meeting Server and from the Meeting Server to Lync.

In the example, the Lync clients can now dial into a call 88001 hosted on the Meeting Server by dialing 88001@example.com.

8.2 Integrating SIP endpoints and Lync clients

To allow SIP endpoints to dial a Meeting Server space, implement the steps in [Section 7.2](#); to allow Lync clients to dial a Meeting Server space, implement [Section 8.1](#).

Then both SIP video endpoint users and Lync client users can enter the same call by dialing `<call_id>@meetingserver.example.com`

Figure 13: Example of SIP video endpoints and Lync clients calling into Meeting Server hosted meetings

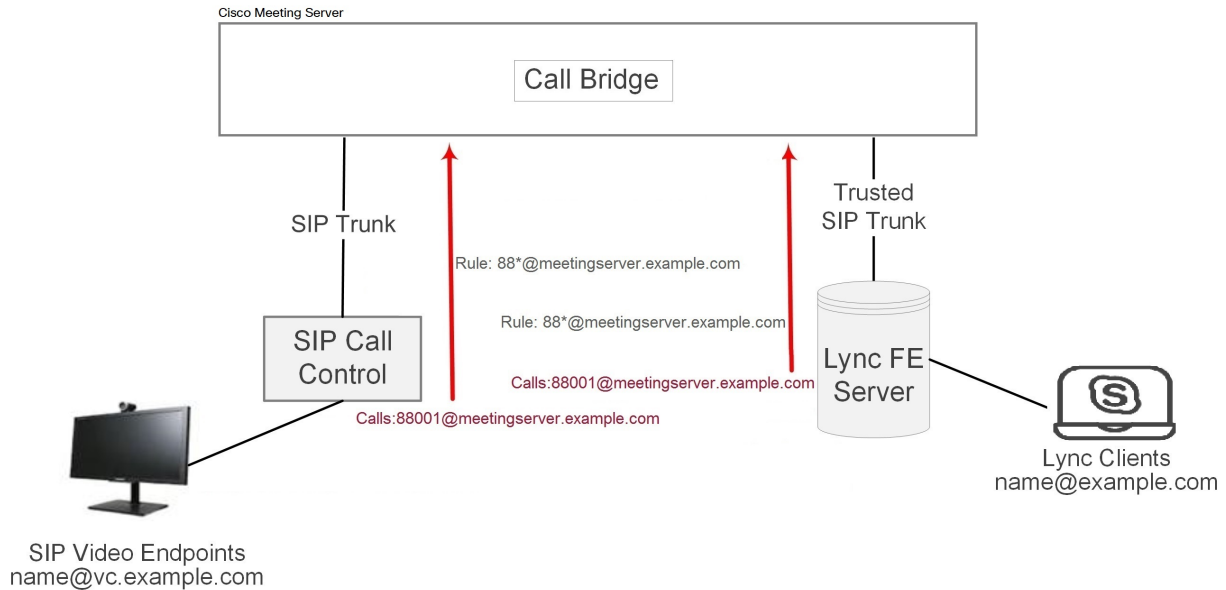

8.3 Adding calls between Lync clients and SIP video endpoints

This section assumes the completion of the configuration described in the two dial plan configuration sections ([Section 7.2](#) and [Section 8.1](#)). It expands the example to allow Lync and SIP video endpoints to call each other in a call using the Meeting Server as a gateway to transcode the video and audio (see the figure below).

Note: The Outbound Calls page was used previously to set up a SIP trunk from the Meeting Server to the Cisco VCS. In order to configure the Meeting Server to act as a “point-to-point bridge” between Lync and SIP environments, you need to configure call forwarding as described in this section and also set up a SIP trunk from the Meeting Server to other SIP call control devices you are using such as the Lync FE server, Cisco VCS, CUCM, Avaya CM or Polycom DMA.

Figure 14: Example of SIP video endpoints and Lync clients in calls

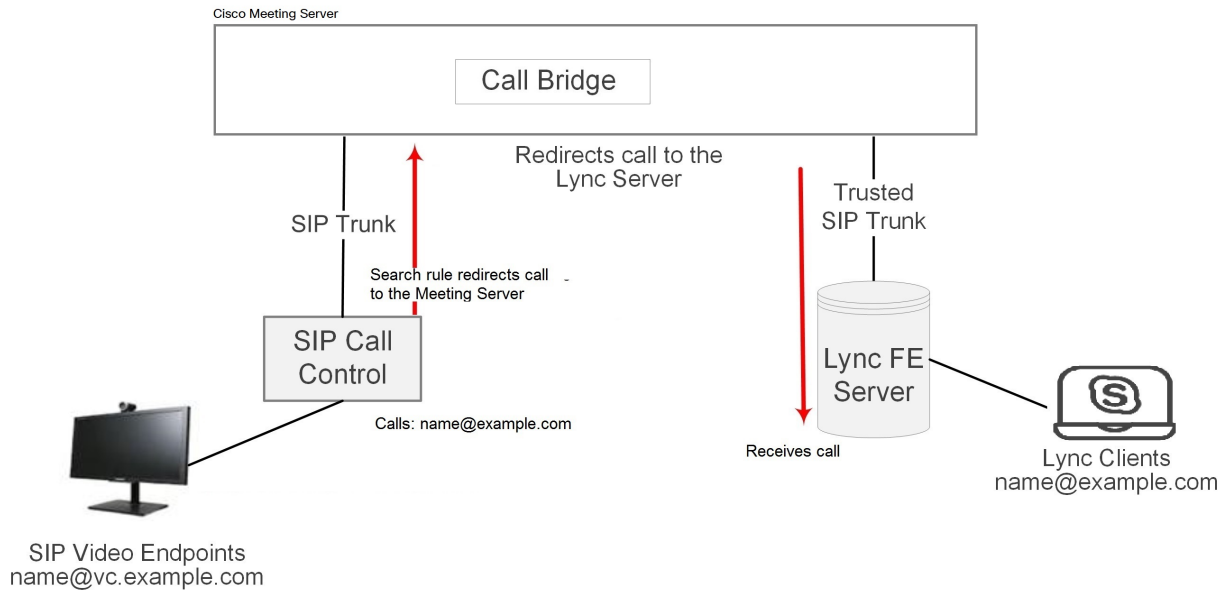

In this example:

- A Lync user can dial `<name>@vc.example.com` to set up a call with a SIP video endpoint, for example `meetingroom1@vc.example.com`.
- A SIP video endpoint can dial `<name>@example.com` to set up a call with a Lync endpoint, for example `roberta.smith@example.com`.

Adapt the example as appropriate.

8.3.1 Lync Front End server configuration

To allow Lync clients to call SIP video endpoints:

- Add a Lync static route pointing to the Meeting Server that will redirect calls for `@vc.example.com`. Follow the steps on creating a Lync static route given in [Section 8.1](#)

this will route Lync client calls to SIP video endpoints.

8.3.2 VCS configuration

To allow SIP video endpoint to call Lync clients:

- Add a search rule on the VCS (SIP call control device) to route calls with the suffix `@example.com` to the Meeting Server.

this will route SIP video endpoint calls to Lync clients.

8.3.3 Meeting Server configuration

Create two forwarding rules on the Meeting Server, one to forward calls to SIP endpoints, and the other to forward calls to Lync clients. Then create two outbound dial plan rules one to route outbound calls to SIP endpoints, and the other to route outbound calls to Lync clients.

1. Sign in to the Web Admin Interface and go to **Configuration > Incoming Calls**.
2. In the **Call forwarding** section, create two new rules:
 - a. Create a call forwarding rule for calls to vc.example.com
 - **Domain matching pattern** = **vc.exa*.com**
Wildcards are permitted in any part of a domain matching pattern, but do not use “*” as a match all, otherwise you will create call loops.
 - **Priority** = <number> any value is acceptable, including 0 if there are no other forwarding rules configured. To ensure a rule is always used, set its priority as the highest of any rules configured.

(Rules are checked in order of priority; highest priority first. If two Domain Matching Patterns match a destination domain, the rule with the higher priority is used.)
 - **Forward** = **forward**

(If you select “reject”, calls that matched the Domain Matching Pattern are not forwarded but terminate.)
 - **Caller ID** = **use dial plan** this will use the domain from the outbound dial plan.
 - **Rewrite Domain** = **no**
The call will be forwarded using the domain that was called.

(If you select yes here, you must then complete the **Forwarding domain** field. The original domain will be replaced with the one you enter in **Forwarding domain** before the call is forwarded.)
 - Click **Add new**
 - b. Create a call forwarding rule for calls to example.com
 - **Domain matching pattern** = **exa*.com**
 - **Priority**: <number>
 - **Forward** = **forward**
 - **Caller ID** = **use dial plan**
 - **Rewrite Domain** = **no**
 - Click **Add new**.
3. Go to **Configuration>Outbound calls** page, create two new rules:

- a. Create a dial plan for calls to domain vc.example.com for SIP endpoints, this is a repeat of step 4 in [Section 7.2.2](#).
- In the **Domain** field, enter the SIP domain that will be matched for calls that need to be sent to SIP endpoints. For example, **vc.example.com**
 - **SIP Proxy to use**= <the IP address or FQDN of your VCS>
 - **Local Contact Domain** =
-
- Note:** The local contact domain field should be left blank.
-
- **Local From Domain** = <FQDN of the Meeting Server>
 - **Trunk type**=**Standard SIP**.
 - Select **Add New**.
- b. Create a dial plan rule for calls to domain example.com for Lync clients, this is a repeat of [Section 8.1.2](#).
- In the **Domain** field, enter the Lync domain that will be matched for calls that need to be sent to Lync. For example, **example.com**
 - **SIP Proxy to Use** field, enter the address (IP address or FQDN) of the proxy device through which to make the call.
 - Either leave this field blank and the server will perform a DNS SRV lookup for the called domain using **_sipinternaltls._tcp.<yourlyncdomain>.com**
 - or enter the IP address or FQDN of the Front End Pool (or Lync sip domain) and the server will first perform a DNS SRV lookup for that defined domain using **_sipinternaltls._tcp.<yourlyncdomain>.com** and then perform a DNS A record lookup for the Host entered if the SRV lookup fails to resolve
 - or enter the IP address or FQDN of your Lync FE server
 - **Local Contact Domain** field, enter the FQDN of your Meeting Server. For example: **meetingserver.example.com**
-
- Note:** The only case in which this field should be set is when setting up a trunk to Lync; otherwise it should be left blank.
-
- **Local From Domain** field, enter the domain that you want the call to be seen as coming from (the Caller ID), this will be the FQDN of the Call Bridge, e.g. **meetingserver.example.com**
-
- Note:** If you leave **Local From Domain** blank, the domain used for the Caller ID defaults to that entered as the Local Contact Domain.
-
- **Trunk Type** field, select **Lync**

- In the **Behavior** field, select **stop** or **continue** depending on whether the next outbound dial plan rule is tried if this rule fails to result in a connected call.
- **Priority** field, assign a Priority level to determine the order in which dial plan rules will be applied. Rules with higher priority values are applied first.
- **Encryption** field, select **Auto**, **Encrypted** or **Unencrypted** according to whether encrypted SIP control traffic on calls made via this rule, is enforced.
- Select **Add New**.

SIP video endpoints can now call Lync clients by dialing `<name>@example.com`, and Lync clients can call SIP video endpoints by dialing `<endpoint>@vc.example.com`.

8.4 Integrating web app with SIP and Lync clients

Note: web app users are not permitted to call out to Lync meetings.

Refer to the sections on [LDAP Configuration](#) for instructions on configuring your Meeting Server to use the web app.

If you are using the same LDAP configuration to create both Lync accounts and web app accounts, and using the Meeting Server as a Lync gateway, then problems can occur with users calling web app clients rather than the intended Lync client. To prevent this happening set up rules for Call matching and Call forwarding, this is explained below.

For example, assume there is an account `fred@example.com` on the Meeting Server and a `fred@lync.example.com` account on the Lync FE server. If a call arrives at the Meeting Server and no Call matching rules are configured, the Meeting Server will ignore the domain and the call will go to the Meeting Server's `fred@example.com` account. The Meeting Server checks whether there is a user "fred" locally, ignoring the `xxxx` in `fred@xxxx`.

The solution is to configure a **Call matching** rule on the **Incoming Calls** page to match the domain for local web app users and a **Call forwarding** rule to forward calls to Lync clients. For the **Call matching** rule, set the **Domain name** field to something distinct from the domain that the Lync FE server uses, for example `example.com`. In the **Call forwarding** section create a rule specifying the Lync domain in the **Domain matching pattern** field, for example `lync.example.com`. A call to `fred@example.com` will reach the web app user but a call to `fred@lync.example.com` will be forwarded to Fred's Lync client.

8.5 Integrating Lync using Lync Edge service

For NAT traversal using the Lync Edge server, follow the configuration steps in this section to configure Lync Edge settings on the Meeting Server. This is required to support [Dual Homed Conferencing](#) or if the Lync Edge performs the TURN/ICE role for Lync calls, rather than the Meeting Server.

8.5.1 Lync Edge call flow

To establish a call from the Meeting Server to the Lync Edge server (see Figure 15 below):

1. The Call Bridge makes a “register” SIP call to the Lync FE server.
2. The “register” is acknowledged.
3. The Call Bridge sends a “service” to the Lync FE server.
4. The FE server returns the URI of the media relay authentication server (MRAS). (The Lync Edge Server acts as a MRAS.)
5. The Lync client initiates an incoming call.
6. The Call Bridge sends “service” messages to the Lync FE server to request MRAS credentials to use the Lync Edge MRAS service
7. The Lync FE server returns the credentials for the Call Bridge to use, as well as the UDP and TCP ports, and the MRAS URI once again
8. The Call Bridge resolves this MRAS URI using DNS and starts sending STUN messages directly to the Lync Edge server
9. The call media then flows directly between the Call Bridge and Lync Edge’s TURN server on UDP port 3478 and returns from the Lync Edge server to the Call Bridge on a port in the ephemeral range above.

Therefore the following ports need to be opened in the firewall for the media between Call Bridge and the Lync Edge server: UDP 3478 outgoing and 32768-65535 incoming.

Figure 15: Call Bridge to Lync Edge server call flow

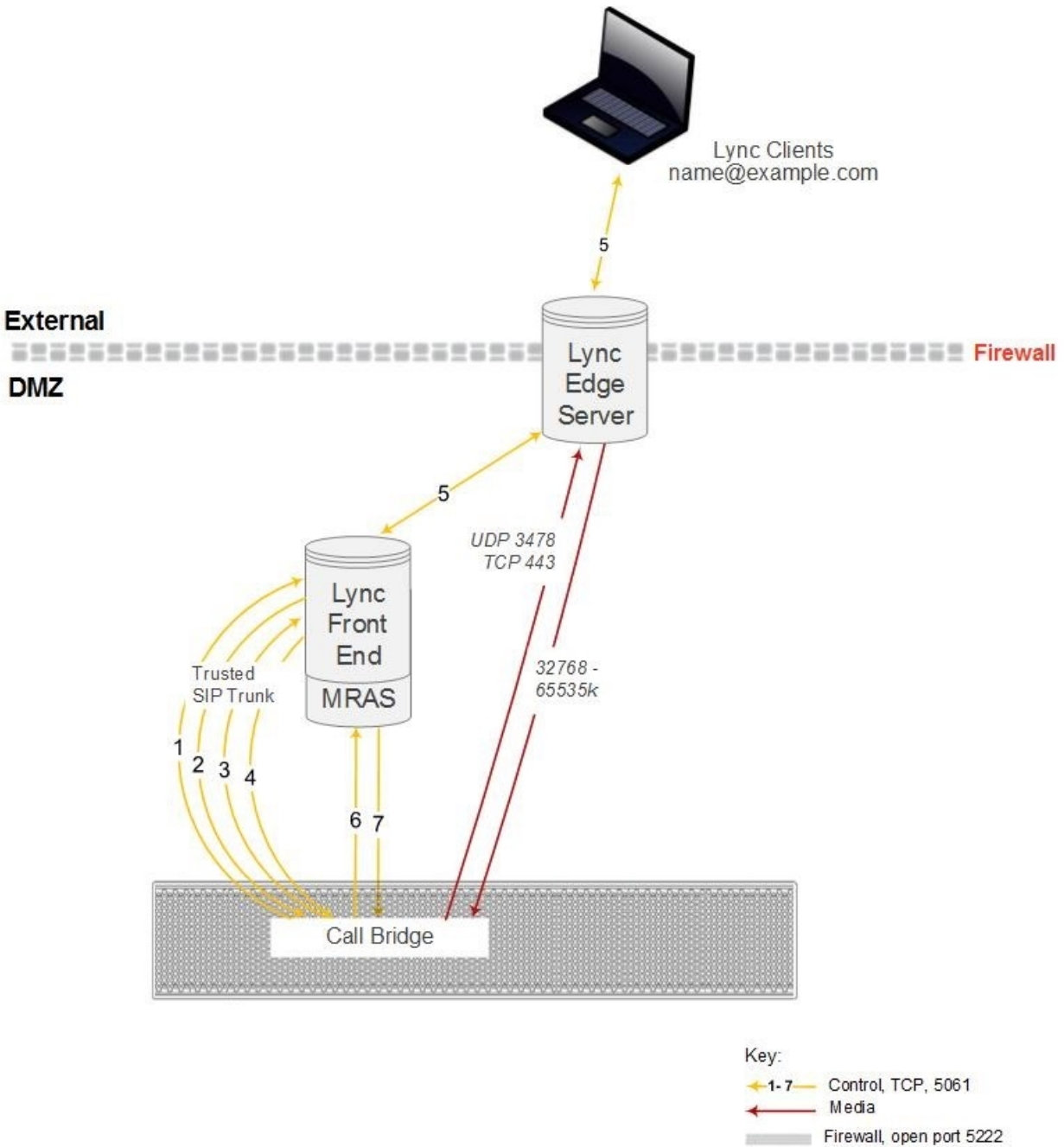

8.5.2 Configuration on Meeting Server to use Lync Edge

To use a Lync Edge server, log into the Web Admin Interface of the Meeting Server, go to **Configuration > General** and configure the Lync Edge Settings. (When a Lync Edge server is configured, it takes the TURN / ICE role for Lync calls, and so at some level is an alternative to the TURN server settings above).

You also need to create a Lync user client account to set up the Meeting Server- Lync Server Edge configuration.

Follow these steps to set up the Meeting Server to use the Lync Edge server:

1. Ensure that you have the appropriate DNS records in place; see [Appendix 1](#) for a list of DNS records needed for the combined server type deployment.
2. Create a new user in your LDAP directory, just as you would any other user in your directory, for example, `firstname="edge", second name = "user"`.
3. Log into the user manager on your Lync FE Server and create a Lync Client user from the user you created in the previous step. Do this in the same way as you would any other user to enable them to use Lync. Using the example name above creates a Lync client user called `edge.user@lync.example.com`
4. Sign in to the Web Admin Interface of the Meeting Server, and go to **Configuration > General**. Configure the Lync Edge Settings by entering the Lync FE Server Address (or a host name that resolves to this). For Username enter the Lync client user name created in the previous step.
5. Complete the Number of Registrations field, if necessary.

This field overcomes a feature of the Lync Edge server that limits the number of simultaneous calls that it will run for one registered device. By entering a number greater than 1, the Call Bridge will make that number of registrations, thereby increasing the number of simultaneous calls that the Meeting Server can make out through the Lync Edge Server.

Entering a number greater than 1 adds a number to the end of your Lync Edge username and registers with the resulting username. For example, if you configured Username as `edge.user@lync.example.com` and set Number of Registrations to 3, you will need to create the following users in your Lync environment so that they can be used with the Edge server:

`edge.user1@lync.example.com`
`edge.user2@lync.example.com`
`edge.user3@lync.example.com`

We recognize that this requires some administrative overhead; however it is due to a limitation of the Lync Edge server as explained above.

Leave the Number of Registrations blank to only make a single registration as `edge.user@lync.example.com`.

Note: There is no need to enter the password for the Lync users because the Lync FE server trusts the Call Bridge.

Points to note about configuring the Lync Edge:

- The Meeting Server supports Lync content (presentations contributed over RDP) from external Lync clients whose media arrives via the Lync Edge server. In addition, space (URIs) now report back as busy or available based on how many participants are currently in the space so that Lync clients that have spaces in their favorites can see the space status.
- If you are using a Lync AVMCU, you need to configure the Lync edge settings in order to register with the Lync FE server.
- web apps continue to use the Meeting Server TURN server even if a Lync Edge server is configured.
- If you have a Lync Edge server configured, all Lync calls will use that server for ICE candidate gathering and external media connectivity. If you do not have a Lync Edge server configured, but have configured a Cisco Expressway in your deployment, then the Lync calls will be handled by the configured TURN server in the Expressway.
- In a typical Lync Edge deployment, the internal interface of the Lync Edge server will not have a default gateway defined; only the external interface has a default gateway defined. If the Call Bridge interface is not on the same local subnet as the internal interface of the Lync Edge server, then you must define a static and persistent network route to the Lync Edge server so it can route packets to the Meeting Server correctly, using the internal interface. To add a static and persistent network route to the Lync Edge Server, open CMD and issue the command below , replacing the example data with your own IP information.

Example Command:

```
route add -p 10.255.200.0 mask 255.255.255.0 10.255.106.1
```

In this example a network route is added that allows the entire subnet of 10.255.200.0 to route through the gateway of 10.255.106.1; 10.255.106.1 is the gateway of the subnet for the internal interface on the Lync Edge server.

Failure to add this route will result in all STUN packets sent by the Meeting Server to the Lync Edge server to go unanswered, which can result in call failures.

8.6 Direct Lync federation

The Meeting Server supports direct federation with Microsoft Lync, by putting the Call Bridge on a public IP address with no involvement from NAT. This allows calls to be made from the Meeting Server direct to any Lync domain and vice versa.

To allow inbound calls you must:

1. Create the DNS SRV record `_sipfederationtls._tcp.domain.com` that points to the FQDN of the Meeting Server. This step is required as Call Bridge will need to have a public IP, and NAT is not supported in this scenario.

2. Add a DNS A record that resolves the FQDN of the Meeting Server to a public IP address.
3. Upload a certificate and certificate bundle to the Meeting Server that complies with the following:
 - a. The certificate must have the FQDN as the CN, or if using a certificate with a SAN list then ensure that the FQDN is also in the SAN list. Note: if the certificate contains a SAN list, then Lync will ignore the CN field and only use the SAN list.
 - b. The certificate must be signed by a public CA.

Note: you are advised to use the same Certificate Authority (CA) that is trusted by Lync FE servers. Contact your Lync adviser for details of the CA and for support on the Meeting Server-Lync integration.

- c. The certificate bundle must contain the Root CA's certificate and all intermediate certificates in the chain in sequence, so that a chain of trust can be established.

Note: for more information on certificates refer to the Introduction in the [Cisco Meeting Server Certificate Guidelines](#).

- d. Open the appropriate Firewall ports as stated in [Appendix B](#) for example: TCP 5061, UDP 3478, UDP 32768-65535, TCP 32768-65535

For outbound calls from the Meeting Server:

1. Create an outbound dial rule, leave the **Domain** and **SIP proxy** fields blank, and set **Trunk** type as Lync. Also set the appropriate **Local contact domain** and the **Local from domain** fields.

If specifying individual domains in outbound dial plan rules, ensure that all domains configured on the Lync side have been added. The domains in use can be read from the Lync Server Topology Builder. Note that if additional domains are later added to Lync, then these should also be added to the outbound dial plan rules.

8.7 Calling into scheduled Lync meetings directly and via IVR

Pre-requisite on Lync deployment: This feature requires a working Lync deployment with telephone dial-in capabilities already enabled. The Lync deployment requires one or more on-prem Lync FE servers to be configured.

Note: The on-prem Lync FE servers need to be configured even if your Lync deployment does not support external Lync or Skype for Business clients.

The Meeting Server supports calling into a scheduled Lync meeting from WebRTC or SIP endpoint, using the Lync call ID to join the call; Cisco Meeting App users can only be added to a Lync meeting by a Lync client. This feature requires one or more Lync FE servers to be configured on the Meeting Server for conference lookup. You can configure one via the Web Admin interface under the Lync Edge settings from **Configuration > General**, and one or more via the API (create them as TURN servers with type " lyncEdge"). Refer to [Configuration on Meeting Server to use Lync Edge](#) for instructions on how to do this. If there are multiple FE servers in a Pool, use the Pool FQDN as the Server Address.

Note: For Lync meeting resolution, the Meeting Server uses the Lync meeting ID and DNS lookup of `_sipinternaltls._tcp.lync-domain`, rather than outbound rules. Set DNS SRV record `_sipinternaltls._tcp.lync-domain` on your DNS server or if you do not want to use a DNS SRV record then setup a record on the Meeting Server with the command `dns app add rr <DNS RR>`. For more information on using the dns app command see the [MMP Command Line Reference](#); for a list of DNS records needed for the combined type deployment see [Appendix](#).

Configure the Lync FE servers, then follow the task sequence in Table 6 below:

Table 6: Task sequence to configure Lync FE servers

Sequence	Task	On the Web Admin Interface	Via the API
1	Configure the Call Bridge IVR(s) to allow entry of Lync conference IDs	If you have set up an IVR via the Web Admin Interface: Go to Configuration > General in the IVR section, set Joining scheduled Lync conferences by ID to allowed	If you have set up IVRs through the API: Set resolveLyncConferenceIds to true for the configured IVR
2	Allow direct dialing to Lync conference IDs from standard SIP systems. Note: you may choose to extend an existing configured domain to allow Lync conference access, or to create a new one for this purpose.	Go to Configuration > Incoming calls , and for one or more configured call matching domains, set Targets Lync to yes	Set resolveToLyncConferences to true on the incoming dial plan rule
3	Allow Lync conference ID entry via the Web Bridge call join interface	If you have set up the Web Bridge via the Web Admin Interface: Go to Configuration > General in the Web bridge settings section ensure that Joining scheduled Lync conferences by ID is set to allowed	If you have set up Web Bridges through the API: Set resolveLyncConferenceIds to true on the Web Bridge

If a call is being matched against Lync conference IDs, the Call Bridge first checks that the call ID does not apply to a space, if it does not then the Call Bridge identifies a Lync FE server that it has been configured with, that has advertised itself as having the capability to resolve IDs. The

Call Bridge queries the Lync FE server to determine whether the call ID in question corresponds to a Lync conference – if it does, the look up is deemed to have been successful and the call is joined to the Lync call. If the call ID is not recognized as corresponding to a Lync conference then no further Lync FE servers will be queried.

Note: You may get unexpected results if you add the settings of multiple Lync FE servers that are in different Lync deployments. For instance, if multiple Lync conferences in different Lync deployments use the same call ID, then more than one Lync FE server may respond positively to the lookup, in which case the "first" successful Lync resolution is used.

Note: Each participant connecting through a Meeting Server to a Lync meeting is required to have a unique "from:" SIP address to avoid participant conflicts in the Lync AVMCU. Telephone participants connecting through a PSTN gateway are at a high risk of encountering participant conflicts due to the generic outgoing callerID information. It is recommended that all telephone participants connect to Lync meetings through the Lync PSTN Conferencing/Mediation Server rather than through the Meeting Server Dual Home gateway.

The text in the invitations sent for scheduled Lync meetings can be customized to include the necessary details to allow users to join via the Meeting Server. These details should be placed in the custom footer section. For example **'For SIP/H.323 endpoints, join by calling join@example.com and entering the conference ID above. For WebRTC go to join.example.com and enter the conference ID above.'** The URIs in this must match those configured above. Please see the Microsoft documentation <https://technet.microsoft.com/en-us/library/gg398638.aspx> for more details.

8.8 Choosing Call Bridge mode to connect participants to Lync conferences

You can choose the behavior of the Call Bridge when connecting participants to Lync conferences, using the Meeting Server API. A request parameter `lyncConferenceMode` has been added when POSTing to `/callProfiles` or PUTing to `/callProfile/<call profile id>`.

Set to `dualHomeCallBridge` if you want the calls on the same Call Bridge to be combined into one conference. This will result in a single conference on the Call Bridge, the Call Bridge will call out to the AVMCU meeting.

Set to `gateway` if you do not want the calls to be combined into one conference. Each SIP participant will be in their own conference with an associated call out to the AVMCU meeting.

Note: Set `lyncConferenceMode` to `gateway` to disable dual home conferencing.

9 Office 365 Dual Homed Experience with OBTP Scheduling

9.1 Overview

“Office 365 Dual Homed Experience with OBTP (One Button To Push) Scheduling” allows participants to join Office 365 meetings using Cisco endpoints that support OBTP.

The host schedules a meeting using Microsoft Outlook with Skype for Business plugin, and adds participants and conference rooms (including OBTP-enabled endpoints) and a location to meet in.

To join the meeting, participants using a OBTP-enabled endpoint simply push the OBTP button on the endpoint or touchscreen. Skype for Business clients click a link to join the meeting as normal.

Note: If using Office 365, only invited OBTP-enabled endpoints or Skype for Business clients with Office 365 can join the Lync meeting; Cisco endpoints cannot join the meeting manually, via the Meeting Server IVR. This is a key difference to an on-premise Lync deployment, which allows any Cisco endpoint to join manually via the Meeting Server IVR.

Note: “Office 365 Dual Homed Experience with OBTP (One Button To Push) Scheduling” is supported from Version 2.2, and requires Cisco TMS 15.5, and Cisco TMS XE 5.5 or later.

9.2 Configuration

Note: This feature requires the Call Bridge to connect to the public internet in order to contact Office 365. You will need to open TCP port 443 on your firewall for outgoing traffic.

To set up this method of joining Office 365 meetings, sign into the Web Admin interface of the Meeting Server, navigate to **Configuration>Incoming calls** and configure a **Call matching** rule for incoming calls with the **Targets Lync Simplejoin** field set to `true`. This tells the Meeting Server how to resolve the Lync Simple Meet URL sent in the Office 365 invite.

To have the ability to call participants as well as meetings, use an existing outbound dial plan rule to route the outbound calls, or create a new outbound dial plan rule.

9.3 In-conference experience

"Office 365 Dual Homed Experience with OBTP Scheduling" provides the "dual homed experience" with 2-way audio, video and content sharing. Office 365 clients have the familiar in-conference experience determined by the Lync AVMCU, and participants using OBTP enabled endpoints have a video conferencing experience determined by the Meeting Server. All see the combined participants lists.

Note: Controls on clients do not work conference wide, and can give rise to some strange behavior. For example, if a Skype for Business client mutes an endpoint connected to the Meeting Server then the endpoint will mute, but no notification is sent to the endpoint to say it has been muted; the endpoint cannot unmute itself. If a Skype for Business client mutes all endpoints connected to the Meeting Server and then unmutes them, all the endpoints will remain muted.

Note: ActiveControl functionality such as muting and dropping participants only affect participants on the local Call Bridge and not on the Lync AVMCU.

10 Settings for Web Bridge 3

This section explains how to configure the settings through which the Call Bridge communicates with Web Bridge 3. This allows you to use web app video calls and meetings.

If you are testing the web app, follow the instructions in [Section 10.2](#) in the order provided at any time after the initial Meeting Server configuration has been completed. If you are not using web app, skip this chapter.

Note: If your deployment requires the Cisco Expressway Web Proxy to connect to the Web Bridge, then ensure the SAN field of the Web Bridge certificate includes the A record used by the Expressway-C that will connect to the Web Bridge, otherwise the connection will fail. For example, if the Expressway is configured to connect to the Web Bridge on join.example.com, an A record must exist for this FQDN, and the SAN field of the Web Bridge certificate must include join.example.com.

10.1 Web Bridge 3 connections

Table 7 show the ports used for web app connections. [Section 10.1.1](#) describes the call flow between the web app and components in the Meeting Server.

Figure 16: web app port usage

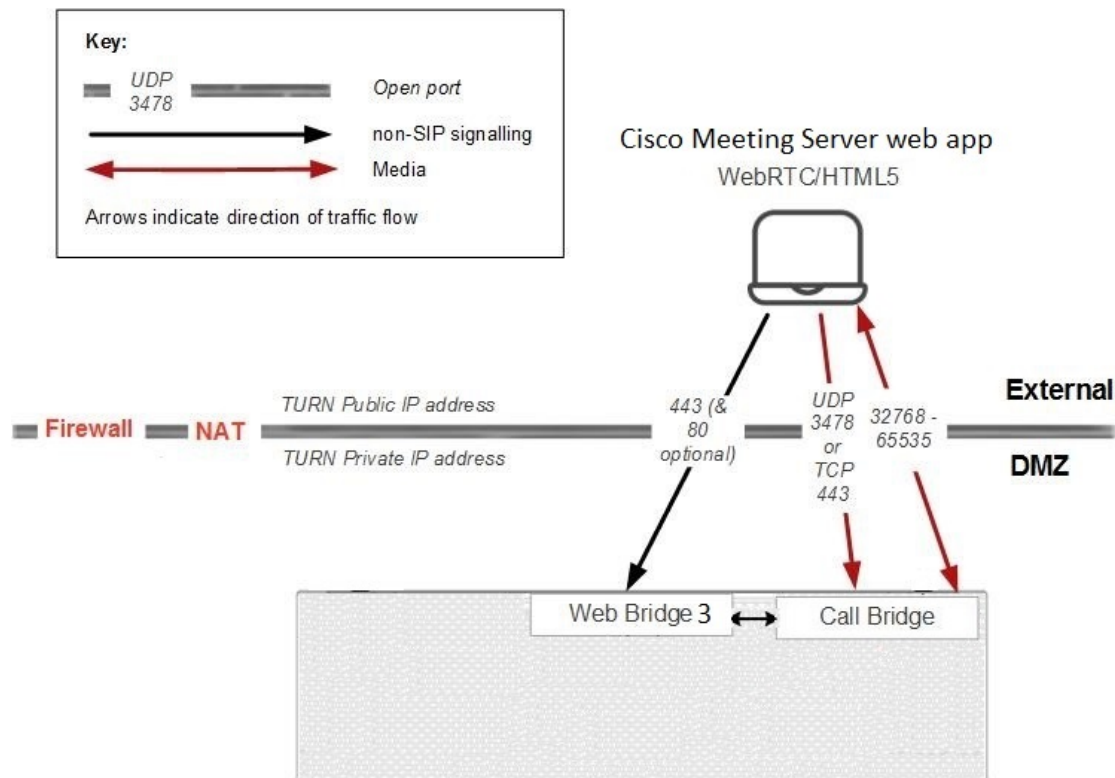

Table 7: Ports required for web app connections

Component	Connecting to	Destination port to open	Traffic type	Traffic direction with respect to component	Additional information
Web Bridge 3	web app	443 (Note 1)	TCP (HTTPS)	Incoming	
Web Bridge 3	web app	80	TCP (HTTP)	Incoming	
Call Bridge	Web Bridge 3				Internal to Meeting Server, does not require open ports

Note 1: Destination port should be what is configured for Web Bridge 3 https listening port.

10.1.1 Web Bridge 3 call flow

This section describes the call flow between the web app and components in the Meeting Server.

1. The web browser opens an HTTPS connection.
2. User is prompted to **Join meeting** (see step 3) or **Sign in** (see step 4)
3. If **Join meeting** is selected, user is prompted to enter the Call ID/URI and passcode and set their name.
 - a. Call details are sent over HTTPS to Web bridge 3; Web Bridge 3 queries the Call Bridge over the C2W connection to validate call details.
 - b. If successful, the user is asked to pick media settings.
 - c. After choosing media settings, the call details and desired name are sent over HTTPS to the Web Bridge 3; forwarded over C2W to the Call Bridge. Call Bridge will respond with a call access token which is returned to the browser and details the TURN servers to be used by the browser.
 - d. Call Bridge requests allocations from its configured TURN server.
 - e. Web app requests allocations from the provided TURN server.
 - f. The browser opens a websocket connection to the Web Bridge 3, which is forwarded over C2W connection to the Call Bridge. The call access token is sent over this websocket.
 - g. The browser and Call Bridge exchange SDP over websocket containing local media IP address/ports as well as media relay address/ports.
 - h. ICE negotiation sends UDP packets between all browser media IP address/port combinations and all Call Bridge address/port combinations; attempts TCP

connections to TCP media relay address/ports.

- i. Shortest successful media path is used for transmitting media between the browser and Call Bridge, either directly, through a TURN UDP relay, or through a TURN TCP relay (with the TURN server translating media packets between TCP stream and UDP)
4. If **Sign in** is selected, user is prompted to enter Username and Password.
- a. Sent over HTTPS to web bridge, which is forwarded to call bridge to obtain an portal access token if successful.
 - b. Enters user portal, all requests are made over HTTPS sending portal access token as header.
 - c. If a join call request is made, the flow is the same as above from step 3c onwards, except instead of sending call details and desired name to obtain a call access token, the browser instead sends call details and portal access token.

Useful information: call access tokens and portal access tokens are different, although similar. The portal access token is valid for 24 hours and allows a user to access the user portal. The call access token is only valid for the duration of a user's participation in the call, and is used only to join a call. The only way to obtain a portal access token is by signing in with a user name and password. A call access token can be obtained either by doing a guest join, or by using the portal access token along with the details of the meeting the user wants to join

10.2 Web Bridge 3 settings

Version 3.0 onwards allows you to configure Web Bridge configuration options in a common place rather than solely on a per Web Bridge basis – you can apply the same settings for all, or a specified group of Web Bridges.

The `/webBridgeProfiles` API object contains the various Web Bridge configuration options. A newly defined Web Bridge profile can be assigned to the individual `webBridge` objects, or to the top level (global) profile or tenants.

See the section on Web Bridge and Web Bridge Profile Methods in the [API Reference Guide](#) for further details on configuring the Web Bridge 3.

10.2.1 How to create and apply a web bridge profile example

Before you begin, ensure that you have installed the Web Bridge 3 certificate and configured the Web Bridge 3 as detailed in [Section 4.6](#). Then follow these steps:

1. To create a `webBridgeProfile` using the Meeting Server Web Admin interface:
 - a. Log in to the Meeting Server Web Admin interface and select **Configuration > API**:
 - b. From the list of API objects, tap the ► after `/api/v1/webBridgeProfiles`

- c. Click **Create new**.
 - d. Set the **name** field to the name you wish to call this web bridge profile.
 - e. Set the **resourceArchive** field to the address of any customization archive file that the Meeting Server should use for web bridges using this web bridge profile.
 - f. Set the **allowPasscodes** field to either **true** or **false**. This field determines whether or not web bridges using this web bridge profile should allow users to lookup coSpaces (and coSpace access methods) with passcodes in combination with a numeric ID/URI. If this parameter is not supplied, it defaults to **true**.
 - g. Set the **allowSecrets** field to either **true** or **false**. This field determines whether or not web bridges using this web bridge profile should allow users to access coSpaces (and coSpace access methods) through a meeting join link with a numeric ID and secret. If this parameter is not supplied, it defaults to **true**.
 - h. Set the **userPortalEnabled** field to either **true** or **false**. This field determines whether or not web bridges using this web bridge profile should display the sign-in tab on the index page. If this parameter is not supplied, it defaults to **true**.
 - i. Set the **allowUnauthenticatedGuests** field to either **true** or **false**. If set to **true**, guest access is allowed from the landing screen on web bridges using this web bridge profile. If set to **false**, visitor access is only allowed once users have logged into the User Portal. If this parameter is not supplied, it defaults to **true**.
 - j. Set the **resolveCoSpaceCallIds** field to either **true** or **false**. This field determines whether or not web bridges using this web bridge profile should accept coSpace and coSpace access method call IDs for the purpose of allowing visitors to join cospace meetings. If this parameter is not supplied, it defaults to **true**.
 - k. Set the **resolveCoSpaceUris** field to either **off**, **domainSuggestionDisabled** or **domainSuggestionEnabled**. This field determines whether or not this web bridge should accept coSpace and coSpace access method SIP URIs for the purpose of allowing visitors to join cospace meetings. When set to **off**, join by URI is disabled; when set to **domainSuggestionDisabled**, join by URI is enabled but the domain of the URI won't be auto-completed or verified on this web bridge; when set to **domainSuggestionEnabled** join by URI is enabled and the domain of the URI can be auto-completed and verified on this web bridge. If this parameter is not supplied, it defaults to **off**.
 - l. Click **Create**.
2. Once you've created the profile, you can then add addresses – this is the Web Bridge URI used to generate meeting invites and the cross launch URL for the web app.

Note: From version 3.1 you can also now specify multiple IVR numbers and Web Bridge addresses – up to 32 IVR numbers and up to 32 Web Bridge addresses per Web Bridge profile. These are used when displaying join information, and for generating email invitations.

In this example a Web Bridge URI and IVR telephone number are applied to a webBridgeProfile as follows:

- a. From the list of API objects tap the ► after `/api/v1/webBridgeProfiles`
- b. Click **View or edit**
- c. From the resulting "webBridgeProfile object selector window", click **Select** for the **object id** of the **webBridgeProfile** that you have created in Step 1 that you wish to assign a Web Bridge URI and IVR number to. Enter the **label** and URL **address** for the Web Bridge, and enter the **label** and **number** for the IVR as required.

« return to object list

`/api/v1/webBridgeProfiles/410c2b53-3135-4f58-8742-08e5b025675a/webBridgeAddresses`

Related objects: [/api/v1/webBridgeProfiles](#)
[/api/v1/webBridgeProfiles/410c2b53-3135-4f58-8742-08e5b025675a](#)

« start < prev **1 - 1** (of 1) next » Table view XML view

object id	label
b4311cfb-6071-4fe9-b684-f55c197e4681	Pre-A

`/api/v1/webBridgeProfiles/410c2b53-3135-4f58-8742-08e5b025675a/webBridgeAddresses`

label

address (URL)

« return to object list

`/api/v1/webBridgeProfiles/410c2b53-3135-4f58-8742-08e5b025675a/ivrNumbers`

Related objects: [/api/v1/webBridgeProfiles](#)
[/api/v1/webBridgeProfiles/410c2b53-3135-4f58-8742-08e5b025675a](#)

« start < prev **none** next » Table view XML view

```
<?xml version="1.0"?>
<ivrNumbers total="0"></ivrNumbers>
```

`/api/v1/webBridgeProfiles/410c2b53-3135-4f58-8742-08e5b025675a/ivrNumbers`

label

number

- d. Click **Create**.

3. Assign the ID of the newly created webBridgeProfile to any or all of the following, as required:
 - Top level (global) profile (`/api/v1/system/profiles`)
 - Tenants (`/api/v1/tenants/<id>`)
 - WebBridges (`/api/v1/webBridges/<id>`)

In this example an updated webBridgeProfile is assigned to the top level (global) profile as follows:

- a. From the list of API objects tap the ► after `/api/v1/system/profiles`
- b. Click **View or edit**
- c. Scroll down the parameters to **webBridgeProfile** and click **Choose**.
- d. From the resulting " webBridgeProfile object selector window" , click **Select** for the **object id** of the **webBridgeProfile** that you have created in Step 1 that you wish to assign to the top level global profile.
- e. Click **Modify**.
- f. The newly assigned webBridgeProfile object id should now be listed under **Object configuration**.

Note: For more information on the web app, see [Cisco Meeting Server web app Important Information](#).

11 Recording and Streaming meetings

Prior to 3.0, Meeting Server's internal recorder and streamer components were dependent upon the Meeting Server's internal XMPP server component – in 3.0 this XMPP server is removed. Version 3.0 introduces a new internal recorder and streamer, both SIP-based.

The new internal recorder and streamer components and dialing out to third-party SIP recorders are all configured using SIP URIs, so when recording or streaming is started the administrator-configured SIP URI is called.

11.1 Feature benefits of the new internal SIP recorder and streamer

- The new recorder and streamer support changing layouts. The recorder/streamer get its layout in a similar way to other SIP calls, i.e. from the defaultLayout parameter on the callLegProfile hierarchy or coSpace object. You can also change the layout parameter in the callLeg.
- Custom layouts can be set using the layoutTemplate parameter (you will need a customizations license to implement custom layouts).
- You can control the maximum resolution on a per callLeg basis using the qualityMain parameter in callLegProfiles and callLegs.
- Previously the XMPP streamer only supported 720p resolution, however the new streamer supports up to 1080p resolution and 3.0 allows you to select the streamer resolution using the MMP command `streamer sip resolution`.
- You can choose whether the streamer/recorder receives presentation by changing the presentationViewingAllowed parameter setting in the callLegProfile.
- Improved scalability with the introduction of the new MMP command `recorder limit` and `streamer limit`.

11.2 Points to note when implementing the new internal SIP recorder and streamer

Note: The new internal SIP recorder and streamer service cannot be used as an External recording or streaming service as the services rely on specific SIP header parameters passed by the Meeting Server Call Bridge. When calls from any other source that is not Meeting Server Call Bridge connect, the recorder/streamer will reject the call as it won't locate the specific SIP headers expected.

The recommended deployment for production usage of the recorder is to run it on a dedicated VM with a minimum of 4 vCPU cores and 4GB of RAM. The following table provides an idea of performance and resource usage for each of the recording types.

Table 8: Internal SIP recorder performance and resource usage

Recording Setting	Recordings per vCPU	RAM required per recording	Disk budget per hour	Maximum concurrent recording
720p	2	0.5GB	1GB	40
1080p	1	1GB	2GB	20
audio	16	100MB	150MB	100

Key point to note (applies to new internal recorder component only):

- Performance scales linearly adding vCPUs up to the number of host physical cores.

The recommended deployment for production usage of the streamer is to run it on a dedicated VM with a minimum of 4 vCPU cores and 4GB of RAM. The following table gives an idea of 3 recommended minimum specifications and the number of streams they can handle.

Table 9: Internal SIP streamer recommended specifications

Number of vCPUs	RAM	Number of 720p streams	Number of 1080p streams	Number of audio-only streams
4	4GB	50	37	100
4	8GB	100	75	200
8	8GB	200	150	200

Key points to note (applies to new internal streamer component only):

- Number of vCPUs should not oversubscribe the number of physical cores.
- Maximum number of 720p streams supported is 200 regardless of adding more vCPUs.
- Maximum number of 1080p streams supported is 150 regardless of adding more vCPUs.
- Maximum number of audio-only streams supported is 200 regardless of adding more vCPUs.

11.3 Recording overview

There are two methods of recording meetings when using Meeting Server:

- [Third-party external SIP recorder](#)
- [Meeting Server internal SIP recorder component](#)

11.3.1 Third-party external SIP recorder support

Meeting Server allows configuration of a third-party external SIP recorder so that when recording is started an administrator-configured SIP URI is called in the same way as the new Meeting Server internal SIP recorder component.

Note: Support for an external third-party SIP recorder still requires Meeting Server recording licenses.

The third-party external SIP recorder feature:

- allows recorders to negotiate BFCP in order to receive separate video and content streams. This gives more flexible options for how recordings are formatted.
- supports the same resolutions as we do for standard SIP calls
- supports the same audio and video codecs as standard SIP calls
- as with the existing Meeting Server internal recorder, any media content sent by the SIP recorder is discarded.

Note: The SIP recorder feature does not support TIP or Active Control.

11.3.2 Meeting Server internal SIP recorder component support

The internal SIP Recorder component (from version 3.0) on the Meeting Server adds the capability of recording meetings and saving the recordings to a document storage such as a network file system (NFS).

The Recorder should be enabled on a different Meeting Server to the server hosting the conferences, see Figure 17. Only locate the Recorder on the same Meeting Server as the Call Bridge which is hosting the conferences (local) for the purposes of testing the deployment.

Where possible it is recommended that the Recorder is deployed in the same physical locality as the target file system to ensure low latency and high network bandwidth. It is expected that the NFS is located within a secure network.

Note: Depending on the mechanism you use to store the recordings you may need to open external firewall ports so that the recorder, uploader and storage system can communicate. For example: NFS running version 2 or 3 of the port mapper protocol uses TCP or UDP ports 2049 and 111.

Note: Do not use the Firewall component on the Meeting Server if using either the Recorder or Uploader.

Note: At the end of recording a meeting, the recording is automatically converted to MP4. The converted file is suitable for placing within a document storage/distribution system, for example, in a network file system (NFS) they are stored in the NFS folder spaces/<space ID>; tenant spaces are stored in tenants/<tenant ID>/spaces/<space ID>.

The following figures show the various permitted recording deployments.

Figure 17: Permitted deployment for recording: remote mode

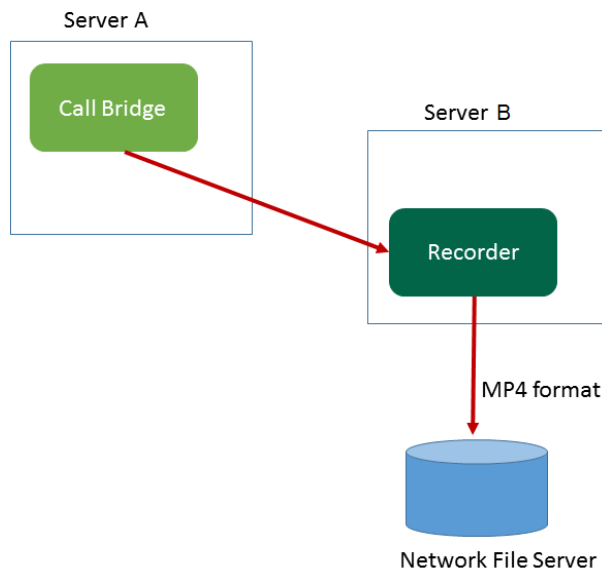
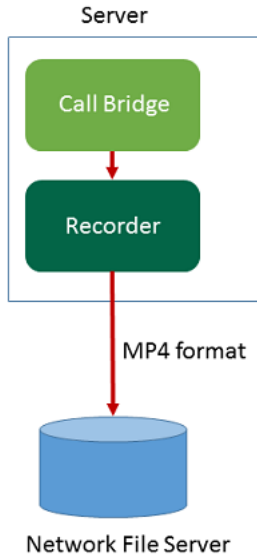

Figure 18: Permitted deployment for testing purposes only: local mode



11.4 Example of deploying the new internal SIP recorder component on a VM server

Note: If you plan to save the recordings on a NFS server running Windows 2008 R2 SP1, there is a windows hotfix required to fix permission issues: <https://support.microsoft.com/en-us/kb/2485529>. Consult your Microsoft Windows Administrator before applying this fix.

This is a two stage process:

- [Configuring a Meeting Server recorder via the MMP](#)
- [Configuring the recorder URI via the API](#)

Task 1: Configuring a Meeting Server recorder via the MMP

1. Upgrade to version 3.0.
2. SSH into the MMP and login to configure the recorder (enter the MMP command, `recorder` to see a list of all available commands).
3. Enter `recorder nfs <hostname/IP>:<directory>` to configure the NFS location.
4. Enter `recorder resolution <audio|720p|1080p>` to configure the desired resolution (or to only record the audio of calls).

5. Configure the listening interface of the recorder and the SIP TCP and TLS ports to listen on using the MMP command `recorder sip listen <interface> <tcp-port|none> <tls-port|none>`. Set the respective port to `none` to disable the service:
 - a. For example, if you want to only listen on the TLS port and not the TCP port, enter `recorder sip listen a none 6000`
 - b. Make a note of the ports you've configured if they're not the default TCP/TLS ports (5060/5061) as they will be needed later.

Note: If you want to listen on the default SIP TCP/TLS ports (5060/5061) you MUST ensure that the Call Bridge is not listening on the same interface, otherwise the ports will clash. You must disable the Call Bridge by removing the corresponding interface, by entering the MMP command `callbridge listen none`.

6. Optionally, if TLS is configured, configure the SIP TLS certificates you would like to use:
 - a. Enter the MMP command `recorder sip certs <key-file> <cert-file> [<cert-bundle>]`

Note: Note that if SIP TLS certificates are not configured with this option, the SIP TLS service will fail to start.

7. Optionally, if TLS is configured, you can perform TLS verification for SIP on the recorder as follows:
 - a. Enter the MMP command `tls sip trust [<cert-bundle>]`
 - b. Enter the MMP command `tls sip verify enable`

Note: For the TLS connection to be secure we recommend enabling TLS verification.

8. Check the configuration is correct – enter the MMP command `recorder` to view the configuration.
9. Enter the MMP command `recorder enable` to enable the recorder service.

Task 2: Configuring the recorder URI via the API

Once the new SIP recorder is enabled, it can be configured and used in the Call Bridge in the same way as a third-party SIP recorder, using the `sipRecorderUri` API parameter specified in the API call profile object.

If you wish, you can also configure a custom URI that maps to an outboundDialPlan rule (the domain can be anything of your choice, e.g. "recording.com"). You will need to configure an outboundDialPlan rule which tells Meeting Server how to route the domain used in `sipRecorderUri` to the recorder. This will allow you to control priority values, encryption, etc. For more information on configuring outboundDialPlan rules, see the "Dial plan configuration – overview" chapter.

Note: The user part of the configured URI (i.e. the part before the '@' symbol) has no special meaning, and for the new internal SIP recorder component, although required, it can usually be anything, e.g. "recording@recorder.com". However, this may not be the case for third-party SIP recorders which may use the user part of the URI for user credentials, for example. The important part of the URI is the domain part.

To configure the `sipRecorderUri` parameter using the Meeting Server Web Admin interface:

1. Log in to the Meeting Server Web Admin interface and select **Configuration > API**:
2. From the list of API objects, tap the ► after `/api/v1/callProfiles`
3. To configure or modify an existing call profile, select the object id of the required callProfile and fill in the `sipRecorderUri` field with your chosen URI.

Note: When using the new SIP recorder you only need to use one SIP URI, e.g recording@recorder.com, you don't need to have different SIP URIs on different profiles (it makes no difference).

4. If you haven't done so already, set the `recordingMode` field to either, **manual** or **automatic** (depending on how you want meetings to be recorded).
5. Click **Modify**.

The updated callProfile can then be assigned to coSpaces, tenants or the top level (global) profile, as required. In this example an updated callProfile is assigned at the global level as follows:

1. Using the Web Admin interface, select **Configuration > API**:
 - a. From the list of API objects tap the ► after `/api/v1/system/profiles`
 - b. Click **View or edit**
 - c. Scroll down the parameters to `callProfile` and click **Choose**.
 - d. From the resulting "callProfile object selector window", click **Select** for the **object id** of the `callProfile` you wish to assign to the top level global profile.
 - e. Click **Modify**.
 - f. The newly assigned callProfile object id should now be listed under **Object configuration**.

11.4.0.1 callProfile configuration example (if using a matching outbound dial plan rule):

In this example, `recordingMode` is set to **automatic** and `sipRecorderUri` to `recording@recorder.com` using the steps above.

Object configuration

```
recordingMode automatic
sipRecorderUri recording@recorder.com
```

From the Meeting Server Web Admin interface select **Configuration > Outbound calls** to see the matching outbound dial plan rule:

Domain	SIP proxy to use	Local contact domain	Local from domain	Trunk type	Behavior	Priority	Encryption	Tenant
recorder.com	10.209.131.45		<use local contact domain>	Standard SIP	Stop	0	Unencrypted	no
				Standard SIP ▼	Stop ▼	0	Auto ▼	[Add New] [Reset]

If you configured the recorder in the MMP to use SIP TCP/TLS ports which are different from the default standard ports (5060/5061), you MUST specify the listening port in the **sipRecorderUri** field or in the matching outbound dial plan rule if you are using one, as shown below:

Domain	SIP proxy to use	Local contact domain	Local from domain	Trunk type	Behavior	Priority	Encryption	Tenant
recorder.com	10.209.131.45:6000		<use local contact domain>	Standard SIP	Stop	0	Unencrypted	no
				Standard SIP ▼	Stop ▼	0	Auto ▼	[Add New] [Reset]

If using an outbound dial plan rule, make sure the service of the port specified matches the encryption type, for example, if using the SIP TLS port, set the **Encryption** mode to **Encrypted**.

11.5 Configuring an external third-party SIP recorder

- Specify the SIP recorder – use the sipRecorderUri API parameter for /callProfile objects. If set, this URI is used to dial out to when recording is enabled. If unset, the Meeting Server recorder component (if configured in /recorders) is used.
 - a. Use the Web Admin interface of the Meeting Server, select **Configuration>API**
 - b. From the list of API objects, tap the ► after **/callProfiles**
 - c. Either click on the **object id** of an existing call profile or create a new one
 - d. Set the **sipRecorderUri** parameter
- Use the recordingMode parameter on the API object /callProfiles or /callProfiles/<call profile id> to select whether a meeting can be recorded or not. Options for this are:
 - **automatic** – recording occurs without any user intervention, if recording cannot occur the meeting still occurs.
 - **manual** – users can manually start and stop the recording using DTMF.
 - **disabled** – no users can record.
- Control which users have permission to start and stop recording by setting the recordingControlAllowed parameter on callLegProfiles.

- Use the `startRecording` and `stopRecording` parameters for `/dtmfProfiles` and `/dtmfProfiles/<dtmf profile id>` to map the DTMF tones for starting and stopping recording.

Note: The additional API objects are given in the [Cisco Meeting Server API Reference guide](#).

11.6 Finding out recording status

To find out the recording status:

- Use the Web Admin interface of the Meeting Server, select **Configuration > API**
- From the list of API objects, tap the ► after `/callLegs`
- Click on the **object id** of an existing call leg

Perform a GET on `callLegs/<call leg id>` – the `recording` value in the `status` output found here indicates whether this callLeg is recording (`true`) or not (`false`).

11.7 Recording indicator for dual homed conferences

For dual homed conferences, recording should be done using the Microsoft recording method on the Lync/Skype endpoint. We do not recommend using Cisco Meeting Server to record dual homed conferences.

A recording icon indicates to SIP participants connected to the Meeting Server that a Lync/Skype endpoint is recording the conference on the Lync/Skype side.

Meeting Server adds a recording icon to the video pane composed for non-ActiveControl endpoints. Table 10 below shows the icons that Meeting Server will display to indicate that a dual homed conference is being recorded.

Table 10: Recording indicators

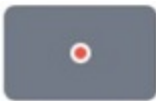
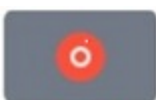
Icon displayed	Description
	Meeting is being recorded via the Meeting Server.
	Meeting is being recorded by a Lync/Skype endpoint
	Meeting is being recorded via the Meeting Server and by a Lync/Skype endpoint.
	The meeting is not being recorded (no icon displayed).

Note: web app shows the recording state using its own icons, they do not distinguish between local and remote recording. Meeting Server icons are not overlaid on the web app video pane.

11.8 Recording with Vbrick

Note: This section only applies to the Meeting Server internal Recorder component.

The Uploader component simplifies the work flow for uploading Meeting Server recordings to the video content manager, Vbrick, from a configured NFS connected to a Meeting Server. No manual importing of recordings is required.

Once the Uploader component is configured and enabled, recordings are pushed from the NFS to Vbrick, and an owner is assigned to the recording. The Rev portal applies security configured by your administrator to your video content, only allowing a user to access the content that they are permitted to access. Vbrick emails the owner when the recording is available in the owner's Rev portal. Owners of a recording access the video content through their Rev portal, and can edit and distribute as necessary.

Note: If a file is added to the NFS share within a space directory, the file will be uploaded to Vbrick as though it were a valid recording. Take care to apply permissions to your NFS share so that only the Recorder can write to it.

Note: Depending on the mechanism you use to store the recordings you may need to open external firewall ports so that the recorder, uploader and storage system can communicate. For

example: NFS running version 2 or 3 of the port mapper protocol uses TCP or UDP ports 2049 and 111.

Note: Do not use the Firewall component on the Meeting Server if using either the Recorder or Uploader.

11.8.1 Prerequisites for the Meeting Server

Uploader installation. The Uploader component can be installed on the same server as the Recorder component, or on a separate server. If installed on the same server as the Recorder, then add a couple of vCPUs for it to use. If run on a different server, then use the same server specification as for the Recorder: dedicated VM with a minimum of 4 physical cores and 4GB of RAM.

CAUTION: The Uploader must run on a different Meeting Server to the Call Bridge hosting the conferences.

Read and Write access to the NFS share. The Meeting Server running the Uploader will require Read and Write permissions for the NFS. Write permission is required to allow the Uploader to re-write the name of the mp4 file when upload is completed.

Note: If the NFS is set or becomes Read Only, then the Uploader component will continuously upload the same video recording to Vbrick. This is a result of the Uploader being unable to mark the file as upload complete. To avoid this, ensure that the NFS provides read/write access.

API Access to Vbrick Rev. Configure API access for a user on Vbrick Rev.

API Access to Call Bridge. Configure API access for a user on the Meeting Server running the Call Bridge.

Trust Store Store the certificate chains from the Vbrick Rev server, and the Meeting Server running the Web Admin interface for the Call Bridge. The Uploader needs to trust both the Vbrick Rev and the Call Bridge.

Decide who has access to the video recordings. Access to uploaded video recordings can be set to: All Users, Private, and for only space owners and members.

Default state of video recordings. Decide whether the video recordings are immediately available after upload (Active), or that the owner of the video recording needs to publish it to make the recording available (Inactive).

Table 11: Port Requirements

Component	Connecting to	Destination port to open
Call Bridge	NFS (version 3)	2049

Component	Connecting to	Destination port to open
Uploader	Web Admin of Call Bridge	443 or port specified in Uploader configuration
Uploader	Vbrick Rev server	443 for video uploads and API access to Vbrick Rev server

11.8.2 Configuring the Meeting Server to work with Vbrick

These steps assume that you have already setup the NFS to store recordings.

1. Establish an SSH connection to the MMP of the Meeting Server where you want to run the Uploader. Log in.
2. For new Vbrick installations, ignore this step. If you are reconfiguring a Vbrick installation then first disable Vbrick access to the Meeting Server.
`uploader disable`
3. Specify the NFS that the Uploader will monitor.
`uploader nfs <hostname/IP>:<directory>`
4. Specify the Meeting Server that the Uploader will query for recording information, for example the name of the Meeting Server hosting the space associated with the recording.
`uploader cms host <hostname>`
5. Specify the Web Admin port on the Meeting Server running the Call Bridge. If a port is not specified, it defaults to port 443.
`uploader cms port <port>`
6. Specify the user with API access on the Meeting Server running the Call Bridge. The password is entered separately.
`uploader cms user <username>`
7. Set the password for the user specified in step 6. Type
`uploader cms password`
you will be prompted for the password.
8. Create a certificate bundle (crt-bundle) holding a copy of the Root CA's certificate and all intermediate certificates in the chain for the Web Admin on the Meeting Server running the Call Bridge.
9. Add the certificate bundle created in step 8 to the Meeting Server trust store.
`uploader cms trust <crt-bundle>`
10. Configure the Vbrick host and the port to which the Uploader will connect.
`uploader rev host <hostname>`
`uploader rev port <port>`

Note: The port defaults to 443 unless otherwise specified.

11. Add a Vbrick Rev user who has API permission to upload video recordings.
`uploader rev user <username>`

12. Set the password for the user specified in step 11. Type
uploader rev password
 you will be prompted for the password.
13. Create a certificate bundle (crt-bundle) holding a copy of the Root CA's certificate and all intermediate certificates in the chain for the Vbrick Rev server.
14. Add the certificate bundle created in step 13 to the Vbrick Rev trust store.
uploader rev trust <crt-bundle>
15. Set access to the video recording.
uploader access <Private|Public|AllUsers>
16. Give members of the space the ability to view or edit the recordings.
uploader cospace_member_access <view|edit|none>

Note: This step requires the listed members to have valid email addresses which are associated with accounts on Vbrick. For example user1@example.com

17. Decide whether the owner of the space is the single owner of the video recordings.
uploader recording_owned_by_cospace_owner <true|false>

Note: This step also requires the owner of the video recordings to have a valid email address which is associated with an account on Vbrick.

18. If the owner of the space is not listed in Vbrick Rev, then set the username of the fallback owner. If the fallback owner is not specified, then owner will default to the user configured on the MMP.
uploader fallback_owner <vbrick-user>
19. Enable comments to the video recordings.
uploader comments enable
20. Enable ratings for the video recordings.
uploader ratings enable
21. Set the download permission for the video recordings.
uploader downloads enable
22. Set the default state of the video recording when first uploaded to Vbrick Rev.
uploader initial_state <active|inactive>
23. Decide whether to delete the video recording from the NFS after upload is complete
uploader delete_after_upload <true|false>
24. Enable the Uploader to access the Meeting Server
uploader enable

Note: Set **messageBoardEnabled** to **true** to see the messages being posted in the space indicating that the recording is available.

11.9 Streaming meetings

The internal SIP Streamer component (from version 3.0) adds the capability of streaming meetings held in a space to the RTMP URL configured on the space.

An external streaming server needs to be configured to be listening on this RTMP URL. The external streaming server can then offer live streaming to users, or it can record the live stream for later playback.

Note: The Streamer component supports the RTMP standard in order to work with third party streaming servers that also support the RTMP standard. Vbrick is the officially supported external streaming server, however, other servers have also been tested.

Note: The Streamer component supports the RTMP standard in order to work with third party streaming servers that also support the RTMP standard. Vbrick is the officially supported external streaming server, however, other servers have also been tested.

Note: You may need to open firewall ports if the streaming destination RTMP URLs are on the external side of a firewall.

Version 3.1 extends the RTMP support in the internal SIP streamer application to RTMPS – essentially RTMP over a TLS connection. Previously all traffic between the streamer and RTMP server was unencrypted, 3.1 RTMPS support allows this traffic to be encrypted.

The existing `rtmp` command is extended to optionally allow configuration of TLS trusts for RTMPS. This step is optional but recommended. If a TLS trust is not configured then the RTMPS connection will not be secure.

The following figure shows the permitted streamer deployment.

Figure 19: Permitted deployment for streaming: remote mode

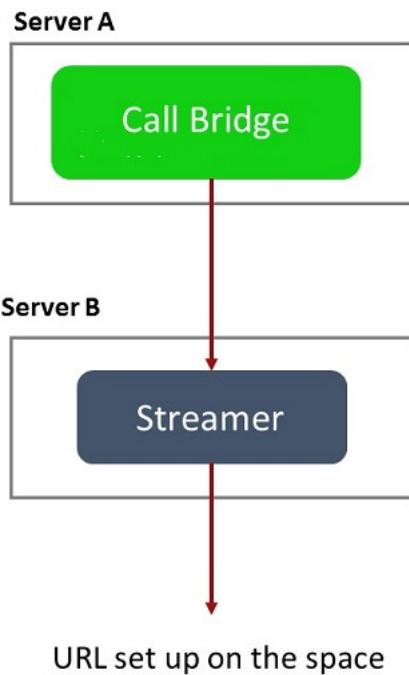

For testing purposes only, the Streamer can be co-located on the same server as the Call Bridge. This may support between 1 to 2 simultaneous streamings.

11.10 Deploying the new SIP streamer component on a VM server

This is a two stage process:

- [Configuring a Meeting Server streamer via the MMP](#)
- [Configuring the streamer URI via the API](#)

Task 1: Configuring a Meeting Server streamer via the MMP

1. Upgrade to version 3.0.
2. SSH into the MMP and login to configure the recorder (enter the MMP command, `streamer help` to see a list of all available commands).
3. Configure the listening interface of the streamer and the SIP TCP and TLS ports to listen on using the MMP command `streamer sip listen <interface> <tcp-port|none> <tls-port|none>`. Set the respective port to `none` to disable the service:
 - a. For example, if you want to only listen on the TLS port and not the TCP port, enter `streamer sip listen a none 6000`

- b. Make a note of the ports you've configured if they're not the default TCP/TLS ports (5060/5061), as they will be needed later.
4. Optionally, you can set the maximum resolution that you want the streamer to do (or to only stream the audio of calls) using the MMP command `streamer sip resolution <audio|720p|1080p>`, if not specified, the default is 720p.

- a. For example, if you want to set it to 1080p, enter `streamer sip resolution 1080p`

Note: If you want to use 1080p we recommend that you increase your transmit SIP call bandwidth to 3,500,000 bits per second to optimize the video quality. To do this, on the Web Admin UI go to **Configuration > Call settings > Bandwidth settings (SIP)** and set as required.

5. Optionally, if TLS is configured, configure the SIP TLS certificates you would like to use:
 - a. Enter the MMP command `streamer sip certs <key-file> <cert-file> [<cert-bundle>]`

Note: Note that if SIP TLS certificates are not configured with this option, the SIP TLS service will fail to start.

6. Optionally, if TLS is configured, you can perform TLS verification for SIP (or LDAP or RTMPS) on the streamer as follows, for example:
 - a. Enter the MMP command `tls sip trust [<cert-bundle>]`
 - b. Enter the MMP command `tls sip verify enable`

Note: For the TLS connection to be secure we recommend enabling TLS verification.

7. Check the configuration is correct – enter the MMP command `streamer` to view the configuration.
8. Enter the MMP command `streamer enable` to enable the streamer service.

Task 2: Configuring the streamer URI via the API

Once the new SIP streamer is enabled, it can be configured and used in the Call Bridge using the `sipStreamerUri` API parameter specified in the API call profile object.

If you wish, you can also configure a custom URI that maps to an `outboundDialPlan` rule (the domain can be anything of your choice, e.g. "streaming.com"). You will need to configure an `outboundDialPlan` rule which tells Meeting Server how to route the domain used in `sipStreamerUri` to the streamer. This will allow you to control priority values, encryption, etc. For more information on configuring `/outboundDialPlanRules`, see the "Dial plan configuration - overview" chapter of your [deployment guide](#).

Note: The user part of the configured URI (i.e. the part before the '@' symbol) has no special meaning, and for the new internal SIP streamer component, although required, it can usually be anything, e.g. "streaming@streamer.com". The important part of the URI is the domain part.

To configure the `sipStreamerUri` parameter using the Meeting Server Web Admin interface:

1. Log in to the Meeting Server Web Admin interface and select **Configuration > API**:
2. From the list of API objects, tap the ► after `/api/v1/callProfiles`
3. To configure or modify an existing call profile, select the object id of the required callProfile and fill in the `sipStreamerUri` field with your chosen URI.

Note: When using the new SIP streamer you only need to use one SIP URI, e.g. streaming@streamer.com, you don't need to have different SIP URIs on different profiles.

4. If you haven't done so already, set the `streamingMode` parameter to either, `manual` or `automatic` (depending on how you want meetings to be streamed).
5. Click **Modify**.

The updated callProfile can then be assigned to coSpaces, tenants or the top level (global) profile, as required. In this example an updated callProfile is assigned at the global level as follows:

1. Using the Web Admin interface, select **Configuration > API**:
 - a. From the list of API objects tap the ► after `/api/v1/system/profiles`
 - b. Click **View or edit**
 - c. Scroll down the parameters to `callProfile` and click **Choose**.
 - d. From the resulting "callProfile object selector window", click **Select** for the `object id` of the `callProfile` you wish to assign to the top level global profile.
 - e. Click **Modify**.
 - f. The newly assigned callProfile object id should now be listed under **Object configuration**.

For each coSpace in the API that you wish to enable streaming for, you must configure the `streamUrl` coSpace API field with the RTMPS stream URL to stream to (e.g. "rtmps://mystream.com/live/app"). To configure this:

1. Log in to the Meeting Server Web Admin interface and select **Configuration > API**:
2. From the list of API objects, tap the ► after `/api/v1/coSpaces`
3. To configure or modify an existing coSpace, select the object id of the required coSpace

and fill in the **streamUrl** field with the RTMPS stream URL to stream to.

4. Click **Modify**.

11.10.1 Known Limitations

CAUTION: Be warned that the stream URL is sent via SIP headers, so any RTMP stream URLs containing login credentials could potentially be exposed to call control providers which may log them.

12 Single Sign On (SSO) for Cisco Meeting Server web app

This feature allows a web app user to login using an SSO provider to verify their identity.

SSO means the web app user doesn't need to enter their password every time they sign in as they can now have a single session with an identity provider (the entity responsible for authenticating users at a single place and maintaining a single session for each, for example, OAuth, gmail).

It allows the web app user to login with different SSO providers on the same Web Bridge.

This SSO mechanism uses SAML (Security Assertion Markup Language) 2.0 which is an open standard and a widely used industry standard protocol.

Note: Currently Meeting Server supports only HTTP-POST bindings in the SAML 2.0 protocol. This means it will only accept messages on its HTTP-POST AssertionConsumerService and it will reject Identity Providers with no HTTP-POST bindings available

Note: If you enable SSO login, you can no longer use LDAP login.

12.1 Configuring SSO for use on Meeting Server web app

To use SSO requires some configuration for the identity provider and on the Meeting Server (regarded as the Service Provider in the SAML 2.0 exchange) as detailed below.

Task 1: Mapping between Identity provider and Meeting Server users

So that Meeting Server can correctly map users on your Identity provider to its own users you will need to setup an authenticationId for every user authenticated via SSO. This can be done as part of the standard ldap sync process. The contents of this field will be verified against a custom parameter passed from the Identity provider with successful responses (see Task 2).

We recommend that you choose a unique identifier for each user (e.g. \$sAMAccountName\$). Empty values for the authenticationIds are not accepted.

To setup the authenticationId as part of an ldapSync you can create a new ldapSync or modify an existing one.

You then need to create/modify an ldapMapping and populate the **authenticationIdMapping** parameter with an appropriate value (e.g. \$sAMAccountName\$).

Using the Meeting Server Web Admin interface:

- a. Log in to the Meeting Server Web Admin interface and select **Configuration > API**:
- b. From the list of API objects, tap the ► after **/api/v1/ldapMappings**
- c. Click **Create new** or select the ID for an existing ldap mapping to modify.

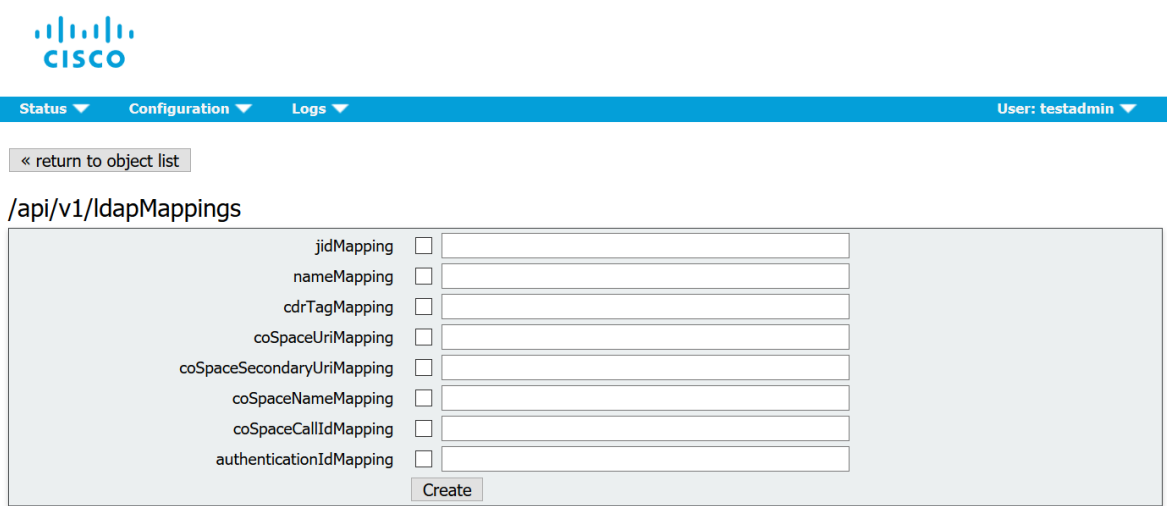

- d. Populate the **authenticationIdMapping** parameter with an appropriate value (e.g. \$sAMAccountName\$) and click **Create** or **Modify**, as appropriate.
- e. For the changes to take effect on the Meeting Server you now need to trigger an ldapSync. From the list of API objects, tap the ► after **/api/v1/ldapSyncs** and select the object ID or **Create new**, as appropriate. Once the ldapSync has finished you can verify that the process has succeeded by examining one of your Meeting Server users.
- f. Firstly, from the list of API objects, tap the ► after **/api/v1/users**, to display a list of users as seen in this example:

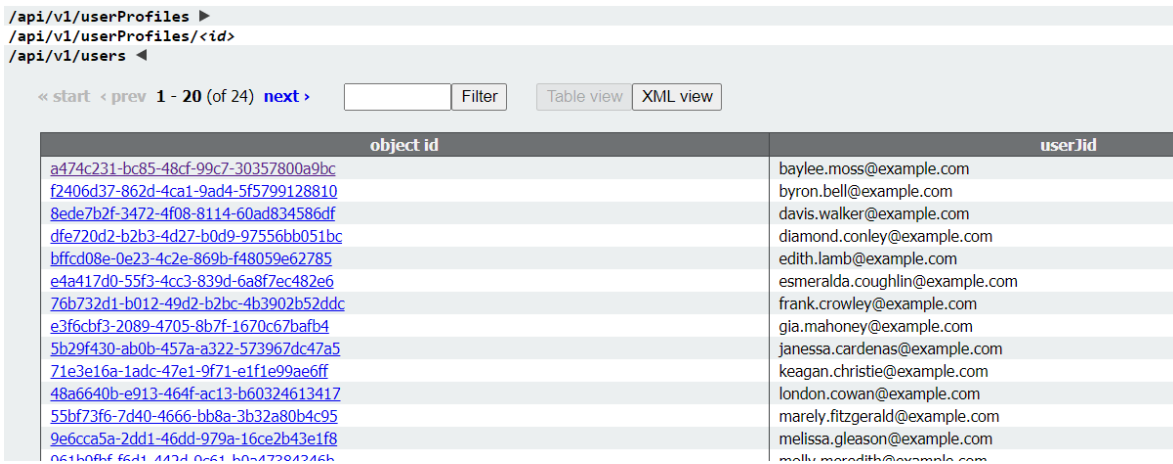

- g. Select one of the users that should now have authenticationId set up (you may need to use the Filter field). The user entry should now include an **authenticationId** field with the correct value from the ldapSync as shown in this example:

`/api/v1/users/a474c231-bc85-48cf-99c7-30357800a9bc`

Related objects: [/api/v1/users](#)

[/api/v1/users/a474c231-bc85-48cf-99c7-30357800a9bc/userCoSpaces](#)

[/api/v1/users/a474c231-bc85-48cf-99c7-30357800a9bc/userCoSpaceTemplates](#)

[/api/v1/users/a474c231-bc85-48cf-99c7-30357800a9bc/userProvisionedCoSpaces](#)

Table view XML view

Object configuration	
userJid	baylee.moss@example.com
name	Baylee Moss
email	baylee.moss@autotest.com
authenticationId	baylee.moss

Task 2: Identity Provider configuration

- All identity providers let you upload a metadata xml file representing the Service Provider being registered with them (i.e. the Meeting Server in this instance). Some identity providers simplify the process by allowing you to configure the most important pieces of information. Metadata xml file examples can be found [here](#).

The values to include in the metadata xml file to be uploaded to the identity provider are:

- entityID – this is the Web Bridge 3 address (i.e. `https://<domain>:port`). This address must be a valid Web Bridge 3 address reachable from the browsers of web app users.

Note: If there are multiple Web Bridge 3s in a deployment this should be a load-balanced address.

- An HTTP-POST AssertionConsumerService for the Web Bridge address defined as the entityId following the format `" https://<domain>:<port>/api/auth/sso/idpResponse"` .
- Optional. A public key for signing with which the identity provider will verify AuthnRequest signatures.
- Optional. A public key for encryption with which the identity provider will encrypt information sent back to one of the Web Bridge 3s routable through the address provided above.

Note: Meeting Server requires that messages sent to it are signed by the identity provider on the Response and/or Assertion level. Unsigned communication will be discarded.

2. You need to configure a custom parameter passed from your identity provider with a successful response. For each user its contents should match the value already configured as authenticationId for that Meeting Server user (e.g. \$sAMAccountName\$). Usually identity providers will have a special form or dialog for that as part of creating the Service Provider entry. This parameter can be any name of your choosing, although we recommend you choose something easy to remember, such as "uid" (you will need the name in [Task 3](#)).

Task 3: Creating SSO archive zip file

1. To configure the Meeting Server, you need to create an archive zip file named sso_<name>.zip for each SSO you want to configure for the Web Bridge 3 on that Meeting Server. The file name must start with "sso_" followed by a meaningful name of your choice.

Create a zip archive file containing these files:

- a. idp_config.xml – This is a file that the administrator will receive from the identity provider.
- b. config.json – includes:
 - supportedDomains (array of strings) – a list of all domains for Meeting Server users which will be authenticated against this identity provider. I.e. using the examples from [Task 1](#), supportedDomains would contain the single entry of "example.com".
 - authenticationIdMapping (string) – name of the parameter from the identity provider responses configured as part of [Task 2](#) (e.g. "uid") that matches to the authenticationIds in the Meeting Server. Web app users for SSO must have authenticationIds setup for them(see [Task 1](#).)
 - ssoServiceProviderAddress (string) – the address on which the identity providers will send the responses, this will match the Web Bridge 3 specified in the entityID in [Task 2](#).
- c. Optional. sso_sign.key – private key for the public signing key configured on the identity provider side. It will be used to sign outgoing AuthnRequests from Meeting Server which can then be verified using the public key on the identity provider's side.
- d. Optional. sso_encrypt.key – private key for the public encryption key configured on the identity provider side. It will be used to decrypt on the Meeting Server messages encrypted with the public key on the identity provider's side.

Note: You will need different named zip files for different identity providers.

2. Create an archive (zip) file containing the SSO files.

Note: When you zip the files, do not zip the folder containing the SSO files. If this is done, this will create an extra layer of folder (zipped file > folder > SSO files). Instead, highlight the SSO files and right-click to zip them (or open a zip application and zip the files together). This will create a zipped file with the SSO files without creating an extra layer of folder (e.g. zipped file > SSO files).

Task 4: Uploading the SSO archive zip

The SSO archive zip now needs to be uploaded and hosted on the local Web Bridge 3.

Note: The commands in the following steps are for console/terminal environments (i.e. command prompt or terminal) and not for SFTP clients such as WinSCP.

1. For each Meeting Server with an enabled Web Bridge 3 which will locally host this zip archive:
2.
 - a. Connect your SFTP client to the IP address of the MMP.
 - b. Log in using the credentials of the MMP admin user.
 - c. Upload the zip file `sso_<name>.zip`. For example:

```
PUT sso_<name>.zip
```
 - d. Connect your SSH client to the IP address of the MMP.
 - e. Log in using the credentials of the MMP admin user.
 - f. Restart the Web Bridge 3

```
webbridge3 restart
```
3. The new SSO archive file will be picked up after the restart.

Note: Once a web app user is logged in they will have a separate session on the web app application from the one with the identity provider. This means that if they logout/sign out from the web app application but not from the identity provider once they enter the same username they will automatically be allowed into the web app application again. However, if they sign out from the identity provider it doesn't sign them out from the web app application and they will have to also sign out from the web app application. To ensure that you cannot log in for this browser session again you must sign out from both the web app application and the identity provider.

12.1.1 Example 1 config.json file

This is an example config.json file:

```
{
  "authenticationIdMapping" : "<parameter_from_task_2>",
  "ssoServiceProviderAddress" : "https://<domain>:<port>",
  "supportedDomains" : [<domain1>,<domain2>"]
}
```

12.1.2 Example 2 Simple service provider metadata file.

This is an example simple service provider metadata file – note that administrators will have to modify <domain> and <port> with their relevant values.

```
<md:EntityDescriptor xmlns:md="urn:oasis:names:tc:SAML:2.0:metadata"
ID="https://<domain>:<port>" entityID="https://<domain>:<port>">
  <md:SPSSODescriptor AuthnRequestsSigned="false" WantAssertionsSigned="true"
protocolSupportEnumeration="urn:oasis:names:tc:SAML:2.0:protocol">
    <md:NameIDFormat>urn:oasis:names:tc:SAML:2.0:nameid-
format:transient</md:NameIDFormat>
    <md:AssertionConsumerService
Binding="urn:oasis:names:tc:SAML:2.0:bindings:HTTP-POST"
Location="https://<domain>:<port>/api/auth/sso/idpResponse" index="0"/>
  </md:SPSSODescriptor>
</md:EntityDescriptor>
```

12.1.3 Example 3 Comprehensive service provider metadata file.

This is a comprehensive metadata file example which includes an xml for the signing and encryption keys.

Note: The keys should be placed in the X509Certificate sub-elements of their corresponding KeyDescriptor elements according to the use parameter (" encryption" or " signing"). You must substitute " ..." with the text contents of the key (e.g. ds:X509CertificateMIID**<omitted_key_text>**+gb</ds:X509Certificate>)

Note: If you include a signing certificate, the value AuthnRequestsSigned is set to " true" (it is set to " false" in the simpler metadata file in example 2).

```
<md:EntityDescriptor xmlns:md="urn:oasis:names:tc:SAML:2.0:metadata"
ID="https://<domain>:<port>" entityID="https://<domain>:<port>">
  <md:SPSSODescriptor AuthnRequestsSigned="true" WantAssertionsSigned="true"
protocolSupportEnumeration="urn:oasis:names:tc:SAML:2.0:protocol">
    <md:KeyDescriptor use="signing">
      <ds:KeyInfo xmlns:ds="http://www.w3.org/2000/09/xmldsig#">
        <ds:X509Data>
          <ds:X509Certificate>...</ds:X509Certificate>
        </ds:X509Data>
      </ds:KeyInfo>
    </md:KeyDescriptor>
    <md:KeyDescriptor use="encryption">
      <ds:KeyInfo xmlns:ds="http://www.w3.org/2000/09/xmldsig#">
        <ds:X509Data>
```

```
        <ds:X509Certificate>...</ds:X509Certificate>
    </ds:X509Data>
  </ds:KeyInfo>
</md:KeyDescriptor>
  <md:NameIDFormat>urn:oasis:names:tc:SAML:2.0:nameid-
format:transient</md:NameIDFormat>
  <md:AssertionConsumerService
Binding="urn:oasis:names:tc:SAML:2.0:bindings:HTTP-POST"
Location="https://<domain>:<port>/api/auth/sso/idpResponse" index="0"/>
  </md:SPSSODescriptor>
</md:EntityDescriptor>
```

13 Support for ActiveControl

The Meeting Server supports ActiveControl for hosted calls. For participants using a Cisco SX, MX or DX endpoint with CE 8.3+ software installed, ActiveControl allows the meeting participant to receive details of the meeting and perform a few administrative tasks during the meeting, using the endpoint interface.

13.1 ActiveControl on the Meeting Server

The Meeting Server supports sending the following meeting information to ActiveControl enabled endpoints:

- Participant list (also known as the roster list) so that you can see the names of the other people in the call and the total number of participants,
- indicator of audio activity for the currently speaking participant,
- indicator of which participant is currently presenting,
- Indicators telling whether the meeting is being recorded or streamed, and if there are any non-secure endpoints in the call,
- on screen message which will be displayed to all participants,

and supports these administrative tasks on ActiveControl enabled endpoints:

- select the layout to be used for the endpoint,
- disconnect other participants in the meeting.

13.2 Limitations

- If an ActiveControl enabled call traverses a Unified CM trunk with a Unified CM version lower than 9.1(2), the call may fail. ActiveControl should not be enabled on older Unified CM trunks (Unified CM 8.x or earlier).
- ActiveControl is a SIP only feature. H.323 interworking scenarios are not supported.

13.3 Overview on ActiveControl and the iX protocol

ActiveControl uses the iX protocol, which is advertised as an application line in the SIP Session Description Protocol (SDP). The Meeting Server automatically supports ActiveControl, but the feature can be disabled, see section [Section 13.4](#). In situations where the far end network is not known or is known to have devices that do not support the iX protocol, it may be safest to disable iX on SIP trunks between the Meeting Server and the other Call control or Video Conferencing devices. For instance:

- for connections to Unified CM 8.x or earlier systems the older Unified CM systems will reject calls from ActiveControl-enabled devices. To avoid these calls failing, leave iX disabled on any trunk towards the Unified CM 8.x device in the network. In cases where the 8.x device is reached via a SIP proxy, ensure that iX is disabled on the trunk towards that proxy.
- for connections to third-party networks. In these cases there is no way to know how the third-party network will handle calls from ActiveControl-enabled devices, the handling mechanism may reject them. To avoid such calls failing, leave iX disabled on all trunks to third-party networks.
- for Cisco VCS-centric deployments which connect to external networks or connect internally to older Unified CM versions. From Cisco VCS X8.1, you can turn on a zone filter to disable iX for INVITE requests sent to external networks or older Unified CM systems. (By default, the filter is off.)

13.4 Disabling UDT within SIP calls

ActiveControl uses the UDT transport protocol for certain features, for example sending roster lists to endpoints, allowing users to disconnect other participants while in a call, and inter-deployment participation lists. UDT is enabled by default. You can disable UDT for diagnostic purposes, for example if your call control does not use UDT, and you believe this is the reason the call control does not receive calls from the Meeting Server.

Using the Web Admin interface of the Meeting Server, select **Configuration>API**:

1. From the list of API objects, tap the ► after **/compatibilityProfiles**
2. Either click on the **object id** of an existing compatibility profile or create a new one
3. Set parameter **sipUDT = false**. Click **Modify**.
4. From the list of API objects, tap the ► after **/system/profiles**
5. Click the **View or edit** button
6. Click **Choose** to the right of parameter **compatibilityProfile**. Select the **object id** of the compatibilityProfile created in step 3 above
7. Click **Modify**.

13.5 Enabling iX support in Cisco Unified Communications Manager

Support for the iX protocol is disabled by default on the Cisco Unified Communications Manager for some SIP profiles. To enable iX support in Unified CM, you must first configure support in the SIP profile and then apply that SIP profile to the SIP trunk.

Configuring iX support in a SIP profile

1. Choose **Device > Device Settings > SIP Profile**. The Find and List SIP Profiles window displays.
2. Do one of the following:
 - a. To add a new SIP profile, click **Add New**.
 - b. To modify an existing SIP profile, enter the search criteria and click **Find**. Click the name of the SIP profile that you want to update.

The SIP Profile Configuration window displays.

3. Check the check box for **Allow iX Application Media**
4. Make any additional configuration changes.
5. Click **Save**

Applying the SIP profile to a SIP trunk

1. Choose **Device > Trunk**.
The Find and List Trunks window displays.
2. Do one of the following:
 - a. To add a new trunk, click **Add New**.
 - b. To modify a trunk, enter the search criteria and click **Find**. Click the name of the trunk that you want to update.

The Trunk Configuration window displays.

3. From the SIP Profile drop-down list, choose the appropriate SIP profile.
4. Click **Save**.
5. To update an existing trunk, click **Apply Config** to apply the new settings.

13.6 Filtering iX in Cisco VCS

To configure the Cisco VCS to filter out the iX application line for a neighbor zone that does not support the protocol, the zone must be configured with a custom zone profile that has the SIP UDP/iX filter mode advanced configuration option set to On.

To update advanced zone profile option settings:

1. Create a new neighbor zone or select an existing zone (**Configuration > Zones > Zones**).
2. In the Advanced parameters section, for **Zone profile**, choose *Custom* if it is not already selected. The zone profile advanced configuration options display.

3. From the **SIP UDP/iX filter mode** drop-down list, choose **On**.
4. Click **Save**.

13.7 iX troubleshooting

Table 12: Call handling summary for calls that contain an iX header

Scenario	Outcome
Unified CM 8.x or earlier	Calls fail
Unified CM 9.x earlier than 9.1(2)	Calls handled normally but no ActiveControl
Unified CM 9.1(2)	Calls handled normally plus ActiveControl
Endpoint - no support for iX and no SDP implementation	Endpoint may reboot or calls may fail

14 Scheduler - Deployment

The scheduler is deployed as a new component using the Meeting Server MMP. When the scheduler is enabled, it makes API requests to the Call Bridge over the loopback interface. It is therefore a requirement that the scheduler is deployed on a Meeting Server which is also hosting a Call Bridge. It is not possible to configure the scheduler to use a remote Call Bridge.

The list of configured Web Bridges is retrieved by the scheduler using the Call Bridge APIs. Persistent C2W connections are established to each Web Bridge similar to how the Call Bridge also establishes a C2W connection to each Web Bridge. No explicit configuration is required to enable connection between the scheduler and Call Bridge, because this happens automatically over the loopback interface. Similarly, the C2W connections are all automatic but it is necessary to [configure a trust bundle](#) between the scheduler and Web Bridges.

Note: The scheduler will need to be able to establish a C2W connection to all Web Bridges in a cluster.

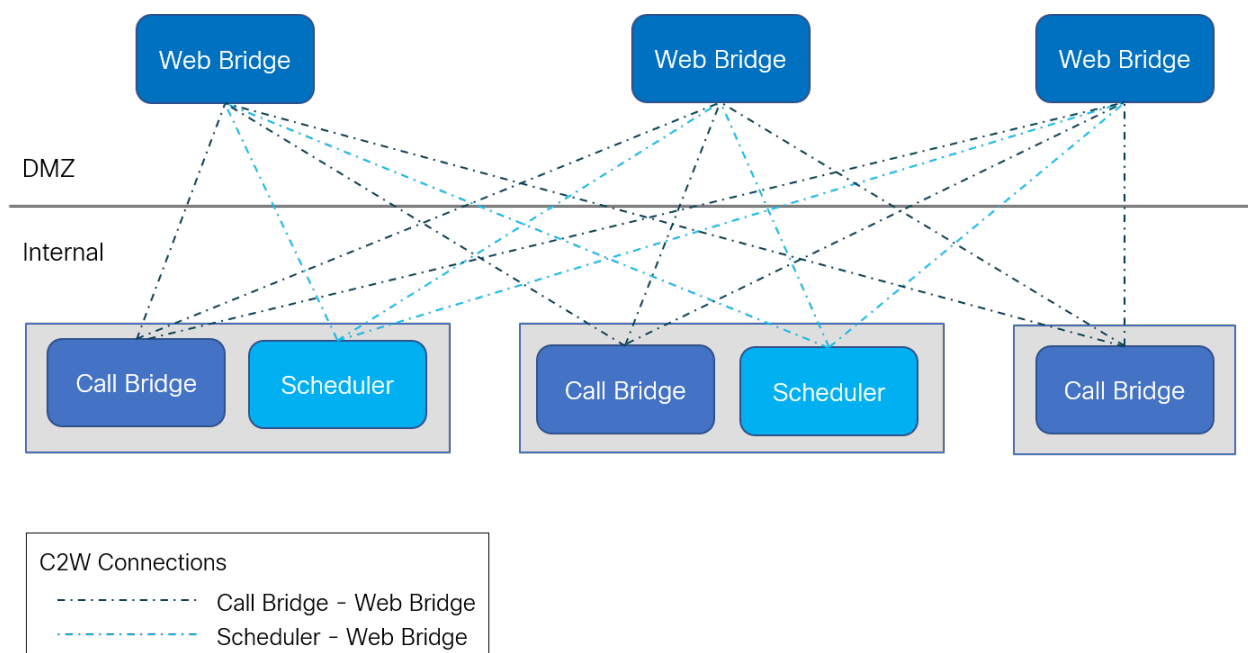

It is not necessary to deploy a scheduler alongside every Call Bridge. A scheduler on a Meeting Server 1000 and Meeting Server on VM deployments supports 150,000 meetings and a scheduler on Meeting server 2000 supports 200,000 meetings. Two or three schedulers can be added to provide resiliency. Scheduled meeting data is stored in the Meeting Server database and both clustered and single box database deployments are supported.

The Call Bridge may log API requests from the scheduler as user "scheduler". This is for logging purposes only and not a real account. There is no built-in account and the scheduler

user does not need to explicitly create an account. The scheduler uses the Call Bridge API over the loopback interface and is automatically a trusted source to issue API commands.

14.1 Deploying the Scheduler

To enable connection between the scheduler and Call Bridge, no explicit configuration is needed. This happens automatically over the loopback interface. Similarly, the C2W connections are all automatic, but it is necessary for a trust bundle to be configured between the scheduler and Web Bridges.

1. Configure C2W Trust.

C2W is a TLS-based WebSocket connection established from the scheduler to each Web Bridge. Each scheduler needs to be able to connect to each Web Bridge in a cluster. The scheduler requires configuration of a client certificate and key to be used for this connection. To do this, create a certificate and upload it to the Meeting Server via SFTP or use the `pki` MMP commands to create a certificate.

Configure the scheduler to use the certificate:

```
scheduler c2w certs <key-file> <crt-fullchain-file>
```

For example:

```
scheduler c2w certs scheduler_c2w.key scheduler.cer
```

It is necessary for the scheduler to be able to trust each Web Bridge it connects to. Upload a trust bundle which contains each Web Bridge certificate, via SFTP.

Configure the scheduler using the command:

```
scheduler c2w trust webbridge_bundle.cer
```

It is also necessary for the Web Bridge to be able to trust the scheduler. So it is important to include the scheduler certificate in the bundle configured using the command:

```
webbridge3 c2w trust <crt-bundle>
```

All the necessary certs for both schedulers and Call Bridges should be included in the `<crt-bundle>`.

2. (Optional) Configure scheduler's HTTPS interface.

The scheduler has its own HTTPS interface which if enabled, can be used to configure scheduler meetings using the scheduler APIs. The Web Bridge however, does not communicate with the scheduler using the management API. Though it is not mandatory to enable the HTTPS server, it is recommended that you do so because it provides some diagnostic and troubleshooting functionality.

Configure the HTTPS server listen interface using the command:

```
scheduler https listen <interface> <port>
```

For example:

```
scheduler https listen a 8443
```

Configure a certificate key pair for the server using the command:

```
scheduler https certs <key-file> <cert-fullchain-file>
```

For example:

```
scheduler https certs scheduler_https.key scheduler_https.cer
```

3. (Optional) Configure the email server.

For more information about configuration of the email server and types of email configuration, see [Installation Guide](#).

The configuration of the server address and port, enabling email protocol, and configuring a username for authentication are specified via the following scheduler MMP commands:

```
scheduler email server <hostname|address> <port>
scheduler email server none
scheduler email username <smtp username>
scheduler email protocol <smtp|smtps>
scheduler email auth <enable|disable>
scheduler email starttls <enable|disable>
```

Email will not be configured on a scheduler if no server address is configured on it. At least one email server must be configured for the scheduler to send email invites. Emails can be sent from any scheduler and not necessarily from the scheduler which was used to schedule the meeting. If an email server is down, then a different scheduler sends the email.

4. After configuring the email server, enable the scheduler using the command:

```
scheduler enable
```

5. Check the configuration and status of the service using the command:

```
scheduler status
```

Sample output of a successful configuration:

```
1 | cms> scheduler status
2 | Status: enabled
3 | Running
4 | Database responsive at start
5 | HTTPS configured
6 | C2W configured
7 | Email server configured
8 |
```

```
9 Scheduler application status:
10 {
11     "status": "UP",
12     "components": {
13         "c2w": {
14             "status": "UP",
15             "details": {
16                 "guid": "dc06c10f-a220-42d8-b4eb-f9be3d07faf4",
17                 "webbridges": "webbridge1.mycompany.com:4443:CONNECTED,
webbridge1.mycompany.com:8443:CONNECTED,
webbridge3.mycompany.com:8443:CONNECTED"
18             }
19         },
20         "db": {
21             "status": "UP"
22         },
23         "mail": {
24             "status": "UP",
25             "details": {
26                 "location": "smtp.mycompany.com:25"
27             }
28         },
29         "ping": {
30             "status": "UP"
31         }
32     }
33 }
```

15 Additional security considerations & QoS

This chapter discusses other security features available on the Meeting Server that are in addition to authentication provided through X.509 certificates and public keys.

Note: The commands listed in this chapter are also listed in the [MMP Command Reference](#) guide.

15.1 Common Access Card (CAC) integration

The Common Access Card ([CAC](#)) is used as an authentication token to access computer facilities. The CAC contains a private key which cannot be extracted but can be used by on-card cryptographic hardware to prove the identity of the card holder.

The Meeting Server supports administrative logins to the SSH and Web Admin Interface using CAC. Use the MMP commands in Table 13 below to configure CAC for your deployment.

Table 13: MMP commands to configure CAC logins

MMP commands	Description
<code>cac enable disable [strict]</code>	Enables/disables CAC mode with optional strict mode removing all password-based logins
<code>cac issuer <ca cert-bundle></code>	Identifies trusted certificate bundle to verify CAC certificates
<code>cac ocsp certs <keyfile> <certificatefile></code>	Identifies certificate and private key for TLS communications with OCSP server, if used
<code>cac ocsp responder <URL></code>	Identifies URL of OCSP server
<code>cac ocsp enable disable</code>	Enables/disables CAC OCSP verification

15.2 Online Certificate Status Protocol (OCSP)

OCSP is a mechanism for checking the validity and revocation status of certificates. The MMP can use OCSP to work out whether the CAC used for a login is valid and, in particular, has not been revoked.

15.3 FIPS

You can enable a FIPS 140-2 level 1 certified software cryptographic module, then cryptographic operations are carried out using this module and cryptographic operations are restricted to the FIPS approved cryptographic algorithms.

Table 14: MMP commands to configure FIPS

MMP commands	Description
<code>fips enable disable</code>	Enables/disables the FIPS-140-2 mode cryptography for all cryptographic operations for network traffic. After enabling or disabling FIPS mode, a reboot is required
<code>fips</code>	Displays whether FIPS mode is enabled
<code>fips test</code>	Runs the built-in FIPS test

15.4 TLS certificate verification

You can enable Mutual Authentication for SIP and LDAP in order to validate that the remote certificate is trusted. When enabled, the Call Bridge will always ask for the remote certificate (irrespective of which side initiated the connection) and compare the presented certificate to a trust store that has been uploaded and defined on the server.

Table 15: MMP commands to configure TLS

MMP commands	Description
<code>tls <sip ldap> trust <cert bundle></code>	Defines Certificate Authorities to be trusted
<code>tls <sip ldap> verify enable disable ocsp</code>	Enables/disables certificate verification or whether OCSP is to be used for verification
<code>tls <sip ldap></code>	displays current configuration

15.5 User controls

MMP admin users can:

- Reset another admin user's password
- Set the maximum number of characters that can be repeated in a user's password – and there are a number of other user password rule additions
- Limit MMP access by IP address
- Disable MMP accounts after configurable idle period

15.6 Firewall rules

The MMP supports the creation of simple firewall rules for both the media and admin interfaces. Note that this is not intended to be a substitute for a full standalone firewall solution and therefore is not detailed here.

Firewall rules must be specified separately for each interface. After setting up a firewall rule on an interface, remember to enable the firewall on that interface. See the [MMP Command Reference](#) for full details and examples.

CAUTION: We recommend using the serial console to configure the firewall, because using SSH means that an error in the rules would make the SSH port inaccessible. If you must use SSH then ensure that an allow `ssh rule` is created for the ADMIN interface before enabling the firewall.

15.7 DSCP

You can enable DSCP tagging for the different traffic types on the Meeting Server (see the [MMP Command Reference](#)).

1. Sign in to the MMP.
2. Use `dscp (4|6) <traffic type> (<DSCP value>|none)` to set the DSCP values as required. For example: `dscp 4 oa&m 0x22` which sets operations, administration and management for IPv4.
3. Alternatively, use the `dscp assured (true|false)` command to force the use of the assured or non-assured DSCP values for the "voice" and "multimedia" traffic types. For example: `dscp assured true`

Note: DSCP tagging is for all packets being sent from the Meeting Server only. For PC Client DSCP tagging, Group Policy must be used to define desired DSCP values because Windows controls this, and normal user accounts have no permissions to set DSCP.

15.8 Verifying SSH fingerprints

Administrators connecting to the Meeting Server for the first time via SSH or SFTP, can verify the keys prompted by the Meeting Server by retrieving the fingerprints of the keys installed on the meeting server before logging in.

Table 16: MMP command to retrieve the keys

MMP Command	Description
<code>ssh server_key list</code>	<p>The output displays a list of keys along with the size, type, and fingerprints for all existing keys in the Meeting Server host, among the following keys:</p> <ul style="list-style-type: none">• <code>ssh_host_dsa_key.pub</code>• <code>ssh_host_ecdsa_key.pub</code>• <code>ssh_host_ed25519_key.pub</code>• <code>ssh_host_key.pub</code>• <code>ssh_host_rsa_key.pub</code>

16 Diagnostic tools to help Cisco Support troubleshoot issues

In addition to using Syslog records (see [Section 3.1.4](#)) to help diagnose deployment issues, the following features are available on the Meeting Server:

- [SIP tracing](#)
- [log bundle](#)
- [generate keyframe for specific call leg](#)
- [regular reporting of registered media modules](#)

16.1 SIP Tracing

You can enable additional SIP tracing using the **Logs > Detailed tracing** page in the Web Admin Interface. These logs may be useful when investigating call setup failure issues for SIP endpoints and should be disabled at all other times. To prevent the verbose logging being enabled for longer than necessary, it automatically shuts off after a choice of 1 minute, 10 minutes, 30 minutes or 24 hours. Refer to the Meeting Server Support FAQs on the Cisco website for more troubleshooting information.

Diagnostics for failed login attempts include:

- the IP address of the far end included in event log messages relating to logins
- audit messages generated for unsuccessful logins (minus the user name) and log in session timeouts. They are also generated for successful logins.

16.2 Log bundle

Meeting Server can produce a log bundle containing the configuration and state of various components in the Meeting Server. This log bundle includes the syslog and live.json files. If you need to contact Cisco support with an issue, these files will aid them to speed up their analysis.

The Meeting Server log bundle is generated in the following ways:

- Meeting Server admin can initiate the log bundle download process by connecting the SFTP client to the MMP IP address using the MMP admin user credentials. The system generates and downloads a log bundle with file name **logbundle.tar.gz**.
- Alternatively, the admin can generate the log bundle before initiating the download process using the `generate_logbundle` command. A log bundle with file name **generatedlogbundle.tar.gz** is generated.

Command/Examples	Description/Notes
<code>generate_logbundle</code>	Generates the log bundle with the file name <code>generatedlogbundle.tar.gz</code> on the respective meeting server. Note: Each time this command is executed the latest log bundle replaces the log bundle that was generated earlier.

Download the log bundle using the steps mentioned below:

1. Connect your SFTP client to the IP address of the MMP.
2. Log in using the credentials of an MMP admin user.
3. Run one of these commands in the location where the log bundle must be downloaded:
 - a. `sftp get logbundle.tar.gz`
 - b. `sftp get generatedlogbundle.tar.gz`
4. Copy the file `logbundle.tar.gz/generatedlogbundle.tar.gz` to a local folder.
5. Rename the file, changing the logbundle part of the filename to identify which server produced the file. This is important in a multi-server deployment.
6. Send the renamed file to your Cisco Support contact for analysis.

Initial file size of the log bundle.tar.gz is 1 Kb, after transfer via SFTP the size will increase depending on the number of files and their size.

Note: In the event that you are not able to download the logbundle due to a slow network connection between a computer and the Meeting Server, you can download the log and live.json files to send to Cisco Support.

16.3 Ability to generate a keyframe for a specific call leg

A `generateKeyframe` object has been added to `/callLegs/<call leg id>`. This is a debug facility, and Cisco Support may ask you to use the feature when diagnosing an issue.

Using the Web Admin interface, select **Configuration > API**, then

1. From the list of API objects, tap the ► after `/callLegs`
2. Click on the **object id** of the call leg
3. From the list of **Related objects** at the top of the page, click `/callLegs/<call leg id>/generateKeyframe`
4. Click **Create**

This will trigger the generation of a new keyframe in the outgoing video streams for the call leg in question

16.4 Reporting registered media modules in syslog

syslog can print a message every 15 minutes to allow people to monitor whether all media modules are alive and well.

An example from a Meeting Server 2000:

```
2020-08-06T13:21:39.316Z user.info cms2kapp host:server INFO : media module
status 1111111 (1111111/1111111) 7/7 (full media capacity)
```

17 Additional licensing information

Meeting Management is mandatory with Meeting Server 3.0 or later for licensing purposes. If you are using Smart Licensing, then you must connect to the Cisco Smart Software Manager. The support for local license files (traditional licensing mode) has been deprecated and license reservation is introduced.

Note: In an environment where you cannot use Meeting Management or connect to the internet due to security reasons, contact your Cisco Account team for alternate options.

17.1 Licensing

You can find the following information in this chapter:

- How Smart licences work in Meeting Server
- Expired license feature enforcement actions
- How to retrieve licensing information (Smart licensing)
- Smart licensing registration process
- Assigning Personal Multiparty licenses to users
- How Cisco Multiparty licenses are assigned
- Determining Cisco Multiparty licensing usage
- Calculating SMP Plus license usage
- Retrieving license usage snapshots from a Meeting Server
- License reporting

17.1.1 How Smart licenses work in Meeting Server – overview

Meeting Management is mandatory for licensing to work on Meeting Server 3.0 and later. A trust and interaction between Meeting Server and Meeting Management is introduced to support the new licensing using Smart or for existing customers use of installed licensing files – it's this trusted link that enables Meeting Management to license Meeting Server.

Note: For full details on using Cisco Meeting Management to administer Smart Licensing, see the [Meeting Management Administrator Guide](#).

A high level work flow for implementing Smart Licensing is as follows:

1. Register your Meeting Management to Smart Licensing Virtual Account.
2. When a Meeting Server first starts up it will have no license status values defined.

Note: You can use Trial Mode for a 90 day full featured period without licenses.

3. When Meeting Server first connects to a Meeting Management instance set up to administer Smart Licensing, it checks to see if the Meeting Server has previously had a license applied. If not, it will set the license expiry date to 90 days in the future.

The expiry date for a license is shown in Meeting Management and also returned in the clusterLicensing API, as shown in Appendix B.5.

Note: The expiry date for any feature license will only ever be up to a maximum of 90 days in the future.

4. Meeting Management collates Meeting Server licensing usage for the cluster and reports to your Smart Account on a daily basis to check that it has the licenses required to ensure the Meeting Server is in compliance. The Smart Account responds to Meeting Management to indicate if the Meeting Server is compliant or not. Meeting Management then sets the expiry dates as appropriate as follows:

- a. If the Meeting Management identifies that a license exists and is below entitlement for a particular feature, the expiry date will be extended to 90 days in the future.

Note: If Meeting Server doesn't connect to Meeting Management and send usage data for a period of 90 days then the Meeting Server's license won't get refreshed and will therefore expire. For information on the enforcement actions when a license expires, see [Section 17.1.2](#).

If a license usage is higher than the entitlement, or a license is not found, then enforcement occurs as follows.

- b. If Meeting Management identifies that less than 15 out of the last 90 days are non-compliant, it will allow this and reset the Meeting Server expiry date to 90 days in the future from that point. The admin will get a visual warning to notify "Insufficient licenses".
- c. If Meeting Management identifies that more than 15 of the last 90 days are non-compliant, the first level of enforcement (Alarm 1) will occur, i.e. out of compliance notifications on the Meeting Management interface.
- d. If overage continues, Meeting Management does not reset the 90 day clock, it gives you a countdown in xx days in which to add new licenses otherwise Alarm levels 2 and 3 will be enabled for all participants joining a meeting as shown in Figure 20.

Figure 20 shows the enforcement flow from initial start up in trial mode on the left-hand side through to overage enforcement as shown on the right-hand side.

Figure 20: Cisco Meeting Server and Cisco Meeting Management Smart Licensing enforcement flow

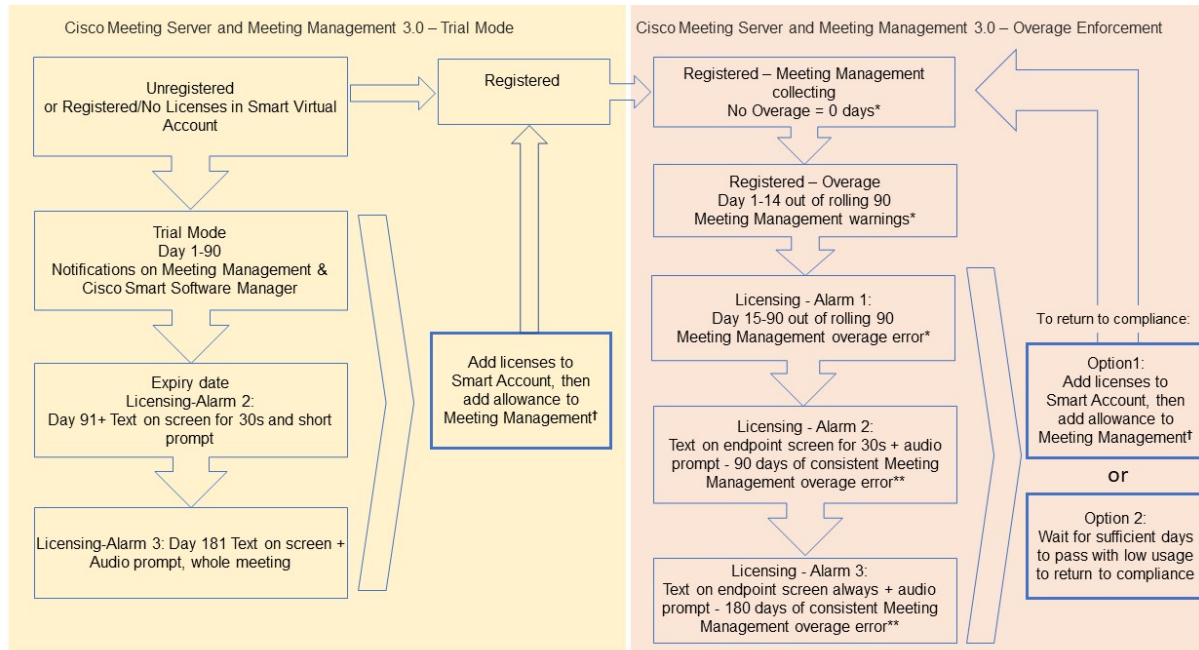

* Counting days of overage (i.e. where usage is higher than the entitlement)

** Counting days where Meeting Management is in an error state (i.e. the state where there are 15 continuous days overage out of the last 90 days)

† To ensure accurate reporting, the administrator needs to specify within Meeting Management the number of licenses that are held in the Smart Account

17.1.2 Expired license feature enforcement actions

Previously, Meeting Server would evaluate its license file on restart only. From 3.0 the current status of whether a feature is licensed or not can change dynamically, for example, because a feature license expires (previously this would not have been evident until a restart), or there has been an API change. Meeting Management will calculate enforcement actions with Smart Licensing.

Note: You can use the Smart Licensing portal to enable email notifications for "insufficient licenses".

When a license feature has expired the actions described in Table 17 will occur.

Table 17: Expired license enforcement actions

Feature	Action
callBridge	When expired: a visual text message displays on screen lasting 30 seconds and an audio prompt plays on joining a meeting for all participants/all meetings. (Alarm level 2)
callBridgeNoEncryption	When expired more than 90 days ago or no license present: the same as before but the visual message is permanent. The audio prompt plays " Your deployment is out of licensing compliance, please contact your administrator" . (Alarm level 3) . However, encrypted calls are not processed in the unlicensed state.
PMP/SMP	Note: you only need callBridge or callBridgeNoEncryption to prevent the above action.
customizations	When expired or not present, customization features will not be active during a meeting.
recording	When expired or not present you will not be able to start a new recording (regardless of whether it is a 3rd party recorder or not). This license represents recording and streaming so the same restrictions also apply to streaming.

To turn off Alarms 2 and 3, simply add more licenses to your Smart Account.

17.1.3 How to retrieve licensing information (Smart Licensing)

To retrieve licensing information for a cluster using the Meeting Server Web Admin interface:

1. Log in to the Meeting Server Web Admin interface and select **Configuration > API**:
2. From the list of API objects, tap the ► after **/api/v1/clusterLicensing**
3. The current license status for the cluster is displayed as shown in this example:

Figure 21: clusterLicensing API – license status

Object configuration		
features	callBridge	status activated expiry 2020-09-16
	callBridgeNoEncryption	status noLicense
	customizations	status activated expiry 2020-09-16
	recording	status activated expiry 2020-09-16

17.1.4 Smart Licensing registration process

To enable Smart Licensing:

1. Sign in to Cisco Smart Software Manager (CSSM) portal and choose Virtual Account with Meeting Server Licenses.
2. Generate a registration token.
3. Copy the token to your clipboard.
4. Open the instance of Meeting Management that you want to use for license reporting.
5. Go to the **Settings** page, **Licensing** tab.
6. Click **Change**.
7. Choose **Smart Licensing** and **Save**.
8. Click **Register**.
9. Paste the registration token (this allows Meeting Management to connect to the Smart Licensing portal).
10. Click **Register**.
11. When you have registered, check how many licenses you have in your Virtual Account.
12. In Meeting Management, go to the **Licenses** page.
13. Enter the license information for the licenses you have in your Virtual Account.

If any licenses are not shown in your Virtual Account, use the **Convert Licenses** tab, search by PAK to find them, then choose **Convert Licenses** as shown in Figure 22. (If you can't find a license(s), open a case by sending an email to licensing@cisco.com.)

Figure 22: License conversion for Smart Licensing

Cisco Software Central > Smart Software Licensing BU Production Test 1

Smart Software Licensing Feedback Support Help

Alerts | Inventory | **Convert to Smart Licensing** | Reports | Preferences | On-Prem Accounts | Activity

License Conversion

Convert PAKs | Convert Licenses | Conversion History | Event Log

The Product Activation Keys (PAKs) below contain licenses that can be used for traditional licensing or Smart Software Licensing. To add some or all of them to a Virtual Account as Smart Software Licenses, use the "Convert to Smart Licenses" action in the table below.

If you do not see a PAK you expect to see in the table, ensure that it has been assigned to your Smart Account in the [Product License Registration Portal](#).

i The Smart Account administrator may be able to more easily convert the licenses based on the automatic conversion settings.

Last Updated : 2020-Jul-20 16:30:09 **i**

PAK	SKUs	Order Number	Order Date	Virtual Account	Status	Actions
-----	------	--------------	------------	-----------------	--------	---------

17.1.5 Multiparty licensing

17.1.5.1 Personal Multiparty plus licensing

Personal Multiparty Plus (PMP Plus) provides a named host license assigned to each specific user who frequently hosts video meetings. This can be purchased through Cisco UWL Meeting

or Flex Meetings (which includes PMP Plus). Personal Multiparty Plus is an all-in-one licensing offer for video conferencing. It allows users to host conferences of any size (within the limits of the Cisco Meeting Server hardware deployed). Anyone can join a meeting from any endpoint, and the license supports up to full HD 1080p60 quality video, audio, and content sharing.

Note: Using Unified Communications Manager, the initiator of an Ad Hoc conference can be identified and if they have been assigned a PMP Plus license then that is used for the conference.

Note: To determine the number of active calls using the PMP Plus licence of an individual, use the parameter `callsActive` on API object `/system/multipartyLicensing/activePersonalLicenses`. We generally allow 2 calls to be active allowing for one starting and other finishing. If the call is on a cluster of Call Bridges then use the parameter `weightedCallsActive` on API object `/system/multipartyLicensing/activePersonalLicenses` for each Call Bridge in the cluster. The sum of `weightedCallsActive` across the cluster matches the number of distinct calls on the cluster using the individual's PMP Plus license. If a PMP Plus licence is exceeded, then SMP Plus licences are assigned, see [Section 17.1.1](#).

17.1.5.2 Shared Multiparty plus licensing

Shared Multiparty Plus (SMP Plus) provides a concurrent license that is shared by multiple users who host video meetings infrequently. Shared Multiparty Plus enables all employees who do not have PMP Plus host license to access video conferencing. It is ideal for customers that have room systems deployed that are shared among many employees. All users with PMP Plus or using SMP Plus licenses have the same great experience, they can host a meeting with their space, initiate an ad-hoc meeting or schedule a future one. Each shared host license supports one concurrent video meeting of any size (within the limits of the hardware deployed).

Note: To determine the number of SMP Plus licences required, use the parameter `callsWithoutPersonalLicense` on API object `/system/multipartyLicensing`. If the calls are on a cluster of Call Bridges then use the parameter `weightedCallsWithoutPersonalLicense` on API object `/system/multipartyLicensing` for each Call Bridge in the cluster. The sum of `weightedCallsWithoutPersonalLicense` across the cluster matches the number of distinct calls on the cluster which require an SMP Plus license.

17.1.6 Assigning Personal Multiparty licenses to users

This process requires that users are imported from a single LDAP source. See the "Provisioning – Import users" chapter in the [Meeting Management 3.0 Administrator Guide](#) for full details.

17.1.6.1 To determine whether a specific user has a license:

1. From the list of API objects, tap the ► after `/users`
 - a. Select the **object id** of the specific user
 - b. Identify the **object id** of the **userProfile** associated with this user
2. From the list of API objects, tap the ► `/userProfiles`
 - a. Select the **object id** of the specific userProfile
 - b. Find the setting for parameter **hasLicence**. If set to **true** then the user identified in step 1 is associated with a Cisco Multiparty user license. If set to **false** the user is NOT associated with a Cisco Multiparty user license.

Note: If the userProfile is deleted, then the userProfile is unset for the ldapSource and the imported users.

17.1.7 How Cisco Multiparty licenses are assigned

When a meeting starts in a space, a Cisco license is assigned to the space. Which license is assigned by the Cisco Meeting Server is determined by the following rules:

- if the space owner is defined and corresponds to a Meeting Server imported LDAP user with an assigned Cisco PMP Plus license, the license of that owner is assigned irrespective of whether the person is active in the conference, if not, then
- if the meeting was created via ad hoc escalation from Cisco Unified Communications Manager, then Cisco Unified Communications Manager provides the GUID of the user escalating the meeting. If that GUID corresponds to a Meeting Server imported LDAP user with an assigned Cisco PMP Plus license, the license of that user is assigned, if not, then
- if the meeting was scheduled via Cisco TMS version 15.6 or newer, then TMS will provide the owner of the meeting. If that user corresponds to a Meeting Server imported LDAP user by user ID/email address with an assigned Cisco PMP Plus license, the license of that user is assigned to the meeting, if not then,
- a Cisco SMP Plus license is assigned.

17.1.8 Determining Cisco Multiparty licensing usage

We recommend you use Meeting Management to view your Multiparty licensing usage. However, the API can be used.

Table 18 below lists the API objects and parameters that can be used to determine the consumption of Multiparty licenses.

Table 18: Objects and parameters related to Multiparty license usage

API object	Parameter (s)	Use to
/system/licensing	personal, shared	determine whether components of the Cisco Meeting Server have a Multiparty license and are activated. Values are: noLicense, activated, grace, expired. Also provides date of expiry and number limit.
/system/multipartyLicensing	personalLicenseLimit, sharedLicenseLimit, personalLicenses, callsWithoutPersonalLicense, weightedCallsWithoutPersonalLicense	indicates the number of licenses available and in use
/system/multipartyLicensing/ activePersonalLicenses	callsActive, weightedCallsActive	indicates the number of active calls that are using a Personal Multiparty Plus user license,
/userProfiles	hasLicense	indicates whether or not a user is associated with a Cisco Multiparty user license

For more information on these additional object and fields to support Cisco Multiparty licensing, refer to the [Cisco Meeting Server API Reference Guide](#).

17.1.9 Calculating SMP Plus license usage

For the following specific scenarios, the SMP Plus license consumed for a meeting is reduced to 1/6th of a full SMP Plus license:

- an audio-only conference where no attendees are using video,
- a Lync gateway call unless the Meeting Server is recording or streaming, at which point it is considered a full conference and a full SMP Plus license is consumed,
- a point to point call involving a web app and a SIP endpoint, or two web apps, unless the Meeting Server is recording or streaming, at which point it is considered a full conference and a full SMP Plus license is consumed.

A full SMP Plus license is consumed for any audio-video conference instantiated from a space with the owner property undefined, owned by an imported LDAP user without a PMP Plus license, or owned by an imported LDAP user whose PMP Plus license has already been consumed, this is irrespective of the number of participants.

Note: A point to point call is defined as:

- having no permanent space on the Meeting Server,
- two or less participants, including the recorder or streamer
- no participants hosted on the Lync AVMCU,

This includes Lync Gateway calls as well as other types of calls: point-to-point web app to web app, web app to SIP and SIP to SIP.

17.1.10 Retrieving license usage snapshots from a Meeting Server

An administrator can retrieve license usage from the Meeting Server. These cannot be accessed through the Web Admin Interface, instead use an API tool such as POSTMAN:

Use GET on `/system/MPLicenseUsage/knownHosts` to retrieve host ids of the Meeting Servers in the deployment. Supply an offset and limit if required to retrieve host ids other than those on the first page of the list.

Use GET on `/system/MPLicenseUsage` to retrieve license usage from the Call Bridge of the Meeting Server with the specified host id. Supply a start and end time for the snapshot. Provides information on number of personal licenses in use, number of shared licenses in use which are audio only, point to point, or neither audio or point to point, number of calls being recorded and number of streamed calls.

Note: Note: personal and shared licenses are normalized over the number of Call Bridges that the call spans.

17.1.11 License reporting

Meeting Management has license reporting/usage information for the last 90 days, and Cisco Smart Software Manager also contains license reporting information. The usage of recording licenses indicates the number of conferences recording concurrently, similarly the streaming license usage indicates the number of conferences streaming concurrently.

17.1.12 Legacy licensing file method

This section only applies if you are using the traditional licensing method. From version 3.4, the support for traditional licensing has been deprecated. The existing local licenses will still be supported until the license expires.

17.1.12.1 Obtaining Cisco user licenses using the traditional licensing method

This section assumes that you have already purchased the licenses that will be required for your Meeting Server from your Cisco Partner and you have received your PAK code(s).

Follow these steps to register the PAK code with the MAC address of your Meeting Server using the [Cisco License Registration Portal](#).

1. Obtain the MAC address of your Meeting Server by logging in to the MMP of your server, and enter the MMP command: **iface a**

Note: This is the MAC address of your VM, not the MAC address of the server platform that the VM is installed on.

2. Open the [Cisco License Registration Portal](#) and register the PAK code(s) and the MAC address of your Meeting Server.
3. If your PAK does not have an R-CMS-K9 activation license, you will need this PAK in addition to your feature licenses.
4. The license portal will email a zipped copy of the license file. Extract the zip file and rename the resulting xxxxx.lic file to **cms.lic**.
5. Using your SFTP client, log into Meeting Server and copy the **cms.lic** file to the Meeting Server file system.
6. Restart the Call Bridge using the MMP command **callbridge restart**
7. After restarting the Call Bridge, check the license status by entering the MMP command **license**
The activated features and expirations will be displayed.

18 Obtaining information on hosted conferences

There are two mechanisms for obtaining information on conferences hosted on the Meeting Server which remove the need to constantly poll the API: Call Detail Records and Events.

Note: You can configure Cisco Meeting Management as a CDR (Call Detail Record) receiver and events client on each Call Bridge to get information about active meetings via API requests, CDRs, and Meeting Server events. For more information, see the [Meeting Management User Guide for Administrators](#).

18.1 Call Detail Records (CDRs)

The Meeting Server generates Call Detail Records (CDRs) internally for key call-related events, such as a new SIP connection arriving at the server, or a call being activated or deactivated.

The server can be configured to send these records to a remote system to be collected and analyzed. There is no provision for records to be stored on a long-term basis on the Meeting Server, nor any way to browse CDRs on the Meeting Server itself.

The CDR system can be used in conjunction with the Meeting Server API, with the call ID and call leg IDs values being consistent between the two systems to allow cross referencing of events and diagnostics.

The Meeting Server supports up to four CDR receivers, enabling you to deploy different management tools or multiple instances of the same management tool, such as Cisco Meeting Management. For more information, see the [Cisco Meeting Server Call Detail Records Guide](#).

18.2 Events

Meeting Server can notify an "events client" in real-time of changes that are occurring on the Meeting Server. The Meeting Server acts as a server for the events, and the events client could be for example, a web-based management application. Cisco Meeting Management acts as an events client.

Note: You can construct your own events client, which is similar to constructing an API client. The events client needs to support HTTP and WebSocket libraries, both are available in common scripting languages like Python. The events port on the Meeting Server is the same port as you configured for the Web Admin, typically TCP port 443 on interface A.

Rather than continually poll an API resource on the Meeting Server, an events client can subscribe to an event resource to receive updates. For example, after establishing a WebSocket connection between the events client and the Meeting Server, the events client can subscribe to the event resource `callRoster` and receive updates on the participant list of

an active conference to find out when a new participant joins, or an existing participant changes layout etc.

For more information, see the [Cisco Meeting Server Events Guide](#).

Appendix A DNS records needed for the deployment

Note: You can configure the DNS resolver(s) to return values which are not configured in external DNS servers or which need to be overridden; custom Resource Records (RRs) can be configured which will be returned instead of querying external DNS servers. (The RR is not available to clients.) See the [MMP Command Reference](#) for details.

Note: Verify that no A or SRV records already exist for any Meeting Servers before defining the records below.

Table 19: DNS records required for deployment

Type	Example and Description
A / AAAA	<p>join.example.com</p> <p>Resolves to: IP address of Web Bridge.</p> <p>Description: This record is not used by the Meeting Server directly; however, it is common practice to provide an end user with an FQDN to type into the browser which resolves to the Web Bridge. There is no restriction or requirement on the format of this record.</p>
A / AAAA	<p>uk.example.com</p> <p>Resolves to: IP address of the Call Bridge.</p> <p>Description: Used by the Lync FE server to contact the Call Bridge.</p>
A / AAAA	<p>ukadmin.example.com</p> <p>Resolves to: IP address of the MMP Interface IP address of the Web Admin Interface.</p> <p>Description: This record is used purely for admin purposes; when system administrators prefer a FQDN to remember for each MMP interface.</p>

Type	Example and Description
SRV(*)	<p><code>_sipinternaltls._tcp.<yourLyncdomain></code></p> <p>Resolves to: The A record of the Lync FE server or FE Pool.</p> <p>Description: If you have an FE pool, you can have multiple FE records pointing to individual FE servers within the pool. You also need this record if you want Meeting Server to resolve Lync meetings by Lync meeting IDs.</p>
A / AAAA	<p><code>fe.<yourLyncdomain></code></p> <p>Resolves to: IP address of the Lync FE server.</p> <p>Description: You will need one record for each individual FE server.</p>
SRV(*)	<p><code>_sipfederationtls._tcp.<yourSIPdomain></code></p> <p>Resolves to: The FQDN of the Call Bridge.</p> <p>Description: This record is required for Lync federation.</p>
A	<p><code>callbridge.example.com</code></p> <p>Resolves to: IP address of the Call Bridge.</p> <p>Description: Required for Lync federation as the Call Bridge will need to have a public IP address, and NAT is not supported in this scenario.</p>

(*) SRV records do not resolve directly to IP addresses. You need to create associated A or AAAA name records in order to satisfy the SRV requirements.

Appendix B Ports required for the deployment

The following diagram shows the connections to the Meeting Server and location of the firewall in a combined server deployment. Use the tables below the diagram to identify which ports to open.

Figure 23: Ports that must be open in a combined server deployment with Expressway in the DMZ

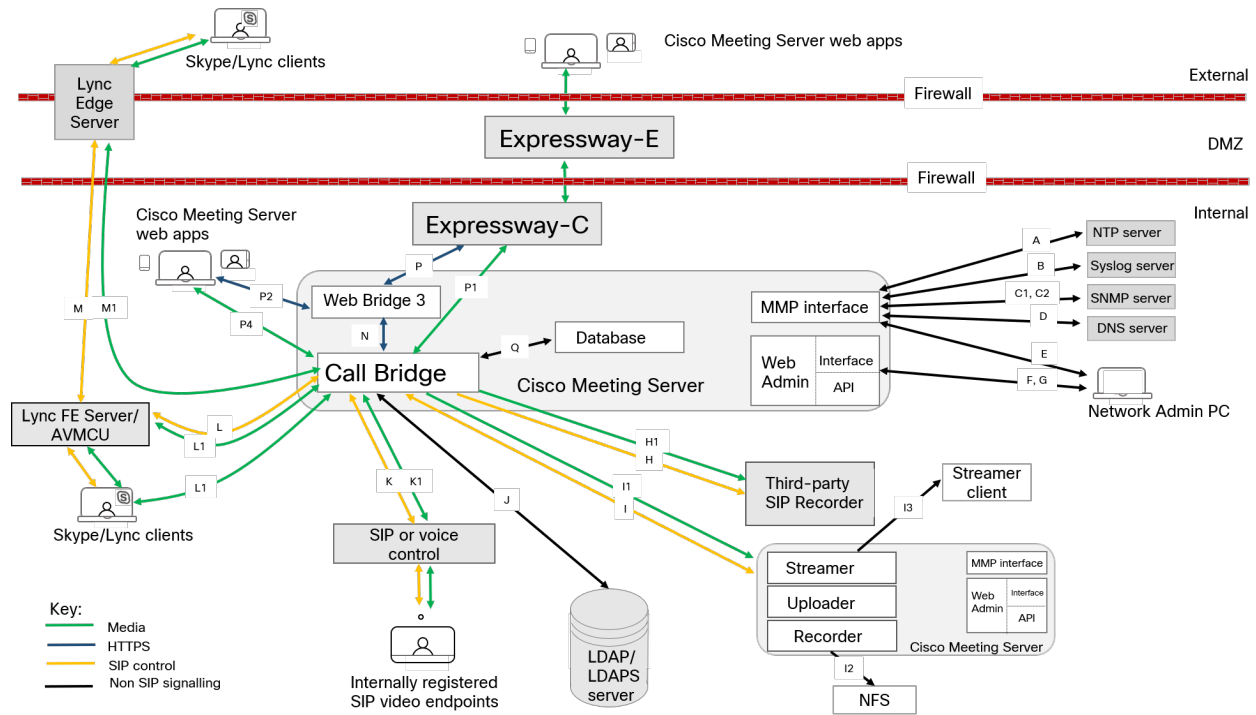

B.1 Configuring the Meeting Server

Table 20 lists the ports to use to configure the Meeting Server.

Table 20: Ports for administration of the Meeting Server

Code	Connect to	Destination port to open	Method	Traffic type	Traffic direction with respect to Meeting Server	Additional information
E	MMP	22	SSH	TCP	Incoming	Secure login to MMP
F	API or Web Admin	80	HTTP	TCP	Incoming	Port enabled/disabled through MMP
G	API or Web Admin	443	HTTPS	TCP	Incoming	Port configurable through MMP

B.2 Connecting services

Use Table 21 to identify which ports are used to connect different services to the web app.

Table 21: Ports to open to connect services

Code	Component	Connecting to	Destination port to open	Traffic type	Traffic direction with respect to component	Additional information
A	MMP	NTP server	123	TCP or UDP	Outgoing	
B	MMP	Syslog server	514	TCP	Outgoing	Default port, different port configurable through MMP
C1	MMP	SNMP server	161	UDP	Incoming	
C2	MMP	SNMP TRAP	162	TCP or UDP	Outgoing	
D	MMP/Call Bridge/Web Bridge	DNS server	53	TCP or UDP	Outgoing	
	Call Bridge	CDR recipient device		TCP	Outgoing	set URI of CDR recipient in Web Admin interface, or API using API object /system/cdrReceivers/

B.3 Using Meeting Server components

Use Table 22 to identify which ports are used to connect to the components in the Meeting Server and the ports that need to be open through the firewall.

Table 22: Ports to open to use Meeting Server components

Code	Component	Connecting to	Destination port to open	Traffic type	Traffic direction with respect to component	Additional information
H	Call Bridge	3rd party SIP recorder	5060	TCP (SIP)	Outgoing	
			5060	UDP (SIP)		
			5061	TLS (SIP)		

Code	Component	Connecting to	Destination port to open	Traffic type	Traffic direction with respect to component	Additional information
H1	Call Bridge	3rd party SIP recorder		Media	Outgoing	ports determined by 3rd party SIP recorder
			32768-65535	UDP (STUN, RTP, BFCP)	Incoming	
I	Call Bridge	Recorder/Streamer	5060	TCP (SIP)	Outgoing	Ports configurable through MMP. For a local recorder use the loop-back interface, e.g. lo:8443
			5061	TLS (SIP)		
			5060	TCP (SIP)	Incoming	
			5061	TLS (SIP)		
I1	Call Bridge	Recorder/Streamer	32768-65535	Media	Outgoing	
			32768-65535	UDP (STUN, RTP, BFCP)	Incoming	
I2	Recorder	Network File Server (NFS)				Use the MMP command recorder nfs <host-name/IP<directory> to specify where to store the recordings on the NFS
I3	Streamer	Streamer client	1935	RTMP	Outgoing	
J	Call Bridge	LDAP/LDAPS (Active Directory)	389/636 (Note 1)	TCP/TCP (SIP TLS)	Outgoing	Port configurable through Web Admin interface
K	Call Bridge	Internal registered SIP endpoint or voice call control	5060	UDP (SIP), TCP (SIP)	Incoming and outgoing	
			5061	TCP (SIP TLS)		

Code	Component	Connecting to	Destination port to open	Traffic type	Traffic direction with respect to component	Additional information
K1	Call Bridge	Internal registered SIP endpoint or voice call control	32768-65535	UDP (STUN, RTP, BFCP)	Incoming	
L	Call Bridge	Lync FE server/AVMCU	5061	TCP (SIP TLS)	Incoming and outgoing	
L1	Call Bridge	Lync client, Lync FE server / AVMCU	1024-65535 (Note 2)	UDP (STUN, RTP)	Outgoing	
			32768-65535	UDP (STUN, RTP)	Incoming	
			1024-65535 (Note 2)	TCP (RDP)	Outgoing	
			32768-65535	TCP (RDP)	Incoming	
M	Call Bridge	Lync Edge server	3478	UDP	Outgoing	
			443	TCP	Outgoing	
M1	Call Bridge	Lync Edge server	32768-65535	UDP (STUN, RTP)	Incoming	
N	Call Bridge	Web Bridge 3		TCP (C2W)	bidirectional data flow	
P	Web Bridge 3	Expressway	443	TCP (HTTPS)	Incoming and outgoing	
			80	TCP (HTTP)	Incoming	Port 80 optional for HTTP > HTTPS redirect
P1	Call Bridge	Expressway	1024-65535	UDP (STUN, RTP)	Incoming and outgoing	Port 3478 always in use, ephemeral ports will be allocated within the range as needed per call
P2	Web Bridge 3	Cisco Meeting Server web app	443	TCP (HTTPS)	Incoming and outgoing	Port 80 optional for HTTP > HTTPS redirect

Code	Component	Connecting to	Destination port to open	Traffic type	Traffic direction with respect to component	Additional information
P4	Call Bridge	Cisco Meeting Server web app	1024-65535	Media TCP/UDP (STUN RTP)	Incoming and outgoing	
Q	Call Bridge	Database				Internal to Meeting Server, does not require open ports on the firewall

Note:

Note 1: Port 636 (secure) and 389 (non-secure) are commonly used for this function but the port is configurable through the Web Admin interface. The same applies to 3268 and 3269 (non-secure and secure) global catalog LDAP requests.

Note 2: Exact range depends on configuration of Lync server.

Note 3: Admin may optionally enable 3478 TCP or another customer TCP port for TURN.

Note 4: TURN and Media ranges assume web app allocates TURN relay and Call Bridge does not create TURN relays as documented in this guide.

B.4 Ports open on loopback

The ports listed in Table 23 are open on the loopback interface.

Table 23: Ports on loopback

Port	Usage	Notes
53	DNS	
123	NTP	
1234	HTTP	Not applicable to Cisco Meeting Server 2000
2829, 2830	Server to media internal connection	
3521	configd	
5432	postgres	
5060	SIP	always open
5061	encrypted SIP	only if certificates applied to Call Bridge
5070	BFCP	only on IPv6
8080	HTTP	always open
8081	HTTP	if webadmin enabled
3478	STUN	

Appendix C Call capacities by Cisco Meeting Server platform

Table 24 below details maximum call capacities on Meeting Servers by upgrading to later software versions. Note that there are different capacities for a single or cluster of Meeting Servers compared to load balancing calls within a Call Bridge Group.

Table 24: Meeting Server call capacity for clusters and Call Bridge groups

Cisco Meeting Server platform		Cisco Meeting Server 1000 M5v2	Cisco Meeting Server 1000 M6	Cisco Meeting Server 2000 M5v2	Cisco Meeting Server 2000 M6
Individual Meeting Servers or Meeting Servers in a cluster (notes 1, 2, 3, and 4)	1080p30	60	80	437	648
	720p30	120	160	875	1296
	SD	240	320	1250	1875
	Audio calls	2200	3000	3000	3200
and Meeting Servers in a Call Bridge Group	HD participants per conference per server	120		450	
	web app call capacities (internal calling & external calling on CMS web edge):				
	Full HD	60	80	437	648
	HD	120	160	875	1296
	SD	240	320	1250	1875
	Audio calls	500	500	1250	1875
Meeting Servers in a Call Bridge Group	Call type supported				
	Load limit	120,000		875,000	

Note 1: Maximum of 24 Call Bridge nodes per cluster; cluster designs of 8 or more nodes need to be approved by Cisco, contact Cisco Support for more information.

Note 2: Clustered Cisco Meeting Server 2000's without Call Bridge Groups configured, support integer multiples of maximum calls, for example integer multiples of 700 HD calls.

Note 3: Up to 21,000 HD concurrent calls per cluster (24 nodes x 875 HD calls) applies to SIP or web app calls.

Note 4: A maximum of 2600 participants per conference per cluster depending on the Meeting Servers platforms within the cluster.

Note 5: Table 24 assumes call rates up to 2.5 Mbps-720p5 content for video calls and G.711 for audio calls. Other codecs and higher content resolution/framerate will reduce capacity. When meetings span multiple call bridges, distribution links are automatically created and also count against a server's call count and capacity. Load limit numbers are for H.264 only.

Note 6: The call setup rate supported for the cluster is up to 40 calls per second for SIP calls and 20 calls per second for Cisco Meeting Server web app calls.

Note 7: Up to 16,800 HD concurrent calls per cluster (24 nodes x 700 HD calls) applies to SIP or web app calls.

Note 8: From version 3.2, Meeting Server supports increased call capacities on Meeting Server 1000 M5v2 and Meeting Server 2000 M5v2 hardware variants.

- The load limit for Meeting Server 1000 M5v2 has increased from 96,000 to 120,000. The Meeting Server 1000 call capacity for 720p video calls has increased from a maximum of 96 to 120 on the new platform.
- The load limit for Meeting Server 2000 M5v2 has increased from 700,000 to 875,000. The Meeting Server 2000 call capacity for 720p video calls has increased from 700 to 875 on the new platform.

Note 9: Table 24 assumes call rates up to 2.5 Mbps-720p5 content for video calls and G.711 for audio calls. Other codecs and higher content resolution/framerate will reduce capacity. When meetings span multiple call bridges, distribution links are automatically created and also count against a server's call count and capacity. Load limit numbers are for H.264 only.

Note 10: The call setup rate supported for the cluster is up to 40 calls per second for SIP calls and 20 calls per second for Cisco Meeting Server web app calls.

C.1 Cisco Meeting Server web app call capacities

This section details call capacities for deployments using Web Bridge 3 and web app for external and mixed calling. (For internal calling capacities, see Table 24.)

C.1.1 Cisco Meeting Server web app call capacities – external calling

Expressway (Large OVA or CE1200) is the recommended solution for deployments with medium web app scale requirements (i.e. 800 calls or less). Expressway (Medium OVA) is the recommended solution for deployments with small web app scale requirements (i.e. 200 calls or less). However, for deployments that need larger web app scale, from version 3.1 we recommend Cisco Meeting Server web edge as the required solution which will scale up to SIP capacity (see Table 24).

External calling is when clients use Cisco Expressway as a reverse proxy and TURN server to reach the Web Bridge and Call Bridge.

When using Expressway to proxy web app calls, the Expressway will impose maximum calls restrictions to your calls as shown in Table 25.

Note: If you are deploying Web Bridge 3 and web app you must use Expressway version X14.3 or later, earlier Expressway versions are not supported by Web Bridge 3.

Table 25: Cisco Meeting Server web app call capacities – external calling

Setup	Call Type	CE1200 Platform	Large OVA Expressway	Medium OVA Expressway
Per Cisco Expressway (X14.3 or later)	Full HD	150	150	50
	Other	200	200	50

The Expressway capacity can be increased by clustering the Expressway pairs. Expressway pairs clustering is possible up to 6 nodes (where 4 are used for scaling and 2 for redundancy), resulting in a total call capacity of four times the single pair capacity.

Note: The call setup rate for the Expressway cluster should not exceed 6 calls per second for Cisco Meeting Server web app calls.

C.1.2 Cisco Meeting Server web app capacities – mixed (internal + external) calling

Both standalone and clustered deployments can support combined internal and external call usage. When supporting a mix of internal and external participants the total web app capacity will follow Appendix C for Internal Calls, but the number of participants within the total that can connect from external is still bound by the limits in Table 25.

For example, a single standalone Meeting Server 2000 with a single Large OVA Expressway pair supports a mix of 1000 audio-only web app calls but the number of participants that are external is limited to a maximum of 200 of the 1000 total.

C.2 Number of users supported on Cisco Meeting Server

From version 3.3, a Cisco Meeting Server cluster can support up to 300,000 users depending on the servers where the databases are located. All databases in the cluster must be on the same specification server.

Table 26: Number of users supported on Cisco Meeting Server

Cisco Meeting Server	Maximum number of users
Meeting Server 2000 M5v2	300,000
Meeting Server 2000 M5v1	200,000

Cisco Meeting Server	Maximum number of users
Meeting Server 2000 M4, Meeting Server 1000 M4, M5v1, M5v2, and Specification based servers	75,000

Note: LDAP sync for a large number of users can cause an increase in call join times. We advise adding new users/coSpaces onto the Meeting Server during a maintenance window or during off peak hours.

Appendix D Activation key for unencrypted SIP media

You have the choice of purchasing an activation key with SIP media encryption enabled or SIP media encryption disabled (unencrypted SIP media) for the Cisco Meeting Server 1000, Cisco Meeting Server 2000 and the VM software image. Choose either encrypted or unencrypted options under the software pids R-CMS-K9 and R-CMS-2K-K9. Media includes audio, video, content video and ActiveControl data.

Note: Current Call Bridge activations are unaffected, unless an activation key is uploaded with SIP media encryption disabled.

D.1 Unencrypted SIP media mode

If the activation key for "SIP media encryption disabled" is uploaded to the Meeting Server, then the following occurs:

- media sent between the Meeting Server and SIP devices is unencrypted,
- media sent over distribution links between clustered Call Bridges is unencrypted,
- call signalling remains encrypted,
- media in calls between the Meeting Server and web app, on any platform, remains encrypted,
- an error message is returned if the **sipMediaEncryption** parameter is set to anything other than **prohibited** on the following API objects:
 - `/calls/<call id>/participants`
 - `/calls/<call id>/callLegs`
 - `/callLegs/<call leg id>`
 - `/callLegProfiles` and `/callLegProfiles/<call leg profile id>`
 - `/callLegs/<call leg id>/callLegProfileTrace`
- an error message is displayed if the **SIP media encryption** field on the **Configuration>Call settings** web page of the Web Admin interface is set to anything other than **disabled**.

Note: If SIP media encryption is disabled, call signaling can still be encrypted on outbound calls, if required, by setting the **sipControlEncryption** parameter on `/outboundDialPlanRules`.

D.2 Determining the Call Bridge media mode

To determine whether the Call Bridge uses encrypted or unencrypted SIP media use the Web Admin interface, select **Configuration > API**, then:

1. From the list of API objects, tap the ► after **/api/v1/system/licensing**

If the **features** object **callBridgeNoEncryption** has the **status** set to **activated** then an activation key for unencrypted media is loaded on the Call Bridge. Other valid settings for the status of **callBridgeNoEncryption** are **noLicense grace** or **expired**.

callBridgeNoEncryption also has an **expiry** field in the form of a string.

Appendix E Dual Homed Conferencing

E.1 Overview

Dual homed conferencing also improves the user experience for both Lync client users and web app users in Lync scheduled meetings and in Lync drag and drop style meetings (also known as ad hoc calls). Lync participants can use drag and drop to add web app users to a Lync meeting, and can use conference controls to mute web app users or disconnect them. For web app users joining a Lync scheduled conference, they will see the video from up to five Lync participants, as well as video from the web app users. Lync users see video in a gallery format from all of the web app users, as well as the Lync users in the meeting. Both Lync users and web app users receive a full combined list of participants in the meeting.

Note: The "Add Participant" button on the Lync/Skype for Business client does not work in ad hoc dual homed conferences. Do not use the "Meet Now" button as a workaround, as this will leave an active call between the Meeting Server and the AVMCU.

Lync participants can also directly dial into a Meeting Server space or use drag and drop to add a Meeting Server space to a Lync meeting. These are useful if a large meeting is being held in a Cisco Meeting Server space which the Lync user wants to join. In the first case they will receive a composed layout of multiple participants. When adding a complete space to a Lync meeting, the Lync user will receive only one video stream from the space (the main speaker) and will not receive a full combined participant list. They can continue to add additional Lync participants as normal.

Note: Dual-homed conferences with a Meeting Server cluster are not currently supported with Expressway X8.11 as the edge for the Meeting Server, unless at least some of the Microsoft traffic flows directly between one of the Meeting Servers in the cluster and the Microsoft infrastructure (and not through Expressway). Dual-homing is supported with Expressway X8.11 as the edge for standalone Meeting Servers.

E.2 Consistent meeting experience in dual homed conferences

The Meeting Server sends two H.264 video streams stream per video participant to the AVMCU, a high resolution video stream and a low resolution video stream, see Figure 24. Lync, Skype for Business and O365 clients that support the high resolution, subscribe to and receive the high quality video stream. Clients that select a lower quality, because of bandwidth restrictions, window size, layout, CPU power or being on a mobile device, subscribe to and receive the lower quality streams, and do not reduce the video quality nor degrade the video experience for other participants.

Note: Ensure that the bandwidth of the SIP trunk is set sufficiently high to accommodate the two video streams. We recommend 8MB for LANs and 2.5MB for WANs.

Figure 24: Dual media streams to AVMCU

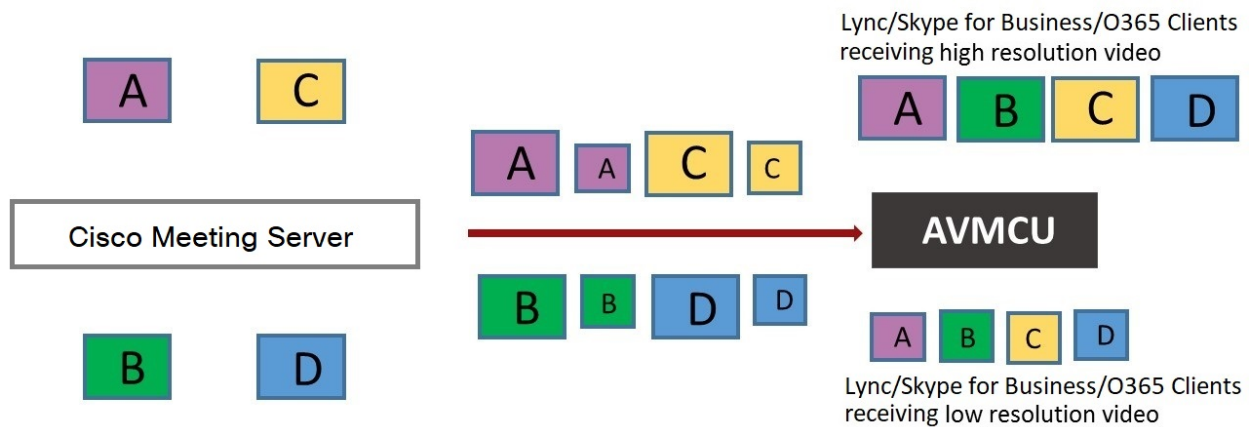

Note: Any devices using Microsoft RTVideo will not benefit from this feature.

E.2.1 Summary of user experiences

Dual homed conferencing combined with support for RDP and multiple video encoders, results in a richer meeting experience for both Lync and web app users.

- Both Lync client users and web app users see familiar screen layouts.
- Both Lync client users and web app users receive a full combined list of all participants in the meeting, regardless of where they are connected.
- Lync client users see a non-square aspect ratio for video from SIP endpoints and web apps.
- Lync client users see content in a separate area of their screen rather than in the main video area.
- The Meeting Server sends video using the best quality codec supported by each participant in Lync meetings. This optimizes the experience for all Lync client users in a meeting, when a mixture of Lync client versions are used by participants.

- The Meeting Server sends two H.264 video streams stream per video participant to the AVMCU, a high resolution video stream and a low resolution video stream, to preserve the high resolution experience for clients that support it, when clients that can only support low resolution join the meeting.
- Chat works in Lync AVMCU conferences with web app users in spaces. and in direct calls between a web app user and a Lync client.

Note: For the best user experience during meetings, use Lync 2013, Skype for Business 2015 or later, which allow multiple video streams to be transmitted to the Meeting Server. This enables an endpoint or web app user connecting to the Meeting Server to view multiple Lync participants. Lync 2010 only provides a single loudest speaker stream, if the loudest speaker is on the Meeting Server side of the conference already, then web app users and SIP endpoint users will not view the Lync participants.

For more information on RDP and multiple video encoder support, see these FAQs:

- [RDP support](#),
- [multiple video encoder support](#).

E.3 Mute/unmute meeting controls in dual homed conferences

Version 2.4 of the Meeting Server software introduced improved mute/unmute meeting controls in dual homed conferences for:

- on-premise and Office 365 Lync/Skype for Business clients,
- end point users,
- web app users.

Note: This section assumes that muting and unmuting is enabled using the API of the Meeting Server.

Muting/unmuting:

- Lync clients can mute and unmute anyone in the dual homed conference, this means themselves and others, and they can mute and unmute the audience too.
- All endpoint users can now mute Lync clients,
- Endpoint users on the Lync side of the AVMCU can now mute and unmute themselves (self) and other endpoints (either on the Lync clients/endpoints connected to the AVMCU or on the Meeting Server side). Prior to version 2.4, only endpoint users on the Meeting Server side of the AVMCU could mute and unmute themselves (self) and others.

- For non-ActiveControl endpoints, the Meeting Server sends DTMF key sequences for each mute and unmute, and overlays an icon on the media stream to the endpoint to indicate whether the endpoint is muted or unmuted.
- For ActiveControl endpoints running CE 9.2.1 or later software, the endpoint handles the icons and messages (the Meeting Server does not overlay icons).
- Once an ActiveControl endpoint is muted it has to be unmuted locally so as to ensure the privacy of any local conversation. For example, when a remote participant mutes an ActiveControl endpoint and then tries to unmute it, the ActiveControl endpoint will mute itself again until it is locally unmuted.
- When a remote participant tries to unmute a non-ActiveControl endpoint, the non-ActiveControl endpoint will be unmuted.
- web app users and Cisco Meeting Management users can mute and unmute Lync clients. They also see the correct mute state of all participants in the meeting.

Muting/unmuting web app users:

- Information on local muting and unmuting of a web app user is not passed to Lync clients in dual homed conferences. However, if a Lync client remotely mutes a web app user and the web app unmutes itself, the Meeting Server tells the Lync clients about the unmuting.
- When a remote participant tries to unmute a web app user, the web app user will remain locally muted. Note: other participants will still see them as unmuted, although they are actually muted.
- The web app shows the mute/unmute state using its own icons. Meeting Server icons are not overlaid on the web app video pane.

E.4 Configuring the Dual Homed Lync functionality

If you already have an on-prem Lync deployment or Lync Federation deployment working with the Meeting Server deployment, then no additional configuration is required on the Meeting server.

If this is a new deployment, then make sure that you configure the Lync Edge settings on the Meeting Server, see [Section 8.5](#).

E.4.1 Troubleshooting

If users are unable to join a Lync conference via the IVR or using a dial plan rule that resolves to “Lync”, the first thing to do is to verify that the “Lync Edge” settings have been set up - the same mechanism is used to resolve Lync conferences as is used to find the Edge server. The Meeting Server must query the Lync FE server to find both of these.

If this fails, a message will be logged in the event log to say that the conference ID cannot be found:

lync conference resolution: conference "1234" not found

This may mean that the conference does not exist, but there are also other possible causes.

If SIP traffic tracing is enabled, there should be a 'SERVICE' message sent to the Lync FE server just before the above message is logged, which should be replied to with a 200 OK. Check that this message is sent to the correct IP, which should be that of a Lync FE server.

If this message is not sent (it does not show up in the logs), then it is possible that the Call Bridge is unable to find the Lync server using a DNS SRV lookup for the `_sipinternaltls._tcp.lyncdomain` record, and so does not know where to send it. Enabling DNS tracing and retrying should confirm this. However this can also happen if the Lync Edge settings have not been configured on the Meeting Server.

If the Service message is sent but the Lync server replies with "403 unauthorized", then the most likely cause of this is that the local contact domain in the outbound dial plan rule for this Lync domain is not set correctly. It should be set to the FQDN of the Meeting Server, which should be the same as the FQDN supplied in the CN of the Call Bridge's certificate.

Appendix F More information on LDAP field mappings

This section provides additional information for LDAP field mappings that you set up for the Meeting Server.

Parts of an LDAP field value can be substituted by means of a sed-like construction, as follows:

```
<LDAP field name>|'/<regex>/<replacement format>/<option>'</b>
```

where:

- <option>** can be **g**, to replace every match of **<regex>** with **<replacement format>**, or blank to match only the first

- parts of **<regex>** can be tagged for use in **<replacement format>** by enclosing them in round brackets

- tagged matches can be referenced in **<replacement format>** as **\x** where **x** is a digit from 0 to 9. Match 0 corresponds to the entire match, and matches 1-9 the 1st to 9th tagged sub-expressions

- single quotes inside the substitution expression must be escaped with a backslash, as must backslash characters themselves

- any character other than a single quote, a backslash, or the digits 0-9 can be used in place of the forward slash that separates the components of the substitution expression

- if the separating character is to be used as a literal within the expression, it must be escaped with a backslash.

As an example, the following would convert addresses in the format:

```
firstname.lastname@test.example.com
```

into the format:

```
firstname.lastname@example.com JIDs
```

```
$mail|'/@test/@xmpp/'</b>
```

and the following would remove every lower case 'a' from the user's full name:

```
$cn|'/a//g'</b>
```

A sensible set of expressions for use might be:

```
Full name:           $cn$  
JID:                 $mail|'/@test/'</b>
```

```
space URI:          $mail|'/@.*//'</b>
```

```
space dial-in number: $ipPhone$
```

Note: The LDAP server credentials are used to read the following fields (for security reasons you may want to restrict the fields and permissions available using those credentials):

- mail
 - objectGUID
 - entryUUID
 - nsuniqueid
 - telephoneNumber
 - mobile
 - sn
 - givenName
-

Appendix G Using TURN servers behind NAT

The TURN server can be deployed behind a NAT, and the NAT address specified using the MMP command `turn public-ip`. However, due to how Interactive Connectivity Establishment (ICE) works, careful configuration of the NAT is required to ensure connectivity always works.

This appendix provides an overview of how ICE works. It explains:

- how candidates are identified,
- how connectivity is checked,
- the effect of NAT in front of the TURN server,
- how NAT affects external web app users.

Note: Issues can arise when the only available path includes both relay candidates. This requires the firewall to be correctly configured, so that all clients are able to send and receive video and audio.

G.1 Identifying candidates

ICE works by gathering a list of candidate addresses and ports, and then finding which pairs of these candidates allow media to be exchanged. When multiple candidate pairs are available then a priority scheme is used to determine which pair is used.

Typically, three candidates might exist:

1. Host candidate
2. Server Reflexive candidate
3. Relay candidate

G.1.1 Host candidate

The most simple candidate is the host candidate. This is the address used by the host interface. This is often on a local network and not routable.

G.1.2 Server Reflexive candidate

The server reflexive candidate is the address that the TURN server sees incoming packets coming from. To determine this, the host sends packets to a defined port on the TURN server (normally port 3478) and the TURN server replies with information about where the packets came from.

Figure 25: Server Reflexive candidate

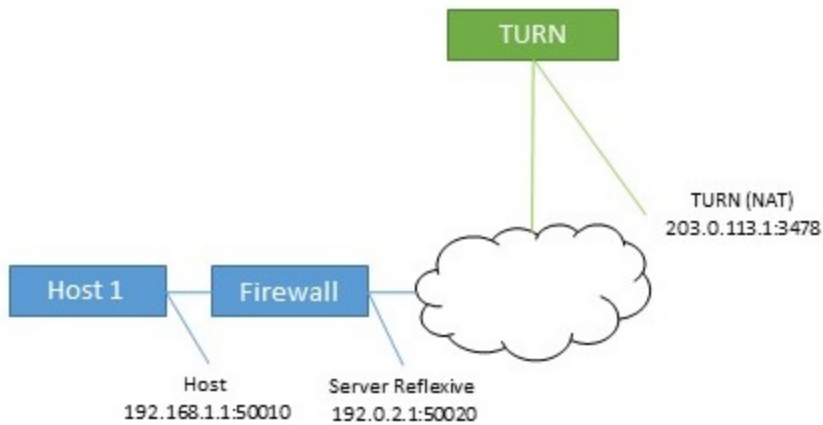

In cases where the host is behind a firewall carrying out NAT, then this is different to the host candidate. In many cases, packets sent to this port and address will be forwarded back to the host.

Figure 26: Effect of a host behind a firewall carrying out NAT

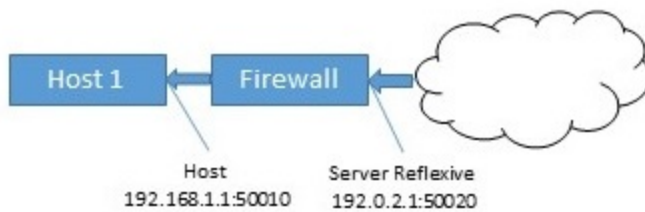

G.1.3 Relay candidate

The final candidate is the relay candidate. This candidate is created by the TURN server in response to requests from the host. The relay address of this candidate is the TURN server interface address, when NAT is used the relay address is changed to an address from NAT.

Figure 27: Relay candidate

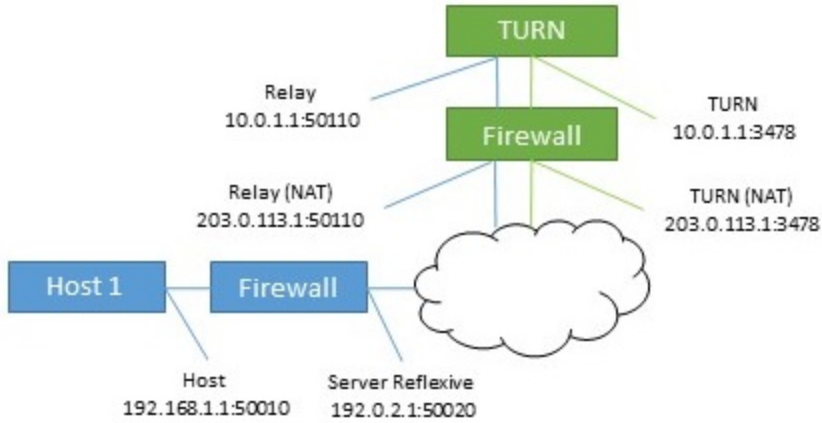

Data sent to this relay address is then sent back to the host via the TURN server.

Figure 28: TURN server returns relay address to host

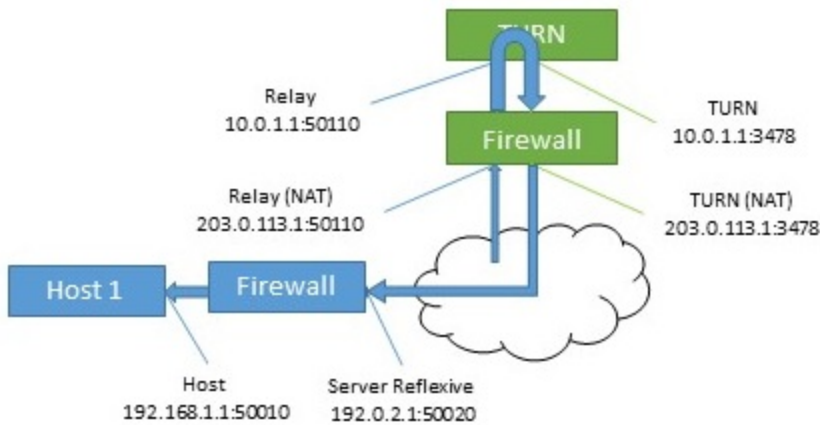

This relay candidate has a second use. It can also be used by the host to send packets to the far end. This occurs when there is no other path possible. Note that these packets come from the TURN server itself, so will only get their NAT address when rewritten by the firewall.

Figure 29: Host sending packets to the far end

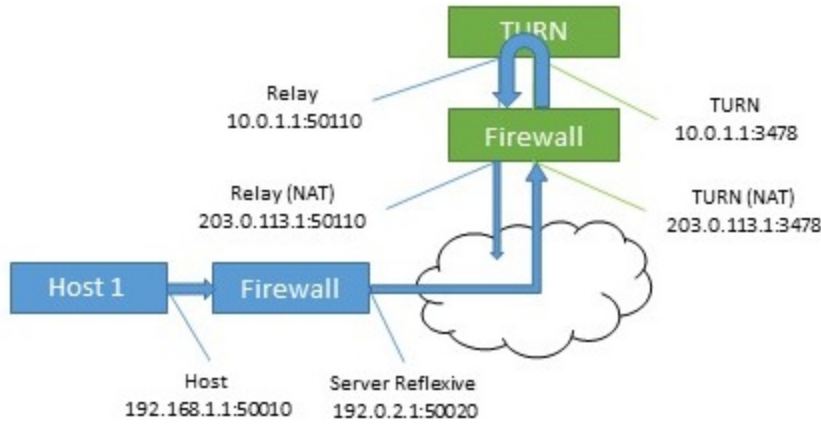

G.2 Checking connectivity

Once candidates are known then connectivity checks are undertaken. Each host tries to contact the far end host, server reflexive and relay addresses directly. It then also uses its relay to attempt connections to the same far end candidates.

Table 27: Candidates for two hosts (using same TURN server)

Host	Type	Address:port
1	Host	192.168.1.1:50010
1	Server Reflexive	192.0.2.1:50020
1	Relay	203.0.113.1:50110
2	Host	172.16.1.1:50100
2	Server Reflexive	198.51.100.1:50040
2	Relay	203.0.113.1:50510

Table 28: Candidate pairs formed by host 1

Source	Destination Type	Destination address
Host (192.168.1.1:50010)	Host	172.16.1.1:50100
Host (192.168.1.1:50010)	Server Reflexive	198.51.100.1:50040
Host (192.168.1.1:50010)	Relay	203.0.113.1:50510
Relay (10.0.1.1:50110)	Host	172.16.1.1:50100

Source	Destination Type	Destination address
Relay (10.0.1.1:50110)	Server Reflexive	198.51.100.1:50040
Relay (10.0.1.1:50110)	Relay	203.0.113.1:50510

Typically, the relay addresses are only required when the hosts have limited network access. For example, a user in a coffee shop or hotel may not be able to access any higher numbered ports.

When both hosts have restricted access then a path that involves both relay candidates can be formed. In this case, the traffic flows out of one relay candidate and into the other before being forwarded on to the far end.

Figure 30: Host to host media path using relay to relay path (no NAT)

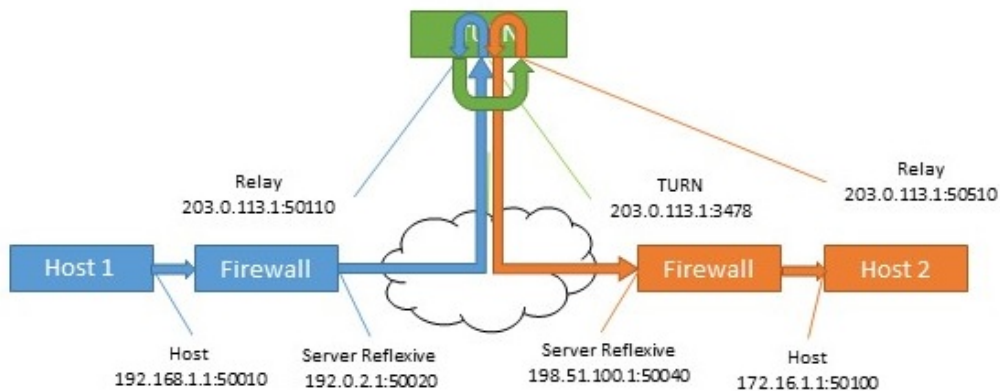

G.3 NAT in front of the TURN server

When NAT is present in front of the TURN server, the flow becomes more complicated. The relay candidates are expecting to receive traffic from one of the other hosts candidates. If the packets are sent from the TURN server's interface, and are not rewritten by the firewall, then they will appear to be coming from an unknown address. This prevents a successful connectivity check and in cases where the other paths are not available, there are no routes for media to take.

Figure 31: Host to host media path using relay to relay path (with NAT)

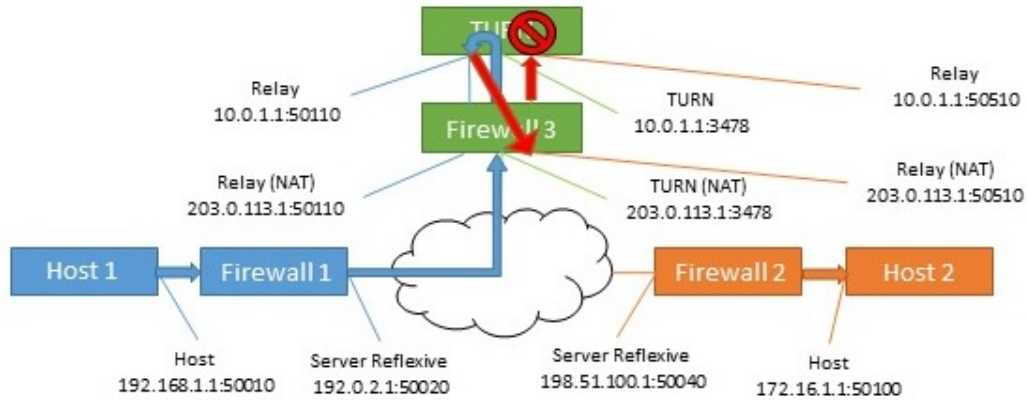

Table 29: Host to host media path using relay to relay path (with NAT)

Source address (in packets)	Destination	Action at destination
192.168.1.1:50010	203.0.113.1:3478 via Firewall	Firewall 1 rewrites source address
192.0.2.1:50020	203.0.113.1:3478	Firewall 3 rewrites destination address and forwards to the TURN server
192.0.2.1:50020	10.0.1.1:3478	TURN server internally maps this to the relay address for this source, and sends to far end's relay.
10.0.1.1:50110	203.0.113.1:50510 via Firewall	Firewall 3 rewrites destination address
10.0.1.1:50110	10.0.1.1:50510	TURN server sees unexpected source address and drops traffic.

The solution for this is known as hairpin NAT, loopback NAT or NAT reflection. In this the source address of the traffic is rewritten as well as the destination. The source address is then the address of the firewall, which means it matches one of the candidates.

Table 30: Host to host media path using relay to relay path (with hairpin NAT)

Source address (in packets)	Destination	Action at destination
192.168.1.1:50010	203.0.113.1:3478 via Firewall	Firewall 1 rewrites source address
192.0.2.1:50020	203.0.113.1:3478	Firewall 3 rewrites destination address and forwards to the TURN server.

Source address (in packets)	Destination	Action at destination
192.0.2.1:50020	10.0.1.1:3478	TURN server internally maps this to the relay address for this source, and sends to far end's relay.
10.0.1.1:50110	203.0.113.1:50510 via Firewall	Firewall 3 rewrites both source and destination addresses.
203.0.113.1:50110	10.0.1.1:50510	TURN server internally maps traffic from relay to assigned host.
10.0.1.1:3478	198.51.100.1:50040 via Firewall	Firewall 3 rewrites source address.
203.0.113.1:3478	198.51.100.1:50040	Firewall 2 rewrites destination address.
203.0.113.1:3478	172.16.1.1:50100	Arrives at final destination.

For details on how to enable this functionality, refer to your firewall documentation.

Appendix H Using a standby Meeting Server

The instructions in this appendix apply to virtualized deployments, including the Cisco Meeting Server 1000.

H.1 Backing up the currently used configuration

1. Establish an SSH connection to the currently used Meeting Server using an SSH utility such as OpenSSH or PuTTY.

2. Issue the command:

```
backup snapshot <name>
```

This backup includes IP addresses, passwords and certificates into a file called <name>.bak. We recommend using a name in the format servername_date (for example, test_server_2014_09_04).

A successful backup creation returns:

```
cms> backup snapshot test_server_2014_09_04.bak ready for download
```

3. Download the backup file using an SFTP client (e.g. WinSCP).

Note: We recommend backing up your Meeting Server regularly, e.g. once a day and that you store copies of the backup externally to the Meeting Server and the standby server.

H.2 Transferring a backup to the standby server

We recommend that you keep the standby sever running at all times.

1. Copy all the certificates and the cms.lic file from the standby server in case they differ from the original server that the backup was created on. Store them somewhere safe.
2. Establish an SFTP connection with the standby server.
3. Upload the previously saved backup file on to the standby server.
4. Issue the MMP backup list command to confirm that the backup file was successfully uploaded. This should return something similar to:

```
cms> backup list test_server_2014_09_
```

5. Enter the following command and confirm to restore from the backup file:

```
backup rollback <name>
```

This overwrites the existing configuration and reboots the Meeting Server. Therefore a warning message is displayed. The confirmation is case sensitive and you must press upper case **Y**, otherwise the operation will be aborted.

Note: It is not possible to create a backup from one type of deployment and roll it back on the other type, for example, from a virtualized Meeting Server 1000 to a Meeting Server 2000, and vice versa.

A successful operation returns:

```
[cms> backup list
Jul 23 09:42 test_2020_07_23
[cms> backup rollback test_2020_07_23
WARNING!!!
This command will overwrite the existing system configuration
and result in a reboot of the system. This will cause
an interruption in service.

Are you sure you wish to proceed? (Y/n)
Successful backup extraction
Stopping Application monitor: app_monitor.
Rebooting system...
```

Relevant only to Smart Licensing users: When you restore from the backup, everything is overwritten including the IP address and certificates. Therefore if you are restoring onto a different server from the one that the backup was made on, you must manually copy any certificates that are not valid on the new server.

1. Establish an SFTP connection with the standby server
2. If necessary:
 - a. Put back any certificates and private keys (if the restored versions are not valid on the standby server).
 - b. Assign these certificates to their corresponding services using the following commands:

```
callbridge certs nameofkey nameofcertificate
webbridge3 https certs nameofkey nameofcertificate
webbridge3 c2w certs nameofkey nameofcertificate
webadmin certs nameofkey nameofcertificate
webbridge trust nameofcallbridgecertificate
```

- c. Restart any service for which you changed the certificate

```
callbridge restart
webbridge3 restart
webadmin restart
```

After the new server has fully booted up, it will be fully operational, and will take over the services of the original server.

Appendix I Web Admin Interface – Configuration menu options

The **Configuration** tab on the Call Bridge's Web Admin interface allows you to configure the following options:

- [General](#)
- [Active Directory](#)
- [Call settings](#)
- [Outbound calls and Incoming calls](#)
- [CDR settings](#)
- [Spaces](#)
- [API](#)

I.1 General

Use the **Configuration > General** page to set up and configure:

- **TURN server settings.** Use these settings to allow the Call Bridge and external clients to access the TURN server. See [Web Admin interface settings for the TURN server](#). Use MMP commands to configure the TURN server itself. See [Configuring the MMP](#).
- **Lync Edge settings.** Use these settings if you are integrating your Call Bridge with Lync Edge. See [Configuration on Meeting Server to use Lync Edge](#).
- **IVR.** Use these settings if you are using an Interactive Voice Response (IVR) to manually route to pre-configured calls, so callers are greeted by a prerecorded voice message inviting them to enter the ID number of the call or space that they want to join. See [IVR configuration](#).

I.2 Active Directory

If you want users to use web apps to connect to the Meeting Server, then you must have an LDAP server. The Meeting Server imports the User accounts from the LDAP server.

Note: You can use OpenLDAP and Oracle Internet Directory (LDAP version 3), however, this needs to be configured via the API—it cannot be configured through the Web Admin interface.

Use the **Configuration > Active Directory** page to set up the Meeting Server to work with Active Directory. See [LDAP configuration](#).

I.3 Call settings

Use the **Configuration > Call settings** page to:

- Allow media encryption for SIP calls (including Lync).
- Specify whether participant label overlays are shown on SIP calls.
- Specify the preferred size (in milliseconds) for outgoing audio packets; 10ms, 20ms, or 40ms.
- Enable TIP support. (You need to enable TIP support if you use endpoints such as the Cisco CTS range.)
- Allow presentation video channel operations—if this is set to **prohibited** then no content channel video or BFCP capability will be advertised to the far end.
- If presentation video channel operations are allowed for SIP calls, this setting determines the Call Bridge's BFCP behavior, one of:
 - **server role only**—this is the normal option for a conferencing device, and is intended for use with BFCP client mode devices (for instance, SIP endpoints).
 - or
 - **server and client role**—this option allows the Call Bridge to operate in either BFCP client or BFCP server mode in calls with remote devices.

This setting allows improved presentation video sharing with a remote conference-hosting device.

- Set the value for the Resource-Priority header field in outgoing SIP calls. This setting tells the Meeting Server how much priority you will allow the bandwidth to allocate for presenting. This depends on the bandwidth capability of the network environment and other factors such as if there are any immersive systems that push HD, for example.
- Enable and disable UDP signaling for SIP. Set to one of:
 - **disabled|enabled**: disable if you use SIP over TCP, or require that all of your network traffic is encrypted.
 - **enabled, single address** mode corresponds to the SIP over UDP behavior in versions prior to 2.2 and is the default.
 - **enabled, multi address** if the Call Bridge is configured to listen on more than one interface.
- Enable Lync presence support. This setting determines whether or not this Call Bridge should supply information on destination URLs it serves to Lync presence subscribers.
- Leave the Lync packet pacing mode set to **default**. Do not change the setting to **delay** unless instructed to do so by Cisco Support.

Note: For more information on each field, you can use the hover-over text that displays for each individual field, or see [Dial plan configuration – SIP endpoints](#).

The **Call settings** page also allows you to change the bandwidth settings for SIP, Cisco Meeting Server (web app), Server reflexive, Relay, VPN, and Lync content. The settings are measured in bits-per-second, for example, 2000000 is 2Mbps. We dedicate at least 64kbps for audio, and recommend 2Mbps for a 720p30 call, or around 3.5Mbps for a 1080p30 call. More bandwidth would be required for 60fps.

You may need to change some of the bandwidth settings if you allow SIP media encryption, or enable TIP support, for example. In the case of 3 screen TIP calls, the bandwidth numbers seen on the **Call settings** page get automatically tripled, so you do not need to manually set them to 6Mbps for example. However, we would normally recommend (3x) 4Mbps for most CTS calls.

I.4 Outbound calls and Incoming calls

Use the **Configuration > Outbound calls / Incoming calls** pages to determine how the Meeting Server handles each call.

The **Outbound calls** page controls how outbound calls are handled; the **Incoming calls** page determines whether incoming calls are rejected, or matched and forwarded. If they are matched and forwarded, then information about how to forward them is required. The **Incoming calls** page has two tables—one to configure matching/rejection and the other to configure forwarding behavior.

For more information on completing these fields, see [Web Admin Interface configuration pages that handle calls](#).

I.5 CDR settings

Use the **Configuration > CDR settings** page to enter the URI of the CDR receivers.

The Meeting Server generates Call Detail Records (CDRs) internally for key call-related events, such as a new SIP connection arriving at the server, or a call being activated or deactivated. It can be configured to send these CDRs to a remote system to be collected and analyzed. You can not store records on a long-term basis on the Meeting Server, or browse CDRs on the Meeting Server.

For more information on completing these fields, see [Call Detail Record support](#) and the [Call Details Record Guide](#).

You can also use the API to configure the Meeting Server with the URI of the CDR receivers. See the [API Reference guide](#).

I.6 Spaces

Use the **Configuration > Spaces** page to create a space on the Meeting Server to dial into. This allows, for example, endpoints and web app to dial in.

Add a space with:

- **Name** for example. **Call 001**
- **URI** for example. **88001**

On this page you can also optionally specify Secondary URI user part, Call ID, Passcode, and Default Layout.

You can also use the API to create spaces. See the [API Reference guide](#).

Note: The Call ID parameter supports only a numeric value, therefore should be configured with a number.

I.7 API

From version 2.9, the API can be accessed using the Meeting Server Web Admin Interface rather than using API Methods and third-party applications. After logging in to the Web Admin interface, navigate to the **Configuration** tab and select **API** from the pull-down list. See Figure 32.

Figure 32: Accessing the API via the Meeting Server web admin interface

The screenshot displays the Cisco Meeting Server Web Admin Interface. At the top left is the Cisco logo. Below it is a navigation bar with tabs for Status, Configuration, Logs, and Debug. The user is logged in as 'admin'. The Configuration menu is open, showing a list of options: General, Active Directory, Call settings, Outbound calls, Incoming calls, Interactive Voice Response, CDR settings, Spaces, and API. The API option is highlighted. Below the menu, there is a section titled 'API objects' with a filter input field. A list of API endpoints is shown, including /api/v1/activeDirectory, /api/v1/callBrandingProfiles/<id>, /api/v1/callBridgeGroups/<id>, /api/v1/callBridges/<id>, /api/v1/callLegProfiles/<id>, /api/v1/callLegProfiles/<id>/usage, /api/v1/callLegs/<id>, /api/v1/callLegs/<id>/callLegProfileTrace, /api/v1/callLegs/<id>/cameraControl, /api/v1/callLegs/<id>/generateKeyframe, /api/v1/callProfiles/<id>, /api/v1/calls/<id>, /api/v1/calls/<id>/callLegs, /api/v1/calls/<id>/callLegs/<id>, and /api/v1/calls/<id>/diagnostics. On the right side of the API objects list, there are buttons for 'Allow delete' and 'Disallow delete', and a checkbox for 'Require delete confirmation' which is checked.

Note: To access the API via the web interface you still need to do the initial Meeting Server configuration settings and authentication using the MMP as you would if you were using a third party application.

Cisco Legal Information

THE SPECIFICATIONS AND INFORMATION REGARDING THE PRODUCTS IN THIS MANUAL ARE SUBJECT TO CHANGE WITHOUT NOTICE. ALL STATEMENTS, INFORMATION, AND RECOMMENDATIONS IN THIS MANUAL ARE BELIEVED TO BE ACCURATE BUT ARE PRESENTED WITHOUT WARRANTY OF ANY KIND, EXPRESS OR IMPLIED. USERS MUST TAKE FULL RESPONSIBILITY FOR THEIR APPLICATION OF ANY PRODUCTS.

THE SOFTWARE LICENSE AND LIMITED WARRANTY FOR THE ACCOMPANYING PRODUCT ARE SET FORTH IN THE INFORMATION PACKET THAT SHIPPED WITH THE PRODUCT AND ARE INCORPORATED HEREIN BY THIS REFERENCE. IF YOU ARE UNABLE TO LOCATE THE SOFTWARE LICENSE OR LIMITED WARRANTY, CONTACT YOUR CISCO REPRESENTATIVE FOR A COPY.

The Cisco implementation of TCP header compression is an adaptation of a program developed by the University of California, Berkeley (UCB) as part of UCB's public domain version of the UNIX operating system. All rights reserved. Copyright © 1981, Regents of the University of California.

NOTWITHSTANDING ANY OTHER WARRANTY HEREIN, ALL DOCUMENT FILES AND SOFTWARE OF THESE SUPPLIERS ARE PROVIDED "AS IS" WITH ALL FAULTS. CISCO AND THE ABOVE-NAMED SUPPLIERS DISCLAIM ALL WARRANTIES, EXPRESSED OR IMPLIED, INCLUDING, WITHOUT LIMITATION, THOSE OF MERCHANTABILITY, FITNESS FOR A PARTICULAR PURPOSE AND NONINFRINGEMENT OR ARISING FROM A COURSE OF DEALING, USAGE, OR TRADE PRACTICE.

IN NO EVENT SHALL CISCO OR ITS SUPPLIERS BE LIABLE FOR ANY INDIRECT, SPECIAL, CONSEQUENTIAL, OR INCIDENTAL DAMAGES, INCLUDING, WITHOUT LIMITATION, LOST PROFITS OR LOSS OR DAMAGE TO DATA ARISING OUT OF THE USE OR INABILITY TO USE THIS MANUAL, EVEN IF CISCO OR ITS SUPPLIERS HAVE BEEN ADVISED OF THE POSSIBILITY OF SUCH DAMAGES.

Any Internet Protocol (IP) addresses and phone numbers used in this document are not intended to be actual addresses and phone numbers. Any examples, command display output, network topology diagrams, and other figures included in the document are shown for illustrative purposes only. Any use of actual IP addresses or phone numbers in illustrative content is unintentional and coincidental.

All printed copies and duplicate soft copies of this document are considered uncontrolled. See the current online version for the latest version.

Cisco has more than 200 offices worldwide. Addresses and phone numbers are listed on the Cisco website at www.cisco.com/go/offices.

© 2024 Cisco Systems, Inc. All rights reserved.

Cisco Trademark

Cisco and the Cisco logo are trademarks or registered trademarks of Cisco and/or its affiliates in the U.S. and other countries. To view a list of Cisco trademarks, go to this URL:

www.cisco.com/go/trademarks. Third-party trademarks mentioned are the property of their respective owners. The use of the word partner does not imply a partnership relationship between Cisco and any other company. (1721R)